

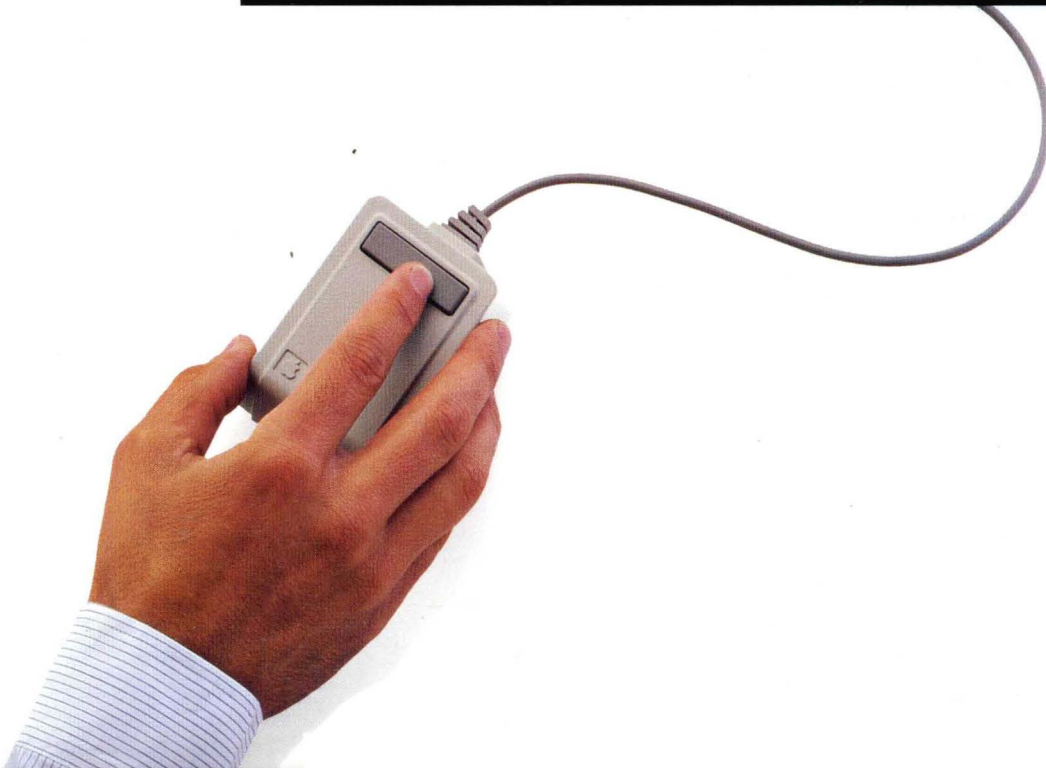

# Lisa Language

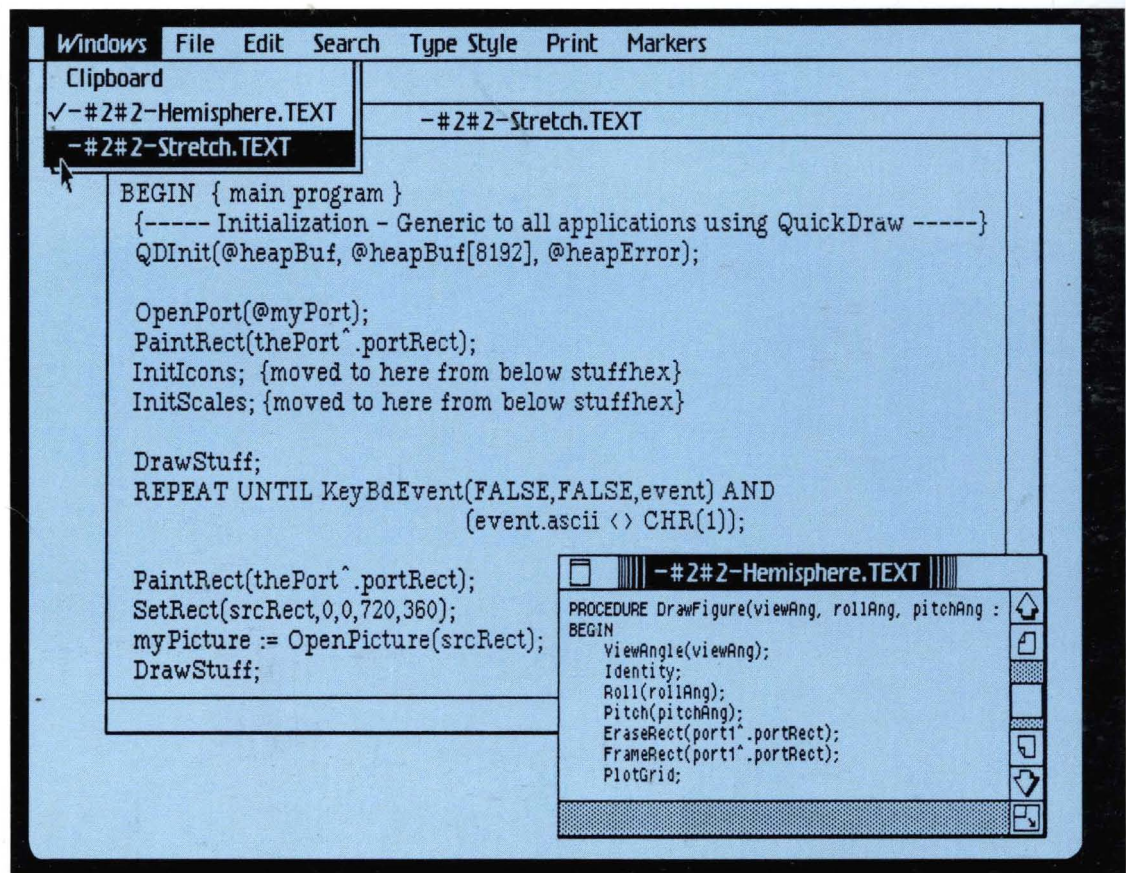

# Pascal Reference Manual



## **Copyright**

This manual and the software described in it are copyrighted with all rights reserved. Under the copyright laws, this manual or the software may not be copied, in whole or in part, without the written consent of Apple, except in the normal use of the software or to make a backup copy. The same proprietary and copyright notices must be affixed to any permitted copies as were affixed to the original. This exception does not allow copies to be made for others, whether or not sold, but all the material purchased (with all backup copies) may be sold, given, or loaned to another person. Under the law, copying includes translating into another language or format.

You may use the software on any computer owned by you, but extra copies cannot be made for this purpose. For some products, a multiuse license may be purchased to allow the software to be used on more than one computer owned by the purchaser, including a shared-disk system. (Contact your authorized Apple dealer for information on multiuse licenses.)

## **Licensing Requirements for Software Developers**

Apple has a low-cost licensing program, which permits developers of software for the Lisa to incorporate Apple-developed libraries and object codes into their products. Both in-house and external distribution require a license. Before distributing any products that incorporate Apple software, please contact Software Licensing at the address below for both licensing and technical information.

@1983, 1984 Apple Computer, Inc.  
20525 Mariani Ave.  
Cupertino, CA 95014  
(408) 996-1010

Apple, Lisa, ProFile, MacWorks, and the Apple logo are trademarks of Apple Computer, Inc.

Macintosh is a trademark licensed to Apple Computer, Inc.

Priam is a registered trademark of Priam, Inc. Sony is a registered trademark of Sony Corporation. Centronics is a registered trademark of Centronics Data Computer Corporation. VT52 and VT100 are trademarks of Digital Equipment Corporation.

Simultaneously published in the U.S.A. and Canada.

Reorder Apple Product #620-6139-B.



### **Limited Warranty on Media and Manuals**

If you discover physical defects in the media on which this software is distributed, or in the manuals distributed with the software, Apple will replace the media or manuals at no charge to you, provided you return the item to be replaced with proof of purchase to Apple or an authorized Apple dealer during the 90-day period after you purchased the software. In some countries the replacement period may be different; check with your authorized Apple dealer.

**ALL IMPLIED WARRANTIES ON THE MEDIA AND MANUAL, INCLUDING IMPLIED WARRANTIES OF MERCHANTABILITY AND FITNESS FOR A PARTICULAR PURPOSE, ARE LIMITED IN DURATION TO NINETY (90) DAYS FROM THE DATE OF THE ORIGINAL RETAIL PURCHASE OF THE PRODUCT.**

Even though Apple has tested the software and reviewed the documentation, **APPLE MAKES NO WARRANTY OR REPRESENTATION, EITHER EXPRESS OR IMPLIED, WITH RESPECT TO THIS SOFTWARE, ITS QUALITY, PERFORMANCE, MERCHANTABILITY, OR FITNESS FOR A PARTICULAR PURPOSE. AS A RESULT, THIS SOFTWARE IS SOLD "AS IS," AND YOU, THE PURCHASER, ARE ASSUMING THE ENTIRE RISK AS TO ITS QUALITY AND PERFORMANCE.**

**IN NO EVENT WILL APPLE BE HELD LIABLE FOR DIRECT, INDIRECT, SPECIAL, INCIDENTAL, OR CONSEQUENTIAL DAMAGES RESULTING FROM ANY DEFECT IN THE SOFTWARE OR ITS DOCUMENTATION,** even if advised of the possibility of such damages. In particular, Apple shall have no liability for any programs or data stored in or used with Apple products, including the costs of recovering such programs or data.

**THE WARRANTY AND REMEDIES SET FORTH ABOVE ARE EXCLUSIVE AND IN LIEU OF ALL OTHERS, ORAL OR WRITTEN, EXPRESS OR IMPLIED.** No Apple dealer, agent, or employee is authorized to make any modification, extension, or addition to this warranty.

Some states do not allow the exclusion or limitation of implied warranties or liability for incidental or consequential damages, so the above limitation or exclusion may not apply to you. This warranty gives you specific legal rights, and you may also have other rights which vary from state to state.

# Contents

## Chapter 1

### Tokens and Constants

1.1	Character Set and Special Symbols .....	1-1
1.2	Identifiers .....	1-2
1.3	Directives .....	1-2
1.4	Numbers .....	1-2
1.5	Labels .....	1-4
1.6	Quoted String Constants .....	1-4
1.7	Constant Declarations .....	1-5
1.8	Comments and Compiler Commands .....	1-5

## Chapter 2

### Blocks, Locality, and Scope

2.1	Definition of a Block .....	2-1
2.2	Rules of Scope .....	2-3

## Chapter 3

### Data Types

3.1	Simple-Types (and Ordinal-Types) .....	3-2
3.2	Structured-Types .....	3-7
3.3	Pointer-Types .....	3-13
3.4	Identical and Compatible Types .....	3-13
3.5	The Type-Declaration-Part .....	3-16

## Chapter 4

### Variables

4.1	Variable-Declarations .....	4-1
4.2	Variable-References .....	4-1
4.3	Qualifiers .....	4-2

## Chapter 5

### Expressions

5.1	Operators .....	5-4
5.2	Function-Calls .....	5-10
5.3	Set-Constructors .....	5-11

**Chapter 6**  
**Statements**

6.1 Simple Statements .....6-1  
6.2 Structured-Statements .....6-4

**Chapter 7**  
**Procedures and Functions**

7.1 Procedure-Declarations .....7-1  
7.2 Function-Declarations .....7-4  
7.3 Parameters .....7-5

**Chapter 8**  
**Programs**

8.1 Syntax .....8-1  
8.2 Program-Parameters .....8-1  
8.3 Segmentation .....8-1

**Chapter 9**  
**Units**

9.1 Regular-Units .....9-1  
9.2 Intrinsic-Units .....9-4  
9.3 Units that Use Other Units .....9-4

**Chapter 10**  
**Input/Output**

10.1 Introduction to I/O ..... 10-1  
10.2 Record-Oriented I/O ..... 10-8  
10.3 Text-Oriented I/O ..... 10-9  
10.4 Untyped File I/O ..... 10-18

**Chapter 11**  
**Standard Procedures and Functions**

11.1 Exit and Halt Procedures ..... 11-1  
11.2 Dynamic Allocation Procedures ..... 11-1  
11.3 Transfer Functions ..... 11-4  
11.4 Arithmetic Functions ..... 11-5  
11.5 Ordinal Functions ..... 11-8  
11.6 String Procedures and Functions ..... 11-9  
11.7 Byte-Oriented Procedures and Functions ..... 11-11  
11.8 Packed Array of Char Procedures and Functions ..... 11-12

**Chapter 12****The Compiler**

12.1 Compiler Commands .....	12-1
12.2 Conditional Compilation .....	12-2
12.3 Optimization of If-Statements .....	12-5
12.4 Optimization of While-Statements and Repeat-Statements .....	12-6
12.5 Efficiency of Case-Statements .....	12-6

**Appendixes**

A Comparison to Apple II and Apple III Pascal .....	A-1
B Known Anomalies in the Compiler .....	B-1
C Syntax of the Language .....	C-1
D Floating-Point Arithmetic .....	D-1
E QuickDraw .....	E-1
F Hardware Interface .....	F-1
G Lisa Extended Character Set .....	G-1
H Error Messages .....	H-1
I Pascal Workshop Files .....	I-1
J Listing Formats .....	J-1

## Tables

5-1 Precedence of Operations .....	5-1
5-2 Binary Arithmetic Operations .....	5-4
5-3 Unary Arithmetic Operations (Signs) .....	5-4
5-4 Boolean Operations .....	5-6
5-5 Set Operations .....	5-6
5-6 Relational Operations .....	5-7
5-7 Pointer Operation .....	5-8
10-1 Combinations of File Variable Types with External File Species and Categories .....	10-3
A-1 Predefined Identifiers in the Lisa Pascal Compiler .....	A-4
D-1 Results of Addition and Subtraction on Infinities .....	D-3
D-2 Results of Multiplication and Division on Infinities .....	D-3

# Syntax Diagrams

## A, B

actual-parameter .....	5-10
actual-parameter-list .....	5-10
array-type .....	3-8
assignment-statement .....	6-1
base-type .....	3-13
block .....	2-1

## C

case .....	6-6
case-statement .....	6-5
compound-statement .....	6-4
conditional-statement .....	6-4
constant .....	1-5
constant-declaration .....	1-5
constant-declaration-part .....	2-2
control-variable .....	6-8

## D, E, F

digit-sequence .....	1-2
enumerated-type .....	3-6
expression .....	5-3
factor .....	5-1
field-declaration .....	3-10
field-designator .....	4-4
field-list .....	3-9
file-buffer-symbol .....	4-4
file-type .....	3-12
final-value .....	6-8
fixed-part .....	3-9
for-statement .....	6-8
formal-parameter-list .....	7-6
function-body .....	7-4
function-call .....	5-10
function-declaration .....	7-4
function-heading .....	7-4

**G, H, I**

goto-statement .....	6-3
hex-digit-sequence .....	1-2
identifier .....	1-2
identifier-list .....	3-6
if-statement .....	6-5
implementation-part .....	9-2
index .....	4-2
index-type .....	3-8
initial-value .....	6-8
interface-part .....	9-2

**L, M, O**

label .....	2-1, 6-1
label-declaration-part .....	2-1
member-group .....	5-11
ordinal-type .....	3-2
otherwise-clause .....	6-6

**P**

parameter-declaration .....	7-6
pointer-object-symbol .....	4-4
pointer-type .....	3-13
procedure-and-function-declaration-part .....	2-2
procedure-body .....	7-1
procedure-declaration .....	7-1
procedure-heading .....	7-1
procedure-statement .....	6-2
program .....	8-1
program-heading .....	8-1
program-parameters .....	8-1

**Q, R**

qualifier .....	4-2
quoted-character-constant .....	1-4
quoted-string-constant .....	1-4
real-type .....	3-2
record-type .....	3-9
regular-unit .....	9-1
repeat-statement .....	6-7
repetitive-statement .....	6-6
result-type .....	7-4

**S**

scale-factor .....	1-3
set-constructor .....	5-11
set-type .....	3-11
sign .....	1-3
signed-number .....	1-3
simple-expression .....	5-3
simple-statement .....	6-1
simple-type .....	3-2
size-attribute .....	3-5
statement .....	6-1
statement-part .....	2-2
string-character .....	1-4
string-type .....	3-5
structured-statement .....	6-4
structured-type .....	3-7
subrange-type .....	3-7

**T**

tag-field-type .....	3-10
term .....	5-2
type .....	3-1
type-declaration .....	3-1
type-declaration-part .....	2-2

**U**

unit-heading .....	9-1
unsigned-constant .....	5-2
unsigned-integer .....	1-3
unsigned-number .....	1-3
unsigned-real .....	1-3
uses-clause .....	8-1

**V, W**

variable-declaration .....	4-1
variable-declaration-part .....	2-2
variable-identifier .....	4-1
variable-reference .....	4-1
variant .....	3-10
variant-part .....	3-10
while-statement .....	6-7
with-statement .....	6-10







# Preface

This manual is intended for Pascal programmers. It describes an implementation of Pascal for the Lisa computer. The compiler and code generator translate Pascal source text to MC68000 object code.

The language is reasonably compatible with Apple II and Apple III Pascal. See Appendix A for a discussion of the differences between these forms of Pascal.

In addition to providing nearly all the features of standard Pascal, as described in the *Pascal User Manual and Report* (Jensen and Wirth), this Pascal provides a variety of extensions. These are summarized in Appendix A. They include 32-bit integers, an **otherwise** clause in **case** statements, procedural and functional parameters with type-checked parameter lists, and the **•** operator for obtaining a pointer to an object. The real arithmetic conforms to many aspects of the proposed IEEE standard for single-precision arithmetic.

## Operating Environment

The compiler will operate in any standard Lisa hardware configuration; this manual assumes the Workshop software environment.

## Related Documents

*Pascal User Manual and Report*, Jensen and Wirth, Springer-Verlag 1975.

*Workshop User's Guide for the Lisa*, Apple Computer, Inc. 1983.

Other Lisa documentation.

## Definitions

For the purposes of this manual the following definitions are used:

- *Error*: Either a run-time error or a compiler error.
- *Scope*: The body of text for which the declaration of an identifier or label is valid.
- *Undefined*: The value of a variable or function when the variable does not necessarily have a meaningful value of its type assigned to it.
- *Unspecified*: A value or action or effect that, although possibly well-defined, is not specified and may not be the same in all cases or for all versions or configurations of the system. Any programming construct that leads to an unspecified result or effect is not supported.

## Notation and Syntax Diagrams

All numbers in this manual are in decimal notation, except where hexadecimal notation is specifically indicated.

Throughout this manual, bold-face type is used to distinguish Pascal text from English text. For example, **sq(n div 16)** represents a fragment of a Pascal program. Sometimes the same word appears both in plain text and in

bold-face; for example, "The declaration of a Pascal procedure begins with the word **procedure**."

*Italics* are used when technical terms are introduced.

i>

Pascal syntax is specified by diagrams. For example, the following diagram gives the syntax for an identifier:

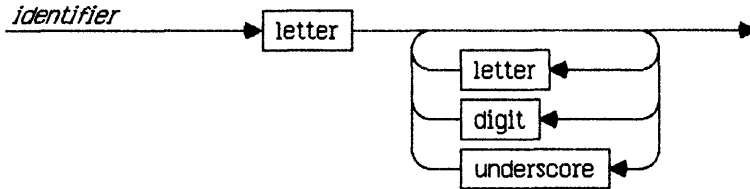

Start at the left and follow the arrows through the diagram. Numerous paths are possible. Every path that begins at the left and ends at the arrow-head on the right is valid, and represents a valid way to construct an identifier. The boxes traversed by a path through the diagram represent the elements that can be used to construct an identifier. Thus the diagram embodies the following rules:

- An Identifier must begin with a *letter*, since the first arrow goes directly to a box containing the name "letter."
- An Identifier might consist of nothing but a single letter, since there is a path from this box to the arrow-head on the right, without going through any more boxes.
- The Initial letter may be followed by another letter, a *digit*, or an *underscore*, since there are branches of the path that lead to these boxes.
- The Initial letter may be followed by any number of letters, digits, or underscores, since there is a loop in the path.

A word contained in a rectangular box may be a name for an atomic element like "letter" or "digit," or it may be a name for some other syntactic construction that is specified by another diagram. The name in a rectangular box is to be replaced by an actual instance of the atom or construction that it represents, e.g. "3" for "digit" or "counter" for "variable-reference".

Pascal *symbols*, such as reserved words, operators, and punctuation, are bold-face and are enclosed in circles or ovals, as in the following diagram for the construction of a compound-statement:

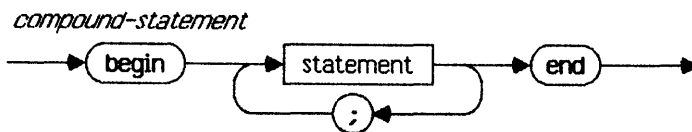

Text in a circle or oval represents itself, and is to be written as shown (except that capitalization of letters is not significant). In the diagram above, the semicolon and the words **begin** and **end** are symbols. The word "statement" refers to a construction that has its own syntax diagram.

A compound-statement consists of the reserved word **begin**, followed by any number of statements separated by semicolons, followed by the reserved word **end**. (As will be seen in Chapter 6, a statement may be null; thus **begin end** is a valid compound-statement.)



# Chapter 1

## Tokens and Constants

1.1	Character Set and Special Symbols .....	1-1
1.2	Identifiers .....	1-2
1.3	Directives .....	1-2
1.4	Numbers .....	1-2
1.5	Labels .....	1-4
1.6	Quoted String Constants .....	1-4
1.6.1	Quoted Character Constants .....	1-4
1.7	Constant Declarations .....	1-5
1.8	Comments and Compiler Commands .....	1-5





# Tokens and Constants

*Tokens* are the smallest meaningful units of text in a Pascal program; structurally, they correspond to the words in an English sentence. The tokens of Pascal are classified into *special symbols*, *identifiers*, *numbers*, *labels*, and *quoted string constants*.

The text of a Pascal program consists of tokens and *separators*; a separator is either a *blank* or a *comment*. Two adjacent tokens must be separated by one or more separators, if both tokens are identifiers, numbers, or reserved words.

No separators can be embedded within tokens, except in quoted string constants.

## 1.1 Character Set and Special Symbols

The character set used by Pascal on the Lisa is 8-bit extended ASCII, with characters represented by numeric codes in the range from 0 to 255.

Letters, digits, hex-digits, and blanks are subsets of the character set:

- The *letters* are those of the English alphabet, A through Z and a through z.
- The *digits* are the Arabic numerals 0 through 9; the *hex-digits* are the Arabic numerals 0 through 9, the letters A through F, and the letters a through f.
- The *blanks* are the space character (ASCII 32), the horizontal tab character (ASCII 9), and the CR character (ASCII 13).

*Special symbols* and *reserved words* are tokens having one or more fixed meanings. The following single characters are special symbols:

+ - \* / = < > [ ] . , ( ) : ; ^ @ { } \$

The following character pairs are special symbols:

<> <= >= := .. (\* \*)

The following are the *reserved words*:

and	end	label	program	until
array	file	methods*	record	uses
begin	for	mod	repeat	var
case	function	nil	set	while
const	goto	not	string	with
creation*	if	of	subclass*	
div	implementation	or	then	
downto	in	otherwise	to	
do	interface	packed	type	
else	intrinsic*	procedure	unit	

The reserved words marked with asterisks are reserved for future use. Corresponding upper and lower case letters are equivalent in reserved words. Only the first 8 characters of a reserved word are significant.

1.2 Identifiers

Identifiers serve to denote constants, types, variables, procedures, functions, units and programs, and fields in records. Identifiers can be of any length, but only the first 8 characters are significant. Corresponding upper and lower case letters are equivalent in identifiers.

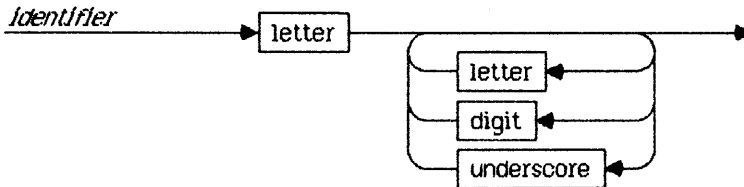

NOTE

The first 8 characters of an identifier must not match the first 8 characters of a reserved word.

Examples of Identifiers:

X Rome gcd SUM get\_byte

1.3 Directives

Directives are words that have special meanings in particular contexts. They are not reserved and can be used as identifiers in other contexts. For example, the word `forward` is interpreted as a directive if it occurs immediately after a procedure-heading or function-heading, but in any other position it is interpreted as an identifier.

1.4 Numbers

The usual decimal notation is used for numbers that are constants of the data types `integer`, `longint`, and `real` (see Section 3.1.1). Also, a hexadecimal `integer` constant uses the `$` character as a prefix (1-4 digits for `integer`, 5-8 digits for `longint`).

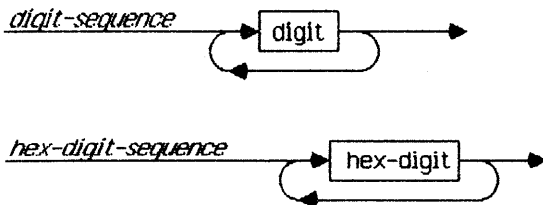

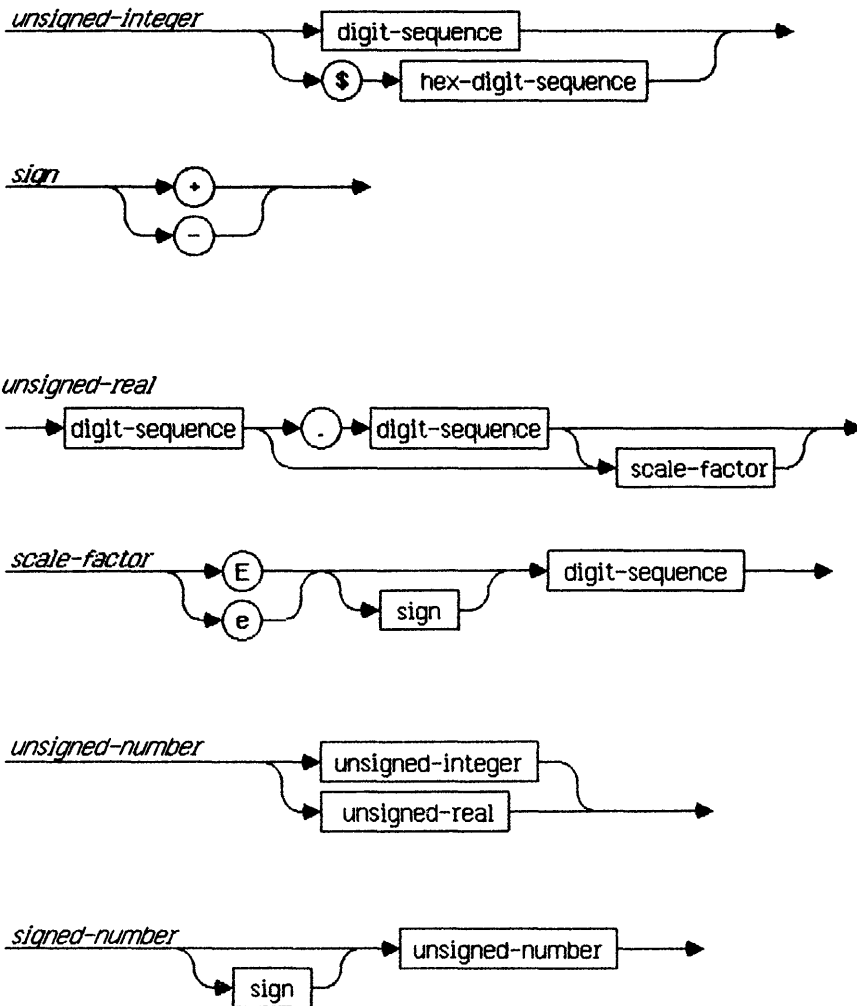

The letter E or e preceding the scale in an unsigned-real means "times ten to the power of".

Examples of numbers:

1    +100    -0.1    5E-3    87.35e+8    \$A05D

Note that 5E-3 means  $5 \times 10^{-3}$ , and 87.35e+8 means  $87.35 \times 10^8$ .

1.5 Labels

A label is a digit-sequence in the range from 0 through 9999.

1.6 Quoted String Constants

A quoted-string-constant is a sequence of zero or more characters, all on one line of the program source text and enclosed by apostrophes. Currently, the maximum number of characters is 255. A quoted-string-constant with nothing between the apostrophes denotes the null string.

If the quoted-string-constant is to contain an apostrophe, this apostrophe must be written twice.

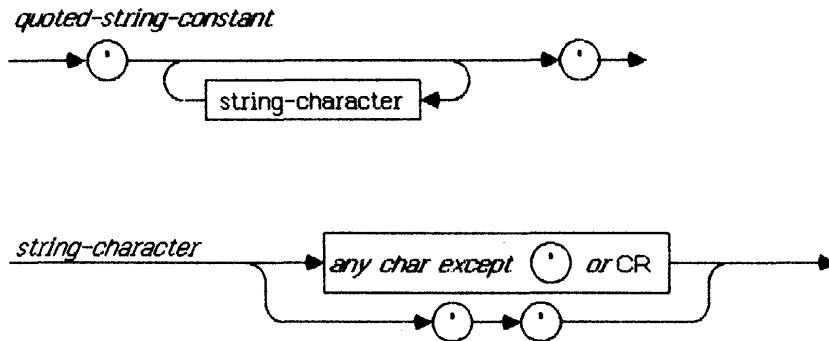

Examples of quoted-string-constants:

'Pascal'    'THIS IS A STRING'    'Don''t worry!'  
 'A'        ';'        '....'        ''

All string values have a *length* attribute (see Section 3.1.1.6). In the case of a string constant value the length is fixed; it is equal to the actual number of characters in the string value.

1.6.1 Quoted Character Constants

Syntactically, a quoted-character-constant is simply a quoted-string-constant whose length is exactly 1.



A quoted-character-constant is compatible with any char-type or string-type; that is, it can be used either as a character value or as a string value.

### 1.7 Constant Declarations

A constant-declaration defines an identifier to denote a constant, within the block that contains the declaration. The scope of a constant-identifier (see Chapter 2) does not include its own declaration.

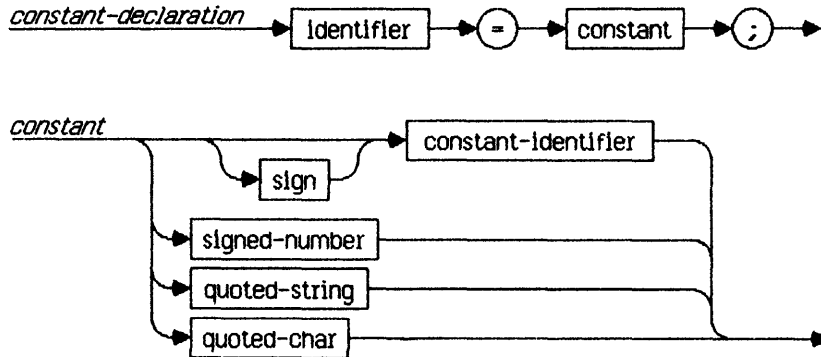

---

#### NOTE

A constant-identifier is an identifier that has already been declared to denote a constant.

---

A constant-identifier following a sign must denote a value of type **integer**, **longint**, or **real**.

### 1.8 Comments and Compiler Commands

The constructs:

```

{ any text not containing right-brace }
(* any text not containing star-right-paren *)
  
```

are called *comments*.

A compiler command is a comment that contains a \$ character immediately after the { or (\* that begins the comment. The \$ character is followed by the mnemonic of the compiler command (see Chapter 12).

Apart from the effects of compiler commands, the substitution of a blank for a comment does not alter the meaning of a program.

A comment cannot be nested within another comment formed with the same kind of delimiters. However, a comment formed with {...} delimiters can be nested within a comment formed with (\*...\*) delimiters, and vice versa.





# Chapter 2

## Blocks, Locality, and Scope

2.1	Definition of a Block .....	2-1
2.2	Rules of Scope .....	2-3
2.2.1	Scope of a Declaration .....	2-3
2.2.2	Redeclaration in an Enclosed Block .....	2-3
2.2.3	Position of Declaration within Its Block .....	2-3
2.2.4	Redeclaration within a Block .....	2-3
2.2.5	Identifiers of Standard Objects .....	2-4



# Blocks, Locality, and Scope

## 2.1 Definition of a Block

A *block* consists of declarations and a statement-part. Every block is part of a procedure-declaration, a function-declaration, a program, or a unit. All identifiers and labels that are declared in a particular block are *local* to that block.

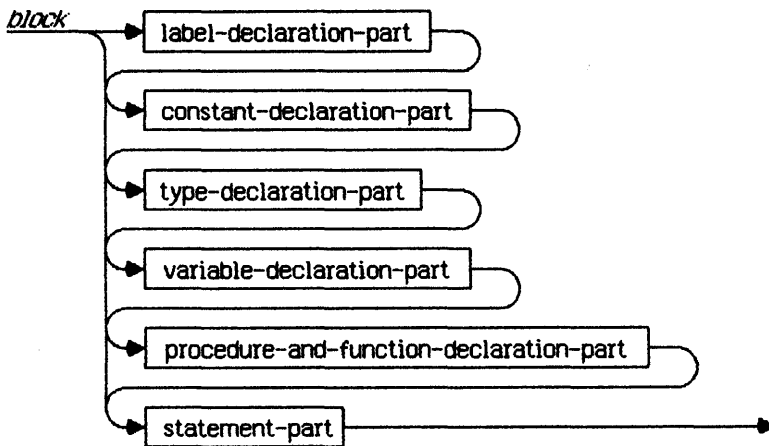

The *label-declaration-part* declares all labels that mark statements in the corresponding statement-part. Each label must mark exactly one statement in the statement-part.

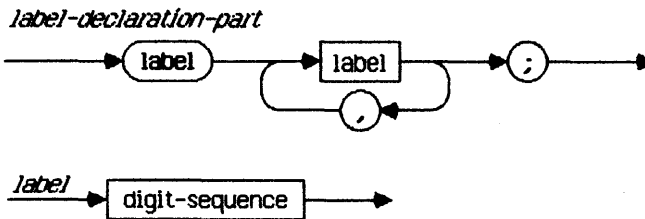

The *constant-declaration-part* contains all constant-declarations local to the block.

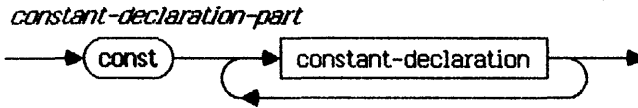

The *type-declaration-part* contains all type-declarations local to the block.

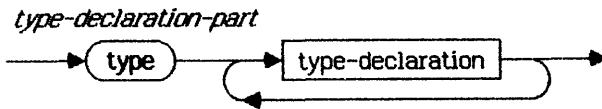

The *variable-declaration-part* contains all variable-declarations local to the block.

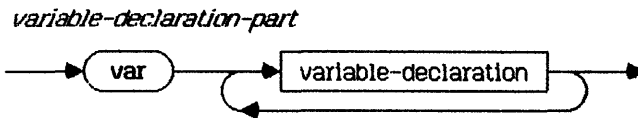

The *procedure-and-function-declaration-part* contains all procedure and function declarations local to the block.

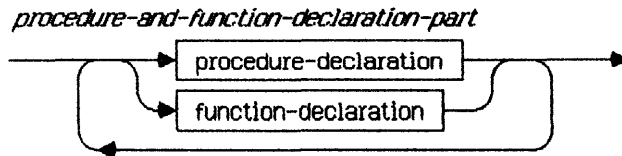

The *statement-part* specifies the algorithmic actions to be executed upon an activation of the block.

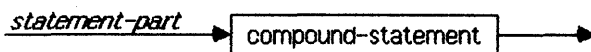

---

**NOTE**

---

At run time, all variables declared within a particular block have unspecified values each time the statement-part of the block is entered.

---

**2.2 Rules of Scope**

This chapter discusses the scope of objects *within the program or unit in which they are defined*. See Chapter 9 for the scope of objects defined in the interface-part of a unit and referenced in a host program or unit.

**2.2.1 Scope of a Declaration**

The appearance of an identifier or label in a declaration defines the identifier or label. All corresponding occurrences of the identifier or label must be within the *scope* of this declaration.

This scope is the block that contains the declaration, and all blocks enclosed by that block except as explained in Section 2.2.2 below.

**2.2.2 Redeclaration in an Enclosed Block**

Suppose that **outer** is a block, and **inner** is another block that is enclosed within **outer**. If an identifier declared in block **outer** has a further declaration in block **inner**, then block **inner** and all blocks enclosed by **inner** are excluded from the scope of the declaration in block **outer**. (See Appendix B for some odd cases.)

**2.2.3 Position of Declaration within Its Block**

The declaration of an identifier or label must precede all corresponding occurrences of that identifier or label in the program text--i.e., identifiers and labels cannot be used until after they are declared.

There is one exception to this rule: The base-type of a pointer-type (see Section 3.3) can be an identifier that has not yet been declared. In this case, the identifier must be declared somewhere in the same type-declaration-part in which the pointer-type occurs. (See Appendix B for some odd cases.)

**2.2.4 Redeclaration within a Block**

An identifier or label cannot be declared more than once in the outer level of a particular block, except for record field identifiers.

A record field identifier (see Sections 3.2.2, 4.3, and 4.3.2) is declared within a record-type. It is meaningful only in combination with a reference to a variable of that record-type. Therefore a field identifier can be declared again within the same block, as long as it is not declared again at the same level within the same record-type. Also, an identifier that has been declared to denote a constant, a type, or a variable can be declared again as a record field identifier in the same block.

### **2.2.5 Identifiers of Standard Objects**

Pascal on the Lisa provides a set of standard (predeclared) constants, types, procedures, and functions. The identifiers of these objects behave as if they were declared in an outermost block enclosing the entire program; thus their scope includes the entire program.

# Chapter 3

## Data Types

3.1	Simple-Types (and Ordinal-Types)	3-2
3.1.1	Standard Simple-Types and String-Types	3-3
3.1.1.1	The Integer Type	3-3
3.1.1.2	The Longint Type	3-3
3.1.1.3	The Real Type	3-4
3.1.1.4	The Boolean Type	3-4
3.1.1.5	The Char Type	3-4
3.1.1.6	String-Types	3-5
3.1.2	Enumerated-Types	3-6
3.1.3	Subrange-Types	3-7
3.2	Structured-Types	3-7
3.2.1	Array-Types	3-8
3.2.2	Record-Types	3-9
3.2.3	Set-Types	3-11
3.2.4	File-Types	3-12
3.3	Pointer-Types	3-13
3.4	Identical and Compatible Types	3-13
3.4.1	Type Identity	3-14
3.4.2	Compatibility of Types	3-15
3.4.3	Assignment-Compatibility	3-15
3.5	The Type-Declaration-Part	3-16





# Data Types

A *type* is used in declaring variables; it determines the set of values which those variables can assume, and the operations that can be performed upon them. A *type-declaration* associates an identifier with a type.

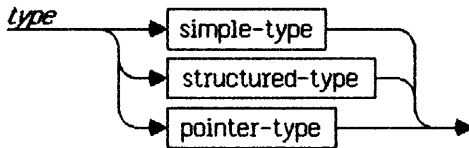

The occurrence of an identifier on the left-hand side of a type-declaration declares it as a type-identifier for the block in which the type-declaration occurs. The scope of a type-identifier does not include its own declaration, except for pointer-types (see Sections 2.2.3 and 3.3).

To help clarify the syntax description with some semantic hints, the following terms are used to distinguish identifiers according to what they denote. Syntactically, all of them mean simply an identifier:

- simple-type-identifier
- structured-type-identifier
- pointer-type-identifier
- ordinal-type-identifier
- real-type-identifier
- string-type-identifier

In other words, a simple-type-identifier is any identifier that is declared to denote a simple type, a structured-type-identifier is any identifier that is declared to denote a structured type, and so forth. A simple-type-identifier can be the predeclared identifier of a standard type such as *integer*, *boolean*, etc.

### 3.1 Simple-Types (and Ordinal-Types)

All the simple-types define ordered sets of values.

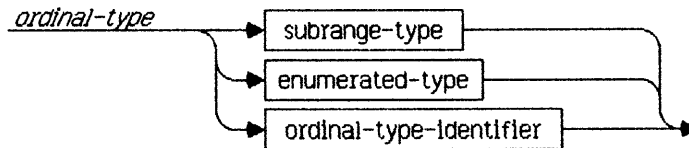
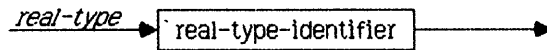
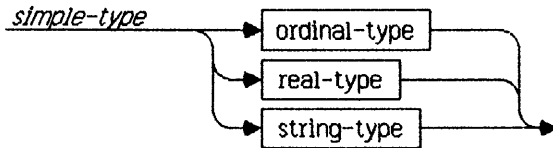

The standard real-type-identifier is **real**.

String-types are discussed in Section 3.1.1.6 below.

*Ordinal-types* are a subset of the simple-types, with the following special characteristics:

- Within a given ordinal-type, the possible values are an ordered set and each possible value is associated with an *ordinality*, which is an **integer** value. The first value of the ordinal-type has ordinality 0, the next has ordinality 1, etc. Each possible value except the first has a *predecessor* based on this ordering, and each possible value except the last has a *successor* based on this ordering.
- The standard function **ord** (see Section 11.5.1) can be applied to any value of ordinal-type, and returns the ordinality of the value.
- The standard function **pred** (see Section 11.5.4) can be applied to any value of ordinal-type, and returns the predecessor of the value. (For the first value in the ordinal-type, the result is unspecified.)
- The standard function **succ** (see Section 11.5.3) can be applied to any value of ordinal-type, and returns the successor of the value. (For the first value in the ordinal-type, the result is unspecified.)

All simple-types except *real* and the string-types are ordinal-types. The standard ordinal-type-identifiers are:

**integer**  
**longint**  
**char**  
**boolean**

Note that in addition to these standard types, the enumerated-types and subrange-types are ordinal-types.

### 3.1.1 Standard Simple-Types and String-Types

A standard type is denoted by a predefined type-identifier. The simple-types **integer**, **longint**, **real**, **char**, and **boolean** are standard. The string-types are *user-defined* simple-types.

#### 3.1.1.1 The Integer Type

The values are a subset of the whole numbers. (As constants, these values can be denoted as specified in Section 1.4.) The predefined **integer** constant **maxint** is defined to be 32767. **Maxint** defines the range of the type **integer** as the set of values:

**-maxint-1, -maxint, ... -1, 0, 1, ... maxint-1, maxint**

These are 16-bit, 2's-complement integers.

#### 3.1.1.2 The Longint Type

The values are a subset of the whole numbers. (As constants, these values can be denoted as specified in Section 1.4.) The range is the set of values from  $-(2^{31}-1)$  to  $2^{31}-1$ , i.e., -2147483648 to 2147483647.

These are 32-bit integers.

Arithmetic on **integer** and **longint** operands is done in both 16-bit and 32-bit precision. An expression with mixed operand sizes is evaluated in a manner similar to the FORTRAN single/double precision floating-point arithmetic rules:

- All "integer" constants in the range of type **integer** are considered to be of type **integer**. All "integer" constants in the range of type **longint**, but not in the range of type **integer**, are considered to be of type **longint**.
- When both operands of an operator (or the single operand of a unary operator) are of type **integer**, 16-bit operations are always performed and the result is of type **integer** (truncated to 16 bits if necessary).
- When one or both operands are of type **longint**, all operands are first converted to type **longint**, 32-bit operations are performed, and the result is of type **longint**. However, if this value is assigned to a variable of type **integer**, it is truncated (see next rule).

- The expression on the right of an assignment statement is evaluated *independently of the size of the variable on the left*. If necessary, the result of the expression is truncated or extended to match the size of the variable on the left.

The `ord` function (see Section 11.3.3) can be used to convert an `integer` value to a `longint` value.

---

#### IMPLEMENTATION NOTE

---

There is a performance penalty for the use of `longint` values. The penalty is essentially a factor of 2 for operations other than division and multiplication; for division and multiplication, the penalty is much worse than a factor of 2.

---

### 3.1.1.3 The Real Type

For details of IEEE standard floating-point arithmetic, see Appendix D. The possible `real` values are

- Finite values (a subset of the mathematical real numbers). As constants, these values can be denoted as specified in Section 1.4.

The largest absolute numeric `real` value is approximately 3.402823466E38 in Pascal notation.

The smallest absolute numeric non-zero `real` value is approximately 1.401298464E-45 in Pascal notation.

The `real` zero value has a sign, like other numbers. However, the sign of a zero value is disregarded except in division of a finite number by zero and in textual output.

- Infinite values,  $+\infty$  and  $-\infty$ . These arise either as the result of an operation that overflows the maximum absolute finite value, or as the result of dividing a finite value by zero. Appendix D gives the rules for arithmetic operations using these values.
- NaNs (the word "NaN" stands for "Not a Number"). These are values of type `real` that convey diagnostic information. For example, the result of multiplying  $\infty$  by 0 is a NaN.

### 3.1.1.4 The Boolean Type

The values are truth values denoted by the predefined constant identifiers `false` and `true`. These values are ordered so that `false` is "less than" `true`. The function-call `ord(false)` returns 0, and `ord(true)` returns 1 (see Section 11.5.1).

### 3.1.1.5 The Char Type

The values are extended 8-bit ASCII, represented by numeric codes in the range 0..255. The ordering of the `char` values is defined by the ordering of these numeric codes. The function-call `ord(c)`, where `c` is a `char` value, returns the numeric code of `c` (see Section 11.5.1).

### 3.1.1.6 String-Types

A string value is a sequence of characters that has a dynamic *length* attribute. The length is the actual number of characters in the sequence at any time during program execution.

A string type has a static *size* attribute. The size is the maximum limit on the length of any value of this type. The current value of the length attribute is returned by the standard function `length` (see Section 11.6); the size attribute of a string type is determined when the string type is defined.

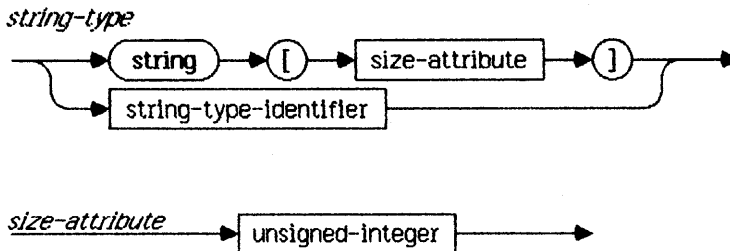

where the size attribute is an unsigned-integer.

---

#### IMPLEMENTATION NOTE

---

In the current implementation, the size-attribute must be in the range from 1 to 255.

---

The ordering relationship between any two string values is determined by lexical comparison based on the ordering relationship between character values in corresponding positions in the two strings. (When the two strings are of unequal lengths, each character in the longer string that does not correspond to a character in the shorter one compares "higher"; thus the string 'attribute' is ordered higher than 'at'.)

Do not confuse the size with the length.

## NOTES

The size attribute of a string *constant* is equal to the length of the string constant value, namely the number of characters actually in the string.

Although string-types are simple-types by definition, they have some characteristics of structured-types. As explained in Section 4.3.1, individual characters in a string can be accessed as if they were components of an array. Also, all string-types are implicitly packed types and all restrictions on packed types apply to strings (see Sections 7.3.2, 5.1.6.1, and 11.7).

Do not make any assumptions about the internal storage format of strings, as this format may not be the same in all implementations.

Operators applicable to strings are specified in Section 5.1.5. Standard procedures and functions for manipulating strings are described in Section 11.6.

### 3.1.2 Enumerated-Types

An enumerated-type defines an ordered set of values by listing the identifiers that denote these values. The ordering of these values is determined by the sequence in which the identifiers are listed.

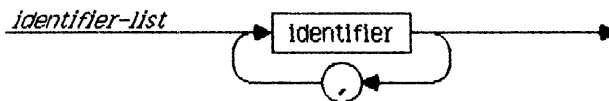
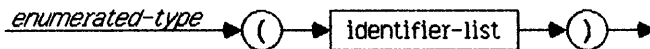

The occurrence of an identifier within the identifier-list of an enumerated-type declares it as a constant for the block in which the enumerated-type is declared. The type of this constant is the enumerated-type being declared.

*Examples of enumerated-types:*

```

color = (red, yellow, green, blue)
suit = (club, diamond, heart, spade)
maritalStatus = (married, divorced, widowed, single)

```

Given these declarations, **yellow** is a constant of type **color**, **diamond** is a constant of type **suit**, and so forth.

When the **ord** function (see Section 11.5.1) is applied to a value of an enumerated-type, it returns an integer representing the ordering of the value

with respect to the other values of the enumerated-type. For example, given the declarations above, `ord(red)` returns 0, `ord(yellow)` returns 1, and `ord(blue)` returns 3.

### 3.1.3 Subrange-Types

A subrange-type provides for range-checking of values within some ordinal-type. The syntax for a subrange-type is



Both constants must be of ordinal-type. Both constants must either be of the same ordinal-type, or one must be of type `integer` and the other of type `longint`. If both are of the same ordinal-type, this type is called the *host-type*. If one is of type `integer` and the other of type `longint`, the host-type is `longint`. Note that no range-checking is done if the host-type is `longint`.

*Examples of subrange-types:*

```

1..100
-10..+10
red..green

```

A variable of subrange-type possesses all the properties of variables of the host type, with the restriction that its run-time value must be in the specified closed interval.

---

#### IMPLEMENTATION NOTE

---

Range-checking is enabled and disabled by the compiler commands `$R+` and `$R-` (see Chapter 12). The default is `$R+` (range-checking enabled).

---

## 3.2 Structured-Types

A structured-type is characterized by its structuring method and by the type(s) of its components. If the component type is itself structured, the resulting structured-type exhibits more than one level of structuring. There is no specified limit on the number of levels to which data-types can be structured.

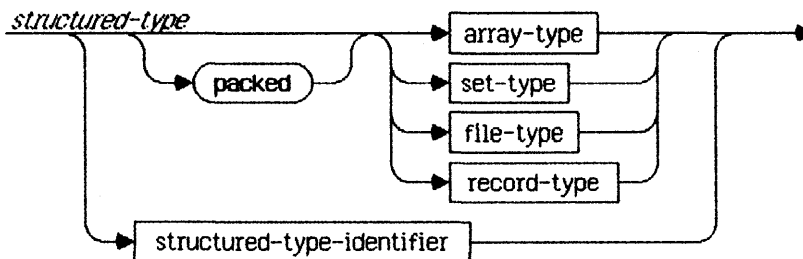



The use of the word **packed** in the declaration of a structured-type indicates to the compiler that data storage should be economized, even if this causes an access to a component of a variable of this type to be less efficient.

The word **packed** only affects the representation of one level of the structured-type in which it occurs. If a component is itself structured, the component's representation is packed only if the word **packed** also occurs in the declaration of its type.

For restrictions on the use of components of packed variables, see Sections 7.3.2, 5.1.6.1, and 11.7.

The implementation of packing is complex, and details of the allocation of storage to components of a packed variable are *unspecified*.

---

#### IMPLEMENTATION NOTE

---

In the current implementation, the word **packed** has no effect on types other than **array** and **record**.

---

### 3.2.1 Array-Types

An array-type consists of a fixed number of components that are all of one type, called the *component-type*. The number of elements is determined by one or more *index-types*, one for each dimension of the array. There is no specified limit on the number of dimensions. In each dimension, the array can be indexed by every possible value of the corresponding index-type, so the number of elements is the product of the cardinalities of all the index-types.

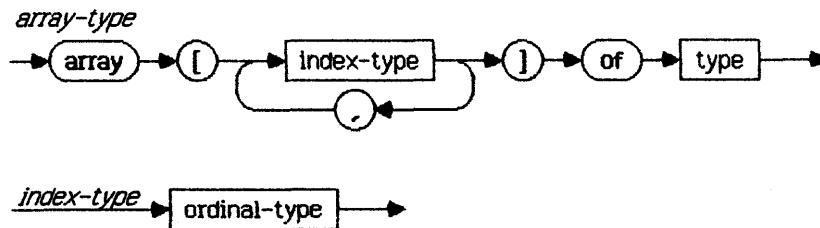

The type following the word **of** is the component-type of the array.

---

#### IMPLEMENTATION NOTE

---

In the current implementation, the index-type should not be **longint** or a subrange of **longint**, and arrays should not contain more than 32767 bytes.

---

*Examples of array-types:*

**array[1..100] of real**  
**array[boolean] of color**

If the component-type of an array-type is also an array-type, the result can be regarded as a single multi-dimensional array. The declaration of such an array is equivalent to the declaration of a multi-dimensional array, as illustrated by the following examples:

**array[boolean] of array[1..10] of array[size] of real**

is equivalent to:

**array[boolean, 1..10, size] of real**

Likewise,

**packed array[1..10] of packed array[1..8] of boolean**

is equivalent to:

**packed array[1..10, 1..8] of boolean**

"Equivalent" means that the compiler does the same thing with the two constructions.

A component of an array can be accessed by referencing the array and applying one or more indexes (see Section 4.3.1).

### 3.2.2 Record-Types

A record-type consists of a fixed number of components called *fields*, possibly of different types. For each component, the record-type declaration specifies the type of the field and an identifier that denotes it.

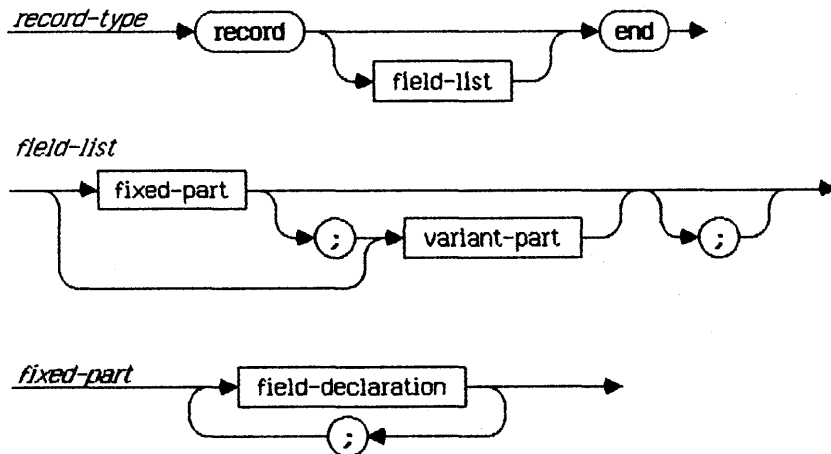

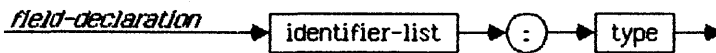

The fixed-part of a record-type specifies a list of "fixed" fields, giving an identifier and a type for each field. Each of these fields contains data that is always accessed in the same way (see Section 4.3.2).

*Example of a record-type:*

```

record
  year: integer;
  month: 1..12;
  day: 1..31
end
    
```

A variant-part allocates memory space with more than one list of fields, thus permitting the data in this space to be accessed in more than one way. Each list of fields is called a *variant*. The variants "overlay" each other in memory, and all fields of all variants are accessible at all times.

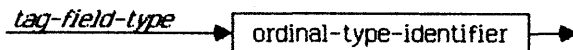
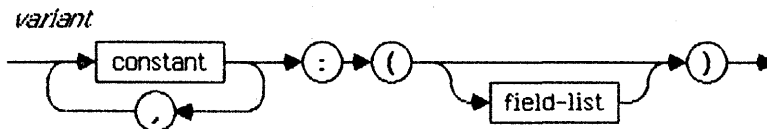
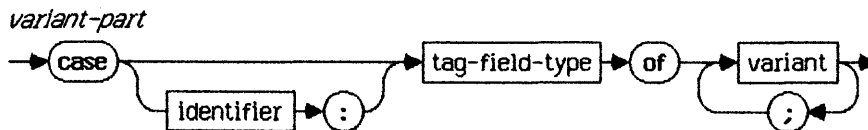

---

**IMPLEMENTATION NOTE**

In the current implementation, the type `longint` should not be used as a tag-type as it will not work correctly.

---

Each variant is introduced by one or more constants. All the constants must be distinct and must be of an ordinal-type that is compatible with the tag-type (see Section 3.4).

The variant-part allows for an optional identifier, called the *tag-field identifier*. If a tag-field identifier is present, it is automatically declared as the identifier of an additional fixed field of the record, called the *tag-field*.

The value of the tag-field may be used by the program to indicate which variant should be used at a given time. If there is no tag-field, then the program must select a variant on some other criterion.

*Examples of record-types with variants:*

```

record
  name, firstName: string[80];
  age: 0..99;
  case married: boolean of
    true: (spousesName: string[80]);
    false: ()
end

record
  x, y: real;
  area: real;
  case s: shape of
    triangle: (side: real; inclination, angle1, angle2:
              angle);
    rectangle: (side1, side2 : real; skew, angle3: angle);
    circle: (diameter: real);
end

```

---

#### NOTE

The constants that introduce a variant are not used for referring to fields of the variant; however, they can be used as optional arguments of the `new` procedure (see Section 11.2). Variant fields are accessed in exactly the same way as fixed fields (see Section 4.3.2).

---

### 3.2.3 Set-Types

A set-type defines a range of values that is the powerset of some ordinal-type, called the *base-type*. In other words, each possible value of a set-type is some subset of the possible values of the base-type.



---

**IMPLEMENTATION NOTE**

---

In the present implementation the base-type must not be **longint**. The base-type must not have more than 4088 possible values. If the base-type is a subrange of **integer**, it must be within the limits 0..4087.

---

Operators applicable to sets are specified in Section 5.1.4. Section 5.3 shows how set values are denoted in Pascal.

Sets with less than 32 possible values in the base-type can be held in a register and offer the best performance. For sets larger than this, there is a performance penalty that is essentially a linear function of the size of the base-type.

The empty set (see Section 5.1.4) is a possible value of every set-type.

### 3.2.4 File-Types

A file-type is a structured-type consisting of a sequence of components that are all of one type, the *component-type*. The component-type may be any type.

The component data is not in program-addressable memory but is accessed via a peripheral device. The number of components (i.e. the length of the file) is not fixed by the file-type declaration.

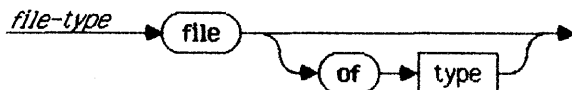

The type **file** (without the "of type" construct) represents a so-called "untyped file" type for use with the **blockread** and **blockwrite** functions (see Section 10.4).

---

**NOTE**

---

Although the symbol **file** can be used as if it were a type-identifier, it cannot be redeclared since it is a reserved word.

---

The standard file-type **text** denotes a file of text organized into lines. The file may be stored on a file-structured device, or it may be a stream of characters from a *character device* such as the Lisa keyboard. Files of type **text** are supported by the specialized I/O procedures discussed in Section 10.3.

In Pascal on the Lisa, the type **text** is distinct from the type **file of char** (unlike standard Pascal). The type **file of char** is a file whose records are of

type **char**, containing **char** values that are not interpreted or converted in any way during I/O operations.

In a stored file of type **text** or **file** of  $-128..127$ , the component values are packed into bytes on the storage medium. However, this does not apply to the type **file of char**; the component values of this type are stored in 16-bit words.

In Pascal on the Lisa, files can be passed to procedures and functions as variable parameters, as explained in Section 7.3.2.

Sections 4.3.3, 10.2, 10.3, and 10.4 discuss methods of accessing file components and data.

### 3.3 Pointer-Types

A pointer-type defines an unbounded set of values that point to variables of a specified type called the *base-type*.

Pointer values are created by the standard procedure **new** (see Section 11.2.1), by the  $\bullet$  operator (see Section 5.1.6), and by the standard procedure **pointer** (see Section 11.3.4).

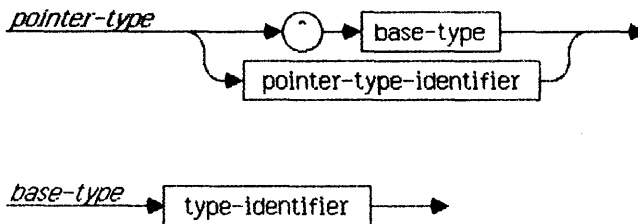

---

#### NOTE

The base-type may be an identifier that has not yet been declared. In this case, it must be declared somewhere in the same block as the pointer-type.

---

The special symbol **nil** represents a standard pointer-valued constant that is a possible value of every pointer type. Conceptually, **nil** is a pointer that does not point to anything.

Section 4.3.4 discusses the syntax for referencing the object pointed to by a pointer variable.

### 3.4 Identical and Compatible Types

As explained below, this Pascal has stronger typing than standard Pascal. In Pascal on the Lisa, two types may or may not be *identical*, and identity is required in some contexts but not in others.

Even if not identical, two types may still be *compatible*, and this is sufficient in contexts where identity is not required—except for assignment, where *assignment-compatibility* is required.

### 3.4.1 Type Identity

Identical types are required *only* in the following contexts:

- Variable parameters (see Section 7.3.2).
- Result types of functional parameters (see Section 7.3.4).
- Value and variable parameters within parameter-lists of procedural or functional parameters (see Section 7.3.5).
- One-dimensional **packed arrays of char** being compared via a relational operator (see Section 5.1.5).

Two types, *t1* and *t2*, are *identical* if either of the following is true:

- The same *type identifier* is used to declare both *t1* and *t2*, as in

```
foo = ^integer;
t1 = foo;
t2 = foo;
```

- *t1* is declared to be equivalent to *t2* as in

```
t1 = t2;
```

Note that the declarations

```
t1 = t2;
t3 = t1;
```

*do not* make *t3* and *t2* identical, even though they make *t1* identical to *t2* and *t3* identical to *t1*!

Also note that the declarations

```
t4 = integer;
t5 = integer;
```

*do* make *t4* and *t5* identical, since both are defined by the same type identifier. In general, the declarations

```
t6 = t7;
t8 = t7;
```

*do* make *t6* and *t8* identical if *t7* is a type-identifier.

However, the declarations

```
t9 = ^integer;
t10 = ^integer;
```

*do not* make *t9* and *t10* identical since *^integer* is not a type identifier but a user-defined type consisting of the special symbol *^* and a type identifier.

Finally, note that two variables declared in the same declaration, as in

```
var1, var2: ^integer;
```

are of identical type. However, if the declarations are separate then the definitions above apply.

The declarations

```
var1: ^integer;
var2: ^integer;
var3: integer;
var4: integer;
```

make **var3** and **var4** identical in type, but not **var1** and **var2**.

### 3.4.2 Compatibility of Types

Compatibility is required in the majority of contexts where two or more entities are used together, e.g. in expressions. Specific instances where type compatibility is required are noted elsewhere in this manual.

Two types are *compatible* if any of the following are true:

- They are identical.
- One is a subrange of the other.
- Both are subranges of the same type.
- Both are string-types (the lengths and sizes may differ).
- Both are set-types, and their base-types are compatible.

### 3.4.3 Assignment-Compatibility

Assignment-compatibility is required whenever a value is assigned to something, either explicitly (as in an assignment-statement) or implicitly (as in passing value parameters).

The value of an expression **expval** of type **exptyp** is assignment-compatible with a variable, parameter, or function-identifier of type **vtyp** if any of the following is true.

- **vtyp** and **exptyp** are identical and neither is a file-type, or a structured-type with a file component.
- **vtyp** is **real** and **exptyp** is **integer** or **longint** (**expval** is coerced to type **real**).
- **vtyp** and **exptyp** are compatible ordinal-types, and **expval** is within the range of possible values of **vtyp**.
- **vtyp** and **exptyp** are compatible set-types, and all the members of **expval** are within the range of possible values of the base-type of **vtyp**.
- **vtyp** and **exptyp** are **string** types, and the current length of **expval** is equal to or less than the size-attribute of **vtyp**.



- `vtyp` is a **string** type or a **char** type and `expval` is a quoted-character-constant.
- `vtyp` is a **packed array**[1..*n*] of **char** and `expval` is a string constant containing exactly *n* characters.

If the index-type of the **packed array of char** is not 1..*n*, but the array does have exactly *n* elements, no error will occur. However, the results are unspecified.

Whenever assignment-compatibility is required and none of the above is true, either a compiler error or a run-time error occurs.

### 3.5 The Type-Declaration-Part

Any program, procedure, or function that declares types contains a type-declaration-part, as shown in Chapter 2.

*Example of a type-declaration-part:*

```

type count = integer;
range = integer;
color = (red, yellow, green, blue);
sex = (male, female);
year = 1900..1999;
shape = (triangle, rectangle, circle);
card = array[1..80] of char;
str = string[80];
polar = record r: real; theta: angle end;
person = ^personDetails;
personDetails = record
    name, firstName: str;
    age: integer;
    married: boolean;
    father, child, sibling: person;
    case s: sex of
        male: (enlisted, bearded: boolean);
        female: (pregnant: boolean)
    end;
people = file of personDetails;
intfile = file of integer;

```

In the above example `count`, `range`, and `integer` denote identical types. The type `year` is compatible with, but not identical to, the types `range`, `count`, and `integer`.

# Chapter 4

## Variables

<b>4.1</b>	<b>Variable-Declarations</b> .....	<b>4-1</b>
<b>4.2</b>	<b>Variable-References</b> .....	<b>4-1</b>
<b>4.3</b>	<b>Qualifiers</b> .....	<b>4-2</b>
4.3.1	Arrays, Strings, and Indexes .....	4-2
4.3.2	Records and Field-Designators .....	4-4
4.3.3	File-Buffers .....	4-4
4.3.4	Pointers and Their Objects .....	4-4



# Variables

## 4.1 Variable-Declarations

A variable-declaration consists of a list of identifiers denoting new variables, followed by their type.

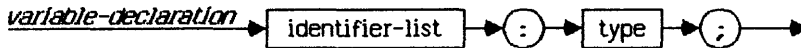

The occurrence of an identifier within the identifier-list of a variable-declaration declares it as a variable-identifier for the block in which the declaration occurs. The variable can then be referenced throughout the remaining lexical extent of that block, except as specified in Section 2.2.2.

*Examples of variable-declarations:*

```
x, y, z: real;  
i, j: integer;  
k: 0..9;  
p, q, r: boolean;  
operator: (plus, minus, times);  
a: array[0..63] of real;  
c: color;  
f: file of char;  
hue1, hue2: set of color;  
p1, p2: person;  
m, m1, m2: array[1..10, 1..10] of real;  
coord: polar;  
pooltape: array[1..4] of tape;
```

## 4.2 Variable-References

A variable-reference denotes the value of a variable of simple-type or pointer-type, or the collection of values represented by a variable of structured-type.

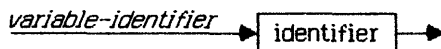
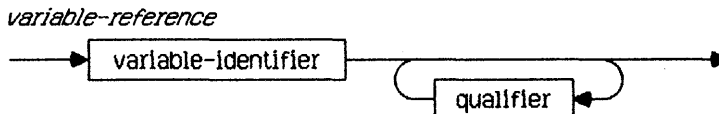

Syntax for the various kinds of qualifiers is given below.

### 4.3 Qualifiers

As shown above, a variable-reference is a variable-identifier followed by zero or more *qualifiers*. Each qualifier modifies the meaning of the variable-reference.

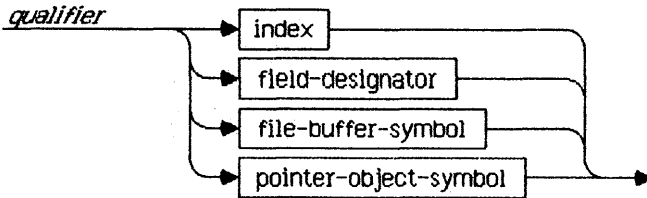

An array identifier with no qualifier is a reference to the entire array:

**xResults**

If the array identifier is followed by an index, this denotes a specific component of the array:

**xResults[current+1]**

If the array component is a record, the index may be followed by a field-designator; in this case the variable-reference denotes a specific field within a specific array component.

**xResults[current+1].link**

If the field is a pointer, the field-designator may be followed by the pointer-object-symbol, to denote the object pointed to by the pointer:

**xResults[current+1].link^**

If the object of the pointer is an array, another index can be added to denote a component of this array (and so forth):

**xResults[current+1].link^[1]**

#### 4.3.1 Arrays, Strings, and Indexes

A specific component of an array variable is denoted by a variable-reference that refers to the array variable, followed by an index that specifies the component.

A specific character within a string variable is denoted by a variable-reference that refers to the string variable, followed by an index that specifies the character position.

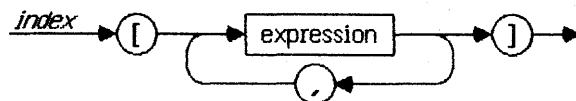

*Examples of Indexed arrays:*

```
m[1, j]
a[1+j]
```

Each expression in the index selects a component in the corresponding dimension of the array. The number of expressions must not exceed the number of index-types in the array declaration, and the type of each expression must be assignment-compatible with the corresponding index-type.

In indexing a multi-dimensional array, you can use either multiple indexes or multiple expressions within an index. The two forms are completely equivalent. For example,

```
m[1][j]
```

is equivalent to

```
m[1, j]
```

For array variables, each index expression must be *assignment-compatible* with the corresponding index-type specified in the declaration of the array-type.

A string value can be indexed by only one index expression, whose value must be in the range 1..*n*, where *n* is the current length of the string value. The effect is to access one character of the string value.

---

#### WARNING

---

When a string value is manipulated by assigning values to individual character positions, the dynamic length of the string is not maintained. For example, suppose that `strval` is declared as follows:

```
strval: string[10];
```

The memory space allocated for `strval` includes space for 10 `char` values and a number that will represent the current length of the string--i.e., the number of `char` values currently in the string. Initially, all of this space contains unspecified values. The assignment

```
strval[1]:= 'F'
```

may or may not work, depending on what the unspecified length happens to be. If this assignment works, it stores the `char` value 'F' in character position 1, but the length of `strval` remains unspecified. In other words, the value of `strval[1]` is now 'F', but the value of `strval` is unspecified. Therefore, the effect of a statement such as `writeln(strval)` is unspecified.

Therefore, this kind of string manipulation is not recommended. Instead, use the standard procedures described in Section 11.6. These procedures properly maintain the lengths of the string values they modify.

---

**4.3.2 Records and Field-Designators**

A specific field of a record variable is denoted by a variable-reference that refers to the record variable, followed by a field-designator that specifies the field.



Examples of field-designators:

p2<sup>^</sup>.pregnant  
coord.theta

**4.3.3 File-Buffers**

Although a file variable may have any number of components, only one component is accessible at any time. The position of the current component in the file is called the *current file position*. See Sections 10.2 and 10.3 for standard procedures that move the current file position. Program access to the current component is via a special variable associated with the file, called a *file-buffer*.

The file-buffer is implicitly declared when the file variable is declared. If F is a file variable with components of type T, the associated file-buffer is a variable of type T.

The file-buffer associated with a file variable is denoted by a variable-reference that refers to the file variable, followed by a qualifier called the file-buffer-symbol.

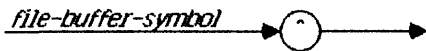

Thus the file-buffer of file F is referenced by F<sup>^</sup>.

Sections 10.2 and 10.3 describe standard procedures that are used to move the current file position within the file and to transfer data between the file-buffer and the current file component.

**4.3.4 Pointers and Their Objects**

The value of a pointer variable is either *nil*, or a value that identifies some other variable, called the *object of the pointer*.

The object pointed to by a pointer variable is denoted by a variable-reference that refers to the pointer variable, followed by a qualifier called the pointer-object-symbol.



---

**NOTE**

---

Pointer values are created by the standard procedure **new** (see Section 11.2.1), by the **^** operator (see Section 5.1.6), and by the standard procedure **pointer** (see Section 11.3.4).

---

The constant **nil** (see Section 3.3) does not point to a variable. If you access memory via a **nil** pointer reference, the results are unspecified; there may not be any error indication.

*Examples of references to objects of pointers:*

**p1** ^  
**p1** ^ .**sibling** ^





# Chapter 5

## Expressions

5.1	Operators.....	5-4
5.1.1	Binary Operators: Order of Evaluation of Operands.....	5-4
5.1.2	Arithmetic Operators.....	5-4
5.1.3	Boolean Operators.....	5-6
5.1.4	Set Operators.....	5-6
5.1.4.1	Result Type in Set Operations.....	5-7
5.1.5	Relational Operators.....	5-7
5.1.5.1	Comparing Numbers.....	5-7
5.1.5.2	Comparing Booleans.....	5-8
5.1.5.3	Comparing Strings.....	5-8
5.1.5.4	Comparing Sets.....	5-8
5.1.5.5	Testing Set Membership.....	5-8
5.1.5.6	Comparing Packed Arrays of Char.....	5-8
5.1.6	@-Operator.....	5-8
5.1.6.1	@-Operator with a Variable.....	5-9
5.1.6.2	@-Operator with a Value Parameter.....	5-9
5.1.6.3	@-Operator with a Variable Parameter.....	5-9
5.1.6.4	@-Operator with a Procedure or Function.....	5-9
5.2	Function-Calls.....	5-10
5.3	Set-Constructors.....	5-11



# Expressions

Expressions consist of operators and operands, i.e. variables, constants, set-constructors, and function calls. Table 5-1 shows the operator precedence:

Table 5-1  
Precedence of Operators

<i>Operators</i>	<i>Precedence</i>	<i>Categories</i>
⊙, not	highest	unary operators
*, /, div, mod, and	second	"multiplying" operators
+, -, or	third	"adding" operators & signs
=, <>, <, >, <=, >=, in	lowest	relational operators

The following rules specify the way in which operands are bound to operators:

- When an operand is written between two operators of different precedence, it is bound to the operator with the higher precedence.
- When an operand is written between two operators of the same precedence, it is bound to the operator on the left.

Note that the order in which operations are performed is not specified.

These rules are implicit in the syntax for expressions, which are built up from factors, terms, and simple-expressions.

The syntax for a *factor* allows the unary operators ⊙ and not to be applied to a value:

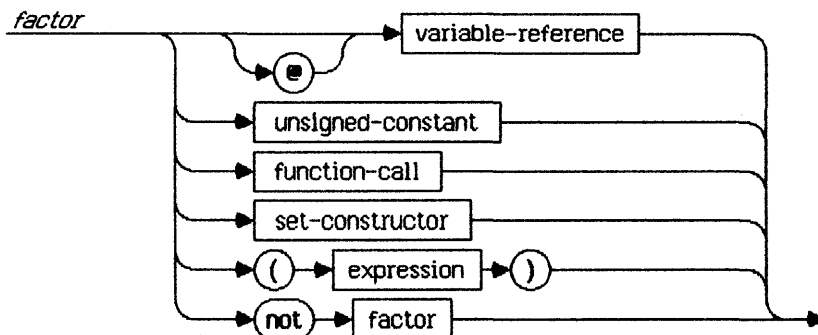

A *function-call* activates a function, and denotes the value returned by the function (see Section 5.2). A *set-constructor* denotes a value of a set-type (see Section 5.3). An *unsigned-constant* has the following syntax:

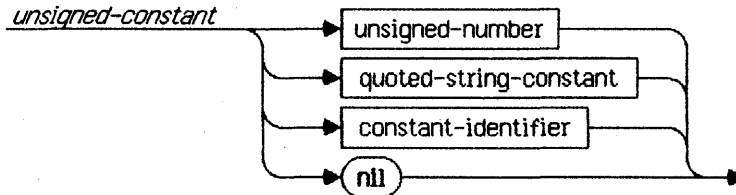

Examples of factors:

x	{variable-reference}
@x	{pointer to a variable}
15	{unsigned-constant}
(x+y+z)	{sub-expression}
sin(x/2)	{function-call}
['A'..'F', 'a'..'f']	{set-constructor}
not p	{negation of a boolean}

The syntax for a *term* allows the "multiplying" operators to be applied to factors:

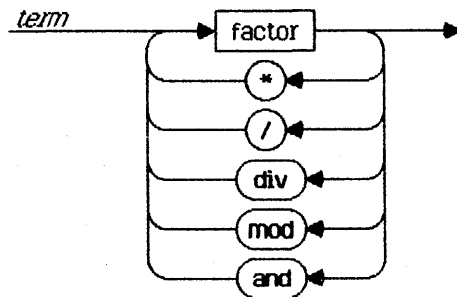

Examples of terms:

```

x*y
1/(1-1)
p and q
(x <= y) and (y < z)

```

The syntax for a *simple-expression* allows the "adding" operators and signs to be applied to terms:

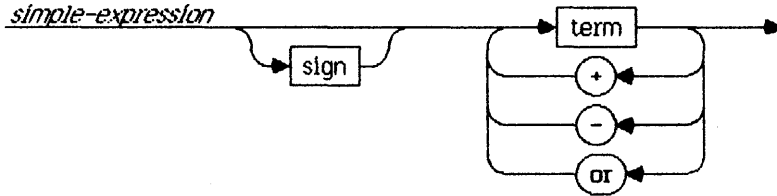

Examples of *simple-expressions*:

$x+y$   
 $-x$   
 $hue1 + hue2$   
 $i*j + 1$

The syntax for an *expression* allows the relational operators to be applied to *simple-expressions*:

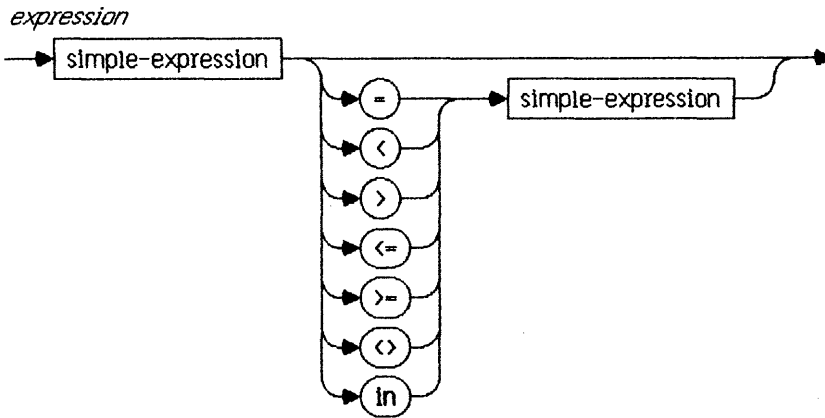

Examples of *expressions*:

$x = 1.5$   
 $p <= q$   
 $p = q$  and  $r$   
 $(i < j) = (j < k)$   
 $c$  in  $hue1$

## 5.1 Operators

### 5.1.1 Binary Operators: Order of Evaluation of Operands

The order of evaluation of the operands of a binary operator is unspecified.

### 5.1.2 Arithmetic Operators

The types of operands and results for arithmetic binary and unary operations are shown in Tables 5-2 and 5-3 respectively.

Table 5-2  
Binary Arithmetic Operations

<i>Operator</i>	<i>Operation</i>	<i>Operand Types</i>	<i>Type of Result</i>
+	addition	integer, real, or longint	integer, real, or longint
-	subtraction		
*	multiplication		
/	division	integer, real, or longint	real
div	division with integer result	integer or longint	integer or longint
mod	modulo	integer or longint	integer
<i>Note:</i> The symbols +, -, and * are also used as set operators (see Section 5.1.4).			

Table 5-3  
Unary Arithmetic Operations (Signs)

<i>Operator</i>	<i>Operation</i>	<i>Operand Types</i>	<i>Type of Result</i>
+	identity	integer, real, or longint	same as operand
-	sign-negation		

Any operand whose type is *subr*, where *subr* is a subrange of some ordinal-type *ordtyp*, is treated as if it were of type *ordtyp*. Consequently an expression that consists of a single operand of type *subr* is itself of type *ordtyp*.

If both the operands of the addition, subtraction, or multiplication operators are of type **integer** or **longint**, the result is of type **integer** or **longint** as described in Section 3.1.1.2; otherwise, the result is of type **real**.

---

**NOTE**

---

See Appendix D for more information on all arithmetic operations with operands or results of type **real**.

---

The result of the identity or sign-negation operator is of the same type as the operand.

The value of **i div j** is the mathematical quotient of  $i/j$ , rounded toward zero to an **integer** or **longint** value. An error occurs if **j=0**.

The value of **i mod j** is equal to the value of

$$i - (i \text{ div } j) * j$$

The sign of the result of **mod** is always the same as the sign of **i**. An error occurs if **j=0**.

The predefined constant **maxint** is of type **integer**. Its value is 32767. This value satisfies the following conditions:

- All whole numbers in the closed interval from **-maxint-1** to **+maxint** are representable in the type **integer**.
- Any unary operation performed on a whole number in this interval will be correctly performed according to the mathematical rules for whole-number arithmetic.
- Any binary integer operation on two whole numbers in this same interval will be correctly performed according to the mathematical rules for whole-number arithmetic, provided that the result is also in this interval. If the mathematical result is not in this interval, then the actual result is the low-order 16 bits of the mathematical result.
- Any relational operation on two whole numbers in this same interval will be correctly performed according to the mathematical rules for whole-number arithmetic.



### 5.1.3 Boolean Operators

The types of operands and results for Boolean operations are shown in Table 5-4.

Table 5-4  
Boolean Operations

<i>Operator</i>	<i>Operation</i>	<i>Operand Types</i>	<i>Type of Result</i>
or	disjunction	boolean	boolean
and	conjunction		
not	negation		

Whether a Boolean expression is completely or partially evaluated if its value can be determined by partial evaluation is unspecified. For example, consider the expression

`true or boolTst(x)`

where `boolTst` is a function that returns a `boolean` value. This expression will always have the value `true`, regardless of the result of `boolTst(x)`. The language definition does not specify whether the `boolTst` function is called when this expression is evaluated. This could be important if `boolTst` has side-effects.

### 5.1.4 Set Operators

The types of operands and results for set operations are shown in Table 5-5.

Table 5-5  
Set Operations

<i>Operator</i>	<i>Operation</i>	<i>Operand Types</i>	<i>Type of Result</i>
+	union	compatible set-types	(see 5.1.4.1)
-	difference		
*	intersection		

#### 5.1.4.1 Result Type in Set Operations

The following rules govern the type of the result of a set operation where one (or both) of the operands is a set of *subr*, where *ordtyp* represents any ordinal-type and *subr* represents a subrange of *ordtyp*:

- If *ordtyp* is not the type *integer*, then the type of the result is *set of ordtyp*.
- If *ordtyp* is the type *integer*, then the type of the result is *set of 0..4087* in the current implementation (0..32767 in a future implementation). This rule results from the limitations on set-types (see Section 3.2.3).

#### 5.1.5 Relational Operators

The types of operands and results for relational operations are shown in Table 5-6, and discussed further below.

Table 5-6  
Relational Operations

<i>Operator</i>	<i>Operation</i>	<i>Operand Types</i>	<i>Type of Result</i>
=	equal	compatible set-, simple-, or pointer-types (& see below)	<b>boolean</b>
<>	not equal		
<	less	compatible simple-types (& see below)	
>	greater		
<=	less/equal		
>=	greater/equal		
<=	subset of	compatible set-types	
>=	superset of		
in	member of	<i>left operand:</i> any ordinal-type T <i>right operand:</i> set of T	

##### 5.1.5.1 Comparing Numbers

When the operands of <, >, >=, or <= are numeric, they need not be of compatible type *if* one operand is real and the other is *integer* or *longint*.

---

#### NOTE

---

See Appendix D for more information on relational operations with operands of type *real*.

---

**5.1.5.2 Comparing Booleans**

If *p* and *q* are **boolean** operands, then *p*=*q* denotes their equivalence and *p*<<*q* denotes the implication of *q* by *p* (because **false**<**true**). Similarly, *p*<>*q* denotes logical "exclusive-or."

**5.1.5.3 Comparing Strings**

When the relational operators =, <>, <, >, <=, and > are used to compare strings (see Section 3.1.1.6), they denote lexicographic ordering according to the ordering of the ASCII character set. Note that any two string values can be compared since all string values are compatible.

**5.1.5.4 Comparing Sets**

If *u* and *v* are set operands, then *u*<=*v* denotes the inclusion of *u* in *v*, and *u*>=*v* denotes the inclusion of *v* in *u*.

**5.1.5.5 Testing Set Membership**

The **in** operator yields the value **true** if the value of the ordinal-type operand is a member of the set-type operand; otherwise it yields the value **false**.

**5.1.5.6 Comparing Packed Arrays of Char**

In addition to the operand types shown in the table, the = and <> operators can also be used to compare a **packed array**[*L*:*N*] of **char** with a string *constant* containing exactly *N* characters, or to compare two one-dimensional packed arrays of **char** of *identical* type.

**5.1.6 @-Operator**

A pointer to a variable can be computed with the @-operator. The operand and result types are shown in Table 5-7.

**Table 5-7**  
**Pointer Operation**

<i>Operator</i>	<i>Operation</i>	<i>Operand</i>	<i>Type of Result</i>
@	pointer formation	variable, parameter, procedure, or function	same as <b>nil</b>

@ is a unary operator taking a single variable, parameter, procedure, or function as its operand and computing the value of its pointer. The type of the value is equivalent to the type of **nil**, and consequently can be assigned to any pointer variable.

### 5.1.6.1 **@-Operator With a Variable**

For an ordinary variable (not a parameter), the use of @ is straightforward. For example, if we have the declarations

```
type twochar = packed array[0..1] of char;
var int: integer;
    twocharptr: ^twochar;
```

then the statement

```
twocharptr := @int
```

causes `twocharptr` to point to `int`. Now `twocharptr^` is a reinterpretation of the bit value of `int` as though it were a `packed array[0..1] of char`.

The operand of @ cannot be a component of a packed variable.

### 5.1.6.2 **@-Operator With a Value Parameter**

When @ is applied to a formal value parameter, the result is a pointer to the stack location containing the actual value. Suppose that `foo` is a formal value parameter in a procedure and `fooPtr` is a pointer variable. If the procedure executes the statement

```
fooPtr := @foo
```

then `fooPtr^` is a reference to the value of `foo`. Note that if the actual-parameter is a variable-reference, `fooPtr^` is not a reference to the variable itself; it is a reference to the value taken from the variable and stored on the stack.

### 5.1.6.3 **@-Operator With a Variable Parameter**

When @ is applied to a formal variable parameter, the result is a pointer to the actual-parameter (the pointer is taken from the stack). Suppose that `fum` is a formal variable parameter of a procedure, `fie` is a variable passed to the procedure as the actual-parameter for `fum`, and `fumptr` is a pointer variable.

If the procedure executes the statement

```
fumptr := @fum
```

then `fumptr` is a pointer to `fie`. `fumptr^` is a reference to `fie` itself.

### 5.1.6.4 **@-Operator With a Procedure or Function**

It is possible to apply @ to a procedure or a function, yielding a pointer to the entry-point. Note that Pascal provides no mechanism for using such a pointer. Currently the only use for a procedure pointer is to pass it to an assembly-language routine, which can then JSR to that address.

If the procedure pointed to is in the local segment, @ returns the current address of the procedure's entry point. If the procedure is in some other segment, however, @ returns the address of the jump table entry for the procedure.

In logical memory mapping (see *Workshop User's Guide for the Lisa*), the procedure pointer is always valid.

In physical memory mapping, code swapping may change a local-segment procedure address without warning, and the procedure pointer can become invalid. If the procedure is not in the local segment, the jump-table entry address will remain valid despite swapping because the jump table is not moved.

### 5.2 Function-Calls

A function-call specifies the activation of the function denoted by the function-identifier. If the corresponding function-declaration contains a list of formal-parameters, then the function-call must contain a corresponding list of actual-parameters. Each actual-parameter is substituted for the corresponding formal-parameter. The correspondence is established by the positions of the parameters in the lists of actual and formal parameters respectively. The number of actual-parameters must be equal to the number of formal parameters.

The order of evaluation and binding of the actual-parameters is unspecified.

*function-call*



*actual-parameter-list*

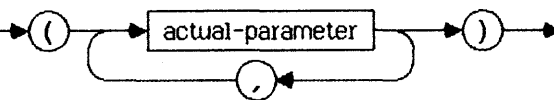

*actual-parameter*

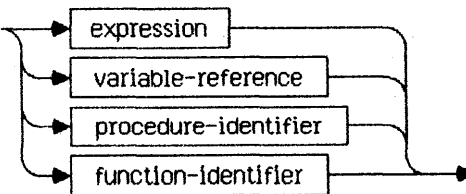

A function-identifier is any identifier that has been declared to denote a function.

Examples of function-calls:

```
sum(a, 63)
gcd(147, k)
sin(x+y)
eof(f)
ord(f^)
```

### 5.3 Set-Constructors

A set-constructor denotes a value of a set-type, and is formed by writing expressions within [brackets]. Each expression denotes a value of the set.

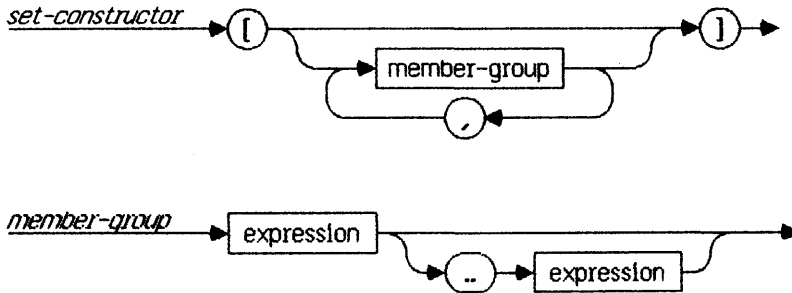

The notation [ ] denotes the empty set, which belongs to every set-type. Any member-group  $x..y$  denotes as set members the range of all values of the base-type in the closed interval  $x$  to  $y$ .

If  $x$  is greater than  $y$ , then  $x..y$  denotes no members and  $[x..y]$  denotes the empty set.

All values designated in member-groups in a particular set-constructor must be of the same ordinal-type. This ordinal-type is the base-type of the resulting set. If an integer value designated as a set member is outside the limits given in Section 3.2.3 (0..4087 in the current implementation), the results are unspecified.

Examples of set-constructors:

```
[red, c, green]
[1, 5, 10..k mod 12, 23]
['A'..'Z', 'a'..'z', chr(xcode)]
```



# Chapter 6

## Statements

<b>6.1</b>	<b>Simple Statements .....</b>	<b>6-1</b>
6.1.1	Assignment-Statements .....	6-1
6.1.2	Procedure-Statements .....	6-2
6.1.3	Goto-Statements .....	6-3
<b>6.2</b>	<b>Structured-Statements .....</b>	<b>6-4</b>
6.2.1	Compound-Statements .....	6-4
6.2.2	Conditional-Statements .....	6-4
6.2.2.1	If-Statements .....	6-5
6.2.2.2	Case-Statements .....	6-5
6.2.3	Repetitive-Statements .....	6-6
6.2.3.1	Repeat-Statements .....	6-7
6.2.3.2	While-Statements .....	6-7
6.2.3.3	For-Statements .....	6-8
6.2.4	With-Statements .....	6-10





# Statements

Statements denote algorithmic actions, and are executable. They can be prefixed by labels; a labeled statement can be referenced by a goto-statement.

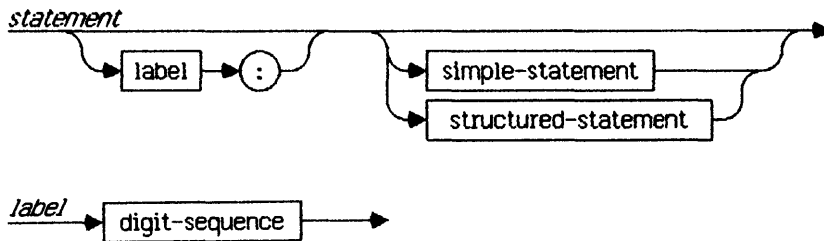

A digit-sequence used as a label must be in the range 0..9999, and must first be declared as described in Section 2.1.

## 6.1 Simple Statements

A simple-statement is a statement that does not contain any other statement.

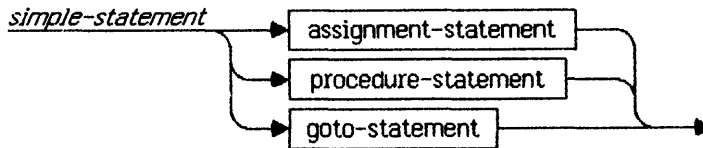

### 6.1.1 Assignment-Statements

The syntax for an assignment-statement is as follows:

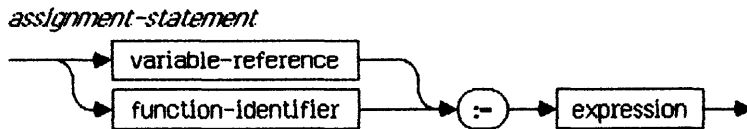

The assignment-statement can be used in two ways:

- To replace the current value of a variable by a new value specified as an expression
- To specify an expression whose value is to be returned by a function.

The expression must be assignment-compatible with the type of the variable or the result-type of the function.

---

**NOTE**

---

If the selection of the variable involves indexing an array or taking the object of a pointer, it is not specified whether these actions precede or follow the evaluation of the expression.

---

*Examples of assignment-statements:*

```
x := y+z;
p := (i<=1) and (i<100);
i := sqrt(k) - (i*j);
hue1 := [blue, succ(c)];
```

### 6.1.2 Procedure-Statements

A procedure-statement serves to execute the procedure denoted by the procedure-identifier.

*procedure-statement*



(A procedure-identifier is simply an identifier that has been used to declare a procedure.)

If the procedure has formal-parameters (see Section 7.3), the procedure-statement must contain a list of actual-parameters that are bound to the corresponding formal-parameters. The number of actual-parameters must be equal to the number of formal parameters. The correspondence is established by the positions of the parameters in the lists of actual and formal parameters respectively.

The rules for an actual-parameter **AP** depend on the corresponding formal-parameter **FP**:

- If **FP** is a value parameter, **AP** must be an expression. The type of the value of **AP** must be assignment-compatible with the type of **FP**.
- If **FP** is a variable parameter, **AP** must be a variable-reference. The type of **AP** must be identical to the type of **FP**.
- If **FP** is a procedural parameter, **AP** must be a procedure-identifier. The type of each formal-parameter of **AP** must be identical to the type of the corresponding formal-parameter of **FP**.

- If FP is a functional parameter, AP must be a function-identifier. The type of each formal-parameter of AP must be identical to the type of the corresponding formal-parameter of FP, and the result-type of AP must be identical to the result-type of FP.

---

**NOTE**

---

The order of evaluation and binding of the actual parameters is unspecified.

---

*Examples of procedure-statements:*

```
printhead;
transpose(a, n, m);
bisection(fct, -1.0, +1.0, x);
```

### 6.1.3 Goto-Statements

A goto-statement causes a jump to another statement in the program, namely the statement prefixed by the label that is referenced in the goto-statement.

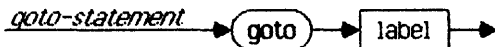

---

**NOTE**

---

The constants that introduce cases within a case-statement (see Section 6.2.2.2) are not labels, and cannot be referenced in goto-statements.

---

The following restrictions apply to goto-statements:

- The effect of a jump into a structured statement from outside of the structured statement is unspecified.
- The effect of a jump between the **then** part and the **else** part of an if-statement is unspecified.
- The effect of a jump between two different cases within a case-statement is unspecified.

### 6.2 Structured-Statements

Structured-statements are constructs composed of other statements that must be executed either conditionally (conditional-statements), repeatedly (repetitive-statements), or in sequence (compound-statement or with-statement).

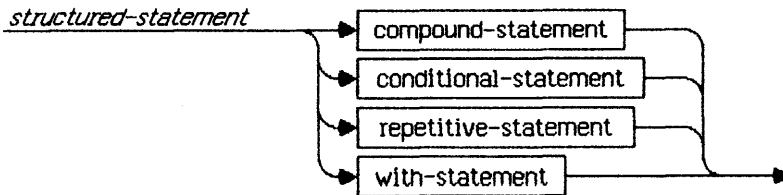

#### 6.2.1 Compound-Statements

The compound-statement specifies that its component statements are to be executed in the same sequence as they are written.

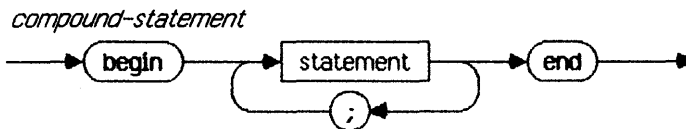

Example of compound-statement:

```

begin
  z := x;
  x := y;
  y := z
end
  
```

An important use of the compound-statement is to group more than one statement into a single statement, in contexts where Pascal syntax only allows one statement. The symbols **begin** and **end** act as "statement brackets." Examples of this will be seen in Section 6.2.3.2.

#### 6.2.2 Conditional-Statements

A conditional-statement selects for execution a single one (or none) of its component statements.

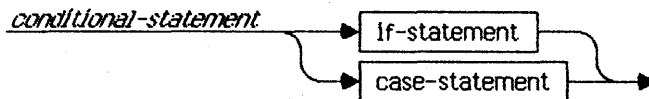

## 6.2.2.1 If-Statements

The syntax for if-statements is as follows:

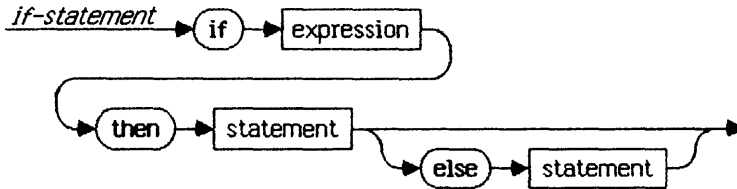

The expression must yield a result of type **boolean**. If the expression yields the value **true**, the statement following the **then** is executed.

If the expression yields **false** and the **else** part is present, the statement following the **else** is executed; if the **else** part is not present, nothing is executed.

The syntactic ambiguity arising from the construct:

```
if e1 then
  if e2 then s1
  else s2
```

is resolved by interpreting the construct as being equivalent to:

```
if e1 then begin
  if e2 then s1
  else s2
end
```

*Examples of if-statements:*

```
if x < 1.5 then z := x+y else z := 1.5;
if p1 <> nil then p1 := p1^.father;
```

## 6.2.2.2 Case-Statements

The case-statement contains an expression (the *selector*) and a list of statements. Each statement must be prefixed with one or more constants (called *case-constant*), or with the reserved word **otherwise**. All the case-constants must be distinct and must be of an ordinal-type that is compatible with the type of the selector.

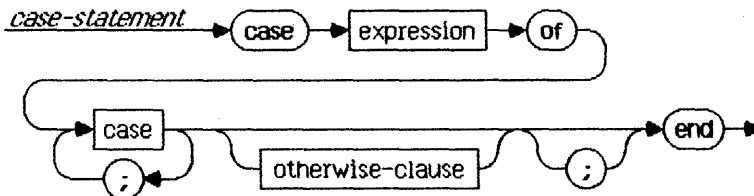

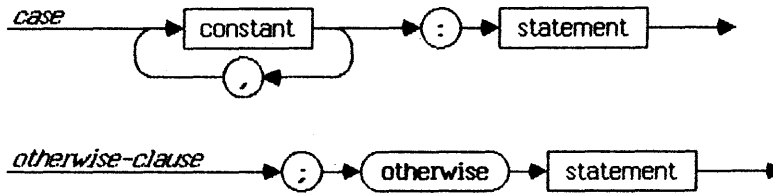

The case-statement specifies execution of the statement prefixed by a case-constant equal to the current value of the selector. If no such case-constant exists and an **otherwise** part is present, the statement following the word **otherwise** is executed; if no **otherwise** part is present, nothing is executed.

*Examples of case-statements:*

```

case operator of
  plus:  x := x+y;
  minus: x := x-y;
  times: x := x*y
end

case 1 of
  1:      x := sin(x);
  2:      x := cos(x);
  3,4,5:  x := exp(x);
  otherwise x := ln(x)
end
    
```

---

**IMPLEMENTATION NOTE**

---

In the current implementation, the case-statement will not work correctly if any case-constant is of type **longint** or the value of the selector is of type **longint**.

---

### 6.2.3 Repetitive-Statements

Repetitive-statements specify that certain statements are to be executed repeatedly.

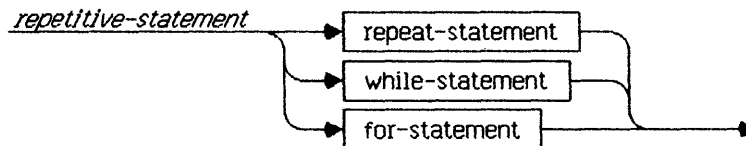

### 6.2.3.1 Repeat-Statements

A repeat-statement contains an expression which controls the repeated execution of a sequence of statements contained within the repeat-statement.

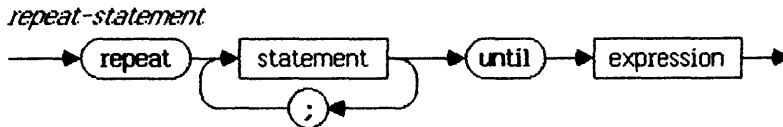

The expression must yield a result of type **boolean**. The statements between the symbols **repeat** and **until** are repeatedly executed until the expression yields the value **true** on completion of the sequence of statements. The sequence of statements is executed at least once, because the expression is evaluated *after* execution of the sequence.

*Examples of repeat-statements:*

```

repeat
  k := i mod j;
  i := j;
  j := k
until j = 0

repeat
  process(f^);
  get(f)
until eof(f)

```

### 6.2.3.2 While-Statements

A while-statement contains an expression which controls the repeated execution of one statement (possibly a compound-statement) contained within the while-statement.

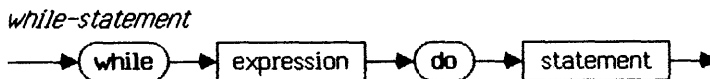

The expression must yield a result of type **boolean**. It is evaluated *before* the contained statement is executed. The contained statement is repeatedly executed as long as the expression yields the value **true**. If the expression yields **false** at the beginning, the statement is not executed.



The while-statement:

```
while b do body
```

is equivalent to:

```
if b then repeat
  body
until not b
```

Examples of while-statements:

```
while a[i] <> x do i := i+1
while i>0 do begin
  if odd(i) then z := z*x;
  i := i div 2;
  x := sqr(x)
end
while not eof(f) do begin
  process(f^);
  get(f)
end
```

### 6.2.3.3 For-Statements

The for-statement causes one contained statement (possibly a compound-statement) to be repeatedly executed while a progression of values is assigned to a variable called the *control-variable*.

*for-statement*

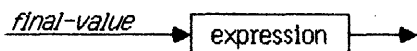
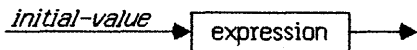
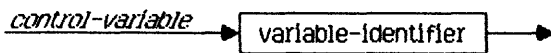
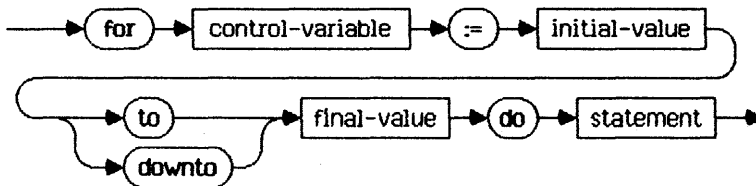

The control-variable must be a variable-identifier (without any qualifier). It must be local to the innermost block containing the for-statement, and must not be a variable parameter of that block. The control-variable must be of ordinal-type, and the initial and final values must be of a type compatible with this type.

The first value assigned to the control-variable is the initial-value.

If the for-statement is constructed with the reserved word **to**, each successive value of the control-variable is the successor (see Section 3.1) of the previous value, using the inherent ordering of values according to the type of the control-variable. When each value is assigned to the control-variable, it is compared to the final-value; if it is less than or equal to the final value, the contained statement is then executed.

If the for-statement is constructed with the reserved word **downto**, each successive value of the control-variable is the predecessor (see Section 3.1) of the previous value. When each value is assigned to the control-variable, it is compared to the final-value; if it is greater than or equal to the final value, the contained statement is then executed.

If the value of the control-variable is altered by execution of the repeated statement, the effect is unspecified. After a for-statement is executed, the value of the control-variable is unspecified, unless the for-statement was exited by a **goto**. Apart from these restrictions, the for-statement:

```
for v := e1 to e2 do body
```

is equivalent to:

```
begin
  temp1 := e1;
  temp2 := e2;
  if temp1 <= temp2 then begin
    v := temp1;
    body;
    while v <> temp2 do begin
      v := succ(v);
      body
    end
  end
end
end
```

and the for-statement:

```
for v := e1 downto e2 do body
```

is equivalent to:

```
begin
  temp1 := e1;
  temp2 := e2;
  if temp1 >= temp2 then begin
    v := temp1;
    body;
    while v <> temp2 do begin
      v := pred(v);
      body
    end
  end
end
```

where `temp1` and `temp2` are auxiliary variables of the host type of the variable `v` that do not occur elsewhere in the program.

*Examples of for-statements:*

```
for i := 2 to 63 do if a[i] > max then max := a[i]
for i := 1 to n do for j := 1 to n do
  begin
    x := 0;
    for k := 1 to n do x := x + m1[i,k]*m2[k,j];
    m[i,j] := x
  end
for c := red to blue do q(c)
```

#### 6.2.4 With-Statements

The syntax for a with-statement is

*with-statement*

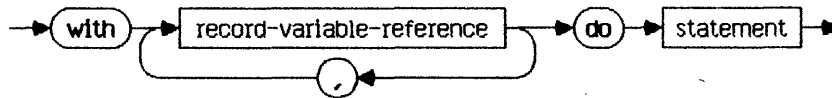

(A record-variable-reference is simply a reference to some record variable.) The occurrence of a record-variable-reference in a with-statement affects the way the compiler processes variable-references within the statement following the word `do`. Fields of the record-variable can be referenced by their field-identifiers, without explicit reference to the record-variable.

*Example of with-statement:*

```
with date do if month = 12 then begin
    month := 1;
    year := year + 1
end
else month := month + 1
```

This is equivalent to:

```
if date.month = 12 then begin
    date.month := 1;
    date.year := date.year + 1
end
else date.month := date.month + 1
```

Within a with-statement, each variable-reference is checked to see if it can be interpreted as a field of the record. Suppose that we have the following declarations:

```
type recTyp = record
    foo: integer;
    bar: real
end;

var baz: recTyp;
    foo: integer;
```

The identifier `foo` can refer both to a field of the record variable `baz` and to a variable of type `integer`. Now consider the statement

```
with baz do begin
    ...
    foo := 36; {which foo is this?}
    ...
end
```

The `foo` in this with-statement is a reference to the field `baz.foo`, not the variable `foo`.

The statement:

```
with v1, v2, ... vn do s
```

is equivalent to the following "nested" with-statements:

```
with v1 do
    with v2 do
        ....
        with vn do s
```

If *vn* in the above statements is a field of both *v1* and *v2*, it is interpreted to mean *v2.vn*, not *v1.vn*. The list of record-variable-references in the with-statement is checked from right to left.

If the selection of a variable in the record-variable-list involves the indexing of an array or the de-referencing of a pointer, these actions are executed before the component statement is executed.

---

**WARNING**

---

If a variable in the record-variable-list is a pointer-reference, the value of the pointer must not be altered within the with-statement. If the value of the pointer is altered, the results are unspecified.

*Example of unsafe with-statement using pointer-reference:*

```
with ppp^ do begin
  ...
  new(ppp); {Don't do this ...}
  ...
  ppp:=xxx; {... or this}
  ...
end
```

---

# Chapter 7

## Procedures and Functions

7.1	Procedure-Declarations .....	7-1
7.2	Function-Declarations .....	7-4
7.3	Parameters .....	7-5
7.3.1	Value Parameters .....	7-7
7.3.2	Variable Parameters .....	7-7
7.3.3	Procedural Parameters .....	7-7
7.3.4	Functional Parameters .....	7-9
7.3.5	Parameter List Compatibility .....	7-9



# Procedures and Functions

## 7.1 Procedure-Declarations

A procedure-declaration associates an identifier with part of a program so that it can be activated by a procedure-statement.

*procedure-declaration*



*procedure-body*

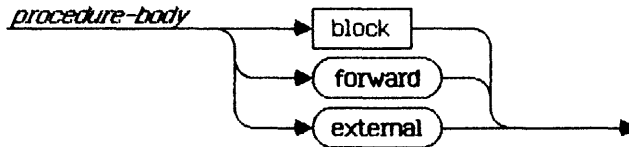

The procedure-heading specifies the identifier for the procedure, and the formal parameters (if any).

*procedure-heading*

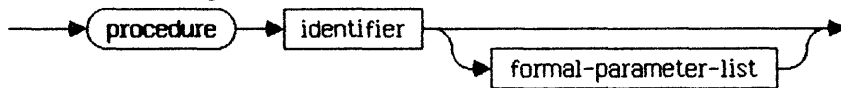

The syntax for a formal-parameter-list is given in Section 7.3.

A procedure is activated by a procedure-statement (see Section 6.1.2), which gives the procedure's identifier and any actual-parameters required by the procedure. The statements to be executed upon activation of the procedure are specified by the statement-part of the procedure's block. If the procedure's identifier is used in a procedure-statement within the procedure's block, the procedure is executed recursively.



*Example of a procedure-declaration:*

```

procedure readInteger (var f: text; var x: integer);
  var value,digitValue: integer;
  begin
    while (f^ = ' ') and not eof(f) do get(f);
    value := 0;
    while (f^ in ['0'..'9']) and not eof(f) do begin
      digitValue := ord(f^) - ord('0');
      value := 10*value + digitValue;
      get(f);
    end;
    x := value
  end;

```

A procedure-declaration that has *forward* instead of a block is called a *forward declaration*. Somewhere after the forward declaration (and in the same block), the procedure is actually defined by a *defining declaration*--a procedure-declaration that uses the same procedure-identifier, omits the formal-parameter-list, and includes a block. The forward declaration and the defining declaration must be local to the same block, but need not be contiguous; that is, other procedures or functions can be declared between them and can call the procedure that has been declared forward. This permits mutual recursion.

The forward declaration and the defining declaration constitute a complete declaration of the procedure. The procedure is considered to be declared at the place of the forward declaration.

*Example of forward declaration:*

```

procedure walter(m,n: integer); {forward declaration}
  forward;

procedure clara(x, y: real);
  begin
    ...
    walter(4, 5); {OK because walter is forward declared}
    ...
  end;

procedure walter; {defining declaration}
  begin
    ...
    clara(8.3, 2.4);
    ...
  end;

```

A procedure-declaration that has *external* instead of a block defines the Pascal interface to a separately assembled or compiled routine (a `.PROC` in the case of assembly language). The external code must be linked with the compiled

Pascal host program before execution; see the *Workshop User's Guide for the Lisa* for details.

*Example of an external procedure-declaration:*

```
procedure makescreen(index: integer);
  external;
```

This means that `makescreen` is an external procedure that will be linked to the host program before execution.

---

#### IMPLEMENTATION NOTE

---

It is the programmer's responsibility to ensure that the external procedure is compatible with the `external` declaration in the Pascal program; the current linker does no checking.

---



---

#### NOTE

---

This Pascal (unlike Apple II and Apple III Pascal) does not allow a variable parameter of an external procedure or function to be declared without a type. To obtain a similar effect, use a formal-parameter of pointer-type, as in the following example:

```
type bigpaoc = packed array[0..32767] of char;
  bigpaoptr = ^bigpaoc;
...
procedure whatever (bytearray: bigpaoptr);
  external;
```

The actual-parameter can be any pointer value obtained via the `@`-operator (see Section 5.1.6). For example, if `dots` is a packed array of `boolean`, it can be passed to `whatever` by writing `whatever(@dots)`

---

This description of external procedures also applies to external functions.

### 7.2 Function-Declarations

A function-declaration serves to define a part of the program that computes and returns a value of simple-type or pointer-type.

*function-declaration*



*function-body*

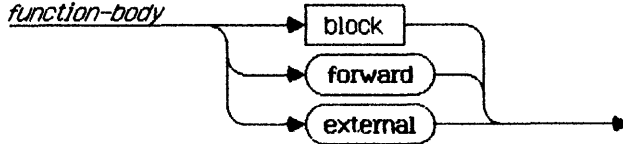

The function-heading specifies the identifier for the function, the formal parameters (if any), and the type of the function result.

*function-heading*

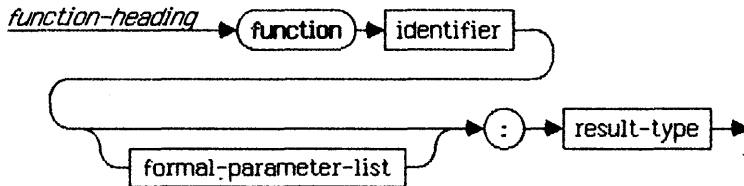

*result-type*

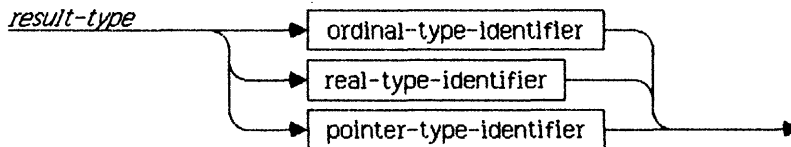

The syntax for a formal-parameter-list is given in Section 7.3.

A function is activated by the evaluation of a function-call (see Section 5.2), which gives the function's identifier and any actual-parameters required by the function. The function-call appears as an operand in an expression. The expression is evaluated by executing the function, and replacing the function-call with the value returned by the function.

The statements to be executed upon activation of the function are specified by the statement-part of the function's block. This block should normally contain at least one assignment-statement (see Section 6.1.1) that assigns a value to the function-identifier. The result of the function is the last value assigned. If no such assignment-statement exists, or if it exists but is not executed, the value returned by the function is unspecified.

If the function's identifier is used in a function-call within the function's block, the function is executed recursively.

*Examples of function-declarations:*

```
function max(a: vector; n: integer): real;
var x: real; i: integer;
begin
  x := a[1];
  for i := 2 to n do if x < a[i] then x := a[i]
max := x
end;

function power(x: real; y: integer): real; { y >= 0 }
var w, z: real; i: integer;
begin
  w := x; z := 1; i := y;
  while i > 0 do begin
    {z*(w**i) = x ** y }
    if odd(i) then z := z*w;
    i := i div 2;
    w := sqr(w)
  end;
  {z = x**y }
  power := z
end;
```

A function can be declared forward in the same manner as a procedure (see Section 7.1 above). This permits mutual recursion.

A function-declaration that has **external** instead of a block defines the Pascal interface to a separately compiled or assembled external routine (a **.FUNC** in the case of assembly language). See the explanation in Section 7.1 above.

### 7.3 Parameters

A formal-parameter-list may be part of a procedure-declaration or function-declaration, or it may be part of the declaration of a procedural or functional parameter.

If it is part of a procedure-declaration or function-declaration, it declares the formal parameters of the procedure or function. Each parameter so declared is local to the procedure or function being declared, and can be referenced by its identifier in the block associated with the procedure or function.

If it is part of the declaration of a procedural or functional parameter, it declares the formal parameters of the procedural or functional parameter. In

this case there is no associated block and the identifiers of parameters in the formal-parameter-list are not significant (see Sections 7.3.3 and 7.3.4 below).

*formal-parameter-list*

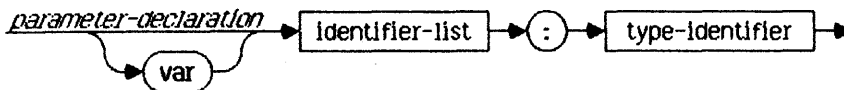
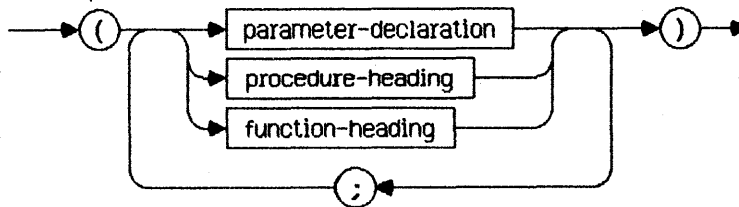

There are four kinds of parameters: *value parameters*, *variable parameters*, *procedural parameters*, and *functional parameters*. They are distinguished as follows:

- A parameter-group preceded by **var** is a list of variable parameters.
- A parameter-group without a preceding **var** is a list of value parameters.
- A procedure-heading or function-heading denotes a procedural or functional parameter; see Sections 7.3.3 and 7.3.4 below.

---

#### NOTE

The types of formal-parameters are denoted by type-identifiers. In other words, only a simple identifier can be used to denote a type in a formal-parameter-list. To use a type such as `array[0..255] of char` as the type of a parameter, you must declare a type-identifier for this type:

```
type charray = array[0..255] of char;
```

The identifier `charray` can then be used in a formal-parameter-list to denote the type.

---

---

**NOTE**

---

The word **file** (for an "untyped" file) is not allowed as a type-identifier in a parameter-declaration, since it is a reserved word. To use a parameter of this type, declare some other identifier for the type **file** --for example,

```
type phyle = file;
```

The identifier **phyle** can then be used in a formal-parameter-list to denote the type **file**.

---

**7.3.1 Value Parameters**

For a value-parameter, the corresponding actual-parameter in a procedure-statement or function-call (see Sections 5.2 and 6.1.2) must be an expression, and its value must not be of file-type or of any structured-type that contains a file-type. The formal value-parameter denotes a variable local to the procedure or function. The current value of the expression is assigned to the formal value-parameter upon activation of the procedure or function. The actual-parameter must be assignment-compatible with the type of the formal value-parameter.

**7.3.2 Variable Parameters**

For a variable-parameter, the corresponding actual-parameter in a procedure-statement or function-call (see Sections 5.2 and 6.1.2) must be a variable-reference. The formal variable-parameter denotes this actual variable during the entire activation of the procedure or function.

Within the procedure or function, any reference to the formal variable-parameter is a reference to the actual-parameter itself. The type of the actual-parameter must be *identical* to that of the formal variable-parameter.

---

**NOTE**

---

If the reference to an actual variable-parameter involves indexing an array or finding the object of a pointer, these actions are executed before the activation of the procedure or function.

---

Components of variables of any packed structured type (including string-types) cannot be used as actual variable parameters.

**7.3.3 Procedural Parameters**

When the formal-parameter is a procedure-heading, the corresponding actual-parameter in a procedure-statement or function-call (see Sections 5.2 and 6.1.2) must be a procedure-identifier. The identifier in the formal procedure-heading represents the actual procedure during execution of the procedure or function receiving the procedural parameter.

*Example of procedural parameters:*

```

program passProc;
  var i: integer;

  procedure a(procedure x) {x is a formal procedural parameter.}
  begin
    write('About to call x ');
    x {call the procedure passed as parameter}
  end;

  procedure b;
  begin
    write('In procedure b')
  end;

  function c(procedure x): integer;
  begin
    x; {call the procedure passed as parameter}
    c:=2
  end;

begin
  a(b); {call a, passing b as parameter}
  i:= c(b) {call c, passing b as parameter}
end.

```

If the actual procedure and the formal procedure have formal-parameter-lists, the formal-parameter-lists must be compatible (see Section 7.3.5). However, only the identifier of the actual procedure is written as an actual parameter; any formal-parameter-list is omitted.

*Example of procedural parameters with their own formal-parameter-lists:*

```

program test;
  procedure xAsPar(y: integer);
  begin
    writeln('y=', y)
  end;

  procedure callProc(procedure xAgain(z: integer));
  begin
    xAgain(1)
  end;

begin {body of program}
  callProc(xAsPar)
end.

```

If the procedural parameter, upon activation, accesses any non-local entity (by variable-reference, procedure-statement, function-call, or label), the entity

accessed must be one that was accessible to the procedure when the procedure was passed as an actual parameter.

To see what this means, consider a procedure `pp` which is known to another procedure, `firstPasser`. Suppose that the following sequence takes place:

1. `firstPasser` is executing.
2. `firstPasser` calls a procedure named `firstReceiver`, passing `pp` as an actual parameter.
3. `firstReceiver` calls `secondReceiver`, again passing `pp` as an actual parameter.
4. `secondReceiver` calls `pp` (first execution of `pp`).
5. `secondReceiver` calls `thirdReceiver`, again passing `pp` as an actual parameter.
6. `thirdReceiver` calls `firstPasser` (indirect recursion), and passes `pp` to `firstPasser` as an actual parameter.
7. `firstPasser` (executing recursively) calls `pp` (second execution of `pp`).

Thus the procedure `pp` is called first from `secondReceiver`, and then from the second (recursive) execution of `firstPasser`.

Suppose that `pp` accesses an entity named `xxx`, which is not local to `pp`; and suppose that each of the other procedures has a local entity named `xxx`.

Each time `pp` is called, which `xxx` does it access? The answer is that in *each* case, `pp` accesses the `xxx` that is local to the *first* execution of `firstPasser`-- that is, the `xxx` that was accessible when `pp` was originally passed as an actual parameter.

#### 7.3.4 Functional Parameters

When the formal parameter is a function-heading, the actual-parameter must be a function-identifier. The identifier in the formal function-heading represents the actual function during the execution of the procedure or function receiving the functional parameter.

Functional parameters are exactly like procedural parameters, with the additional rule that corresponding formal and actual functions must have *identical* result-types.

#### 7.3.5 Parameter List Compatibility

Parameter list compatibility is required of the parameter lists of corresponding formal and actual procedural or functional parameters.



Two formal-parameter-lists are compatible if they contain the same number of parameters and if the parameters in corresponding positions match. Two parameters match if one of the following is true:

- They are both value parameters of *identical* type.
- They are both variable parameters of *identical* type.
- They are both procedural parameters with compatible parameter lists.
- They are both functional parameters with compatible parameter lists and *identical* result-types.

# Chapter 8

## Programs

8.1	Syntax .....	8-1
8.2	Program-Parameters.....	8-1
8.3	Segmentation.....	8-1



# Programs

## 8.1 Syntax

A Pascal program has the form of a procedure declaration except for its heading and an optional *uses-clause*

*program*



*program-heading*

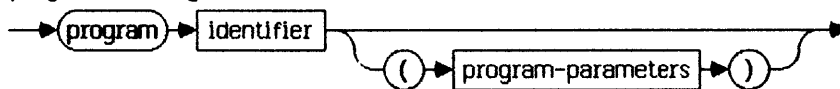

*program-parameters*

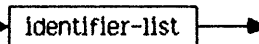

*uses-clause*

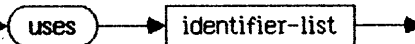

The occurrence of an identifier immediately after the word **program** declares it as the program's identifier.

The *uses-clause* identifies all units required by the program, including units that it uses directly and other units that are used by those units.

## 8.2 Program-Parameters

Currently, any program-parameters are purely decorative and are totally ignored by the compiler.

## 8.3 Segmentation

The code of a program's main body is always placed in a run-time segment whose name is a string of blanks (the "blank segment"). Any other block can be placed in a different segment by using the **\$\$** compiler command (see Chapter 12 and Appendix A). If no **\$\$** command is used in the program, all code is placed in the blank segment. Code from a program can be placed in the same segment with code from a regular-unit, but it cannot be mixed with code from an intrinsic-unit (see Chapter 9).



# Chapter 9

## Units

9.1	Regular-Units .....	9-1
9.1.1	Writing Regular-Units .....	9-1
9.1.2	Using Regular-Units .....	9-3
9.2	Intrinsic-Units .....	9-4
9.3	Units that Use Other Units .....	9-4



# Units

A unit is a separately compiled, non-executable object file that can be linked with other object files to produce complete programs. There are two kinds of units, called *regular-units* and *intrinsic-units*. In the current implementation of the Workshop, you can use intrinsic-units that are provided, but you cannot write new ones.

Each unit used by a program (or another unit) must be compiled, and its object file must be accessible to the compiler, before the host program (or unit) can be compiled.

## 9.1 Regular-Units

Regular-units can be used as a means of modularizing large programs, or of making code available for incorporation in various programs, without making the source available.

When a program or unit (called the *host*) uses a regular-unit, the linker inserts a copy of the compiled code from the regular-unit into the host's object file.

By default, the code copied from the regular-unit is placed in the blank segment (see Chapter 8). The code of the entire unit, or of blocks within the unit, can be placed in one or more different segments by using the `$S` compiler command (see Chapter 12).

### 9.1.1 Writing Regular-Units

The syntax for a regular-unit is:

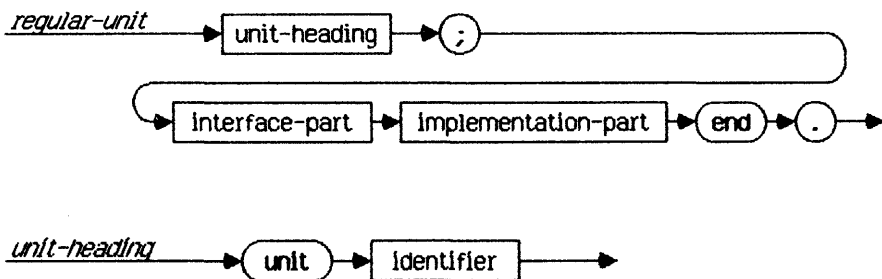



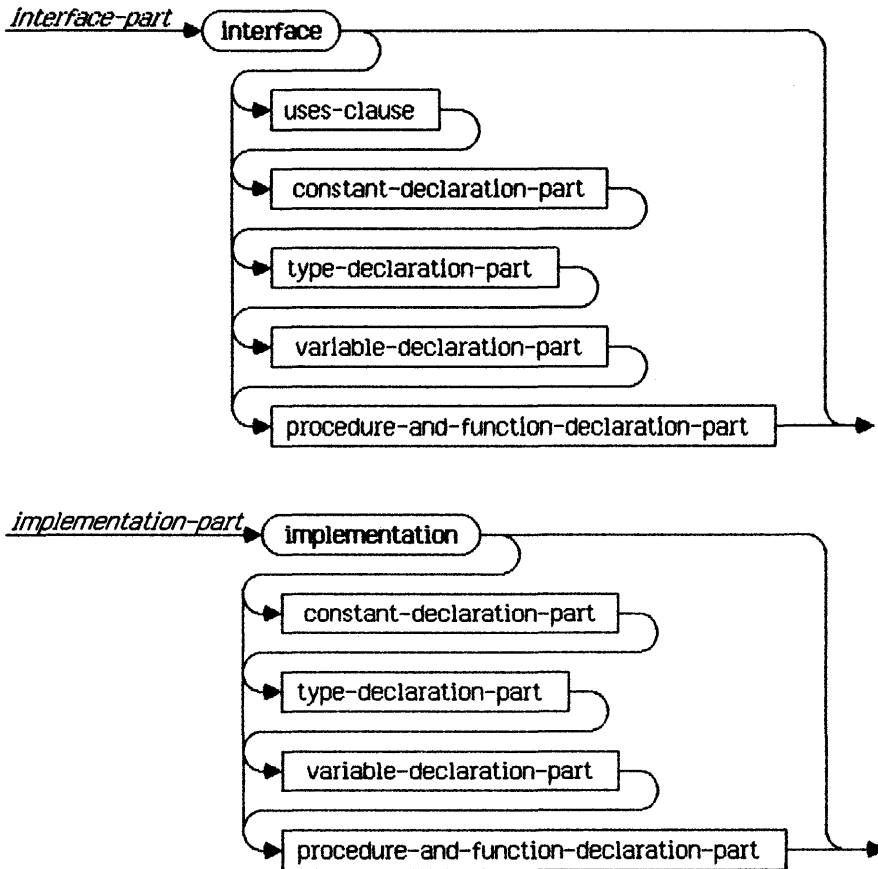

The interface-part declares constants, types, variables, procedures, and functions that are "public," i.e. available to the host.

The host can access these entities just as if they had been declared in the host. Procedures and functions declared in the interface-part are abbreviated to nothing but the procedure or function name, parameter specifications, and function result-type.

**NOTE**

---

Since the interface-part may contain a uses-clause, a unit can use another unit (see Section 9.3).

---

The implementation-part, which follows the last declaration in the interface-part, begins by declaring any constants, types, variables, procedures, or functions that are "private," i.e. not available to the host.

The public procedures and functions are re-declared in the implementation-part. The parameters and function result types are omitted from these declarations, since they were declared in the interface-part, and the procedure and function blocks, omitted in the interface-part, are included in the implementation-part.

In effect, the procedure and function declarations in the interface are like forward declarations, although the `forward` directive is not used. Therefore, these procedures and functions can be defined and referenced in any sequence in the implementation.

---

#### NOTES

---

There is no "Initialization" section in Pascal units on the Lisa (unlike Apple II and Apple III Pascal). If a unit requires initialization of its data, it should define a public procedure that performs the initialization, and the host should call this procedure.

Also note that global labels cannot be declared in a unit.

---

A short example of a unit is:

```

unit Simple;
INTERFACE                {public objects declared}
  const FirstValue=1;
  procedure AddOne(var Incr:integer);
  function Add1(Incr:integer):integer;
IMPLEMENTATION
  procedure AddOne;      {note lack of parameters...}
  begin
    Incr:=Incr+1
  end;
  function Add1;        {...and lack of function result type}
  begin
    Add1:=Incr+1
  end
end.

```

#### 9.1.2 Using Regular-Units

The syntax for a `uses`-clause is given in Section 8.1. Note that in a host program, the `uses`-clause (if any) must immediately follow the program-heading. In a host unit, the `uses`-clause (if any) immediately follows the symbol `interface`. Only one `uses`-clause may appear in any host program or unit; it declares all units used by the host program or unit.

See Section 9.3 for the case where a host uses a unit that uses another unit.

It is necessary to specify the file to be searched for regular units. The \$U compiler command specifies this file. See Chapter 12 for more details.

Assume that the example unit Simple (see above) is compiled to an object file named APPL:SIMPLE.OBJ. The following is a short program that uses Simple. It also uses another unit named Other, which is in file APPL:OTHER.OBJ.

```

program CallSimple;
  uses {$U APPL:SIMPLE.OBJ}    {file to search for units}
      Simple,                 {use unit Simple}
      {$U APPL:OTHER.OBJ}    {file to search for units}
      Other;                  {use unit Other}
  var i:integer;
  begin
    i:=FirstValue;           {FirstValue is from Simple}
    write('i+1 is ',Add1(1)); {Add1 is defined in Simple}
    write(xyz(1))            {xyz is defined in Other}
  end.
  
```

### 9.2 Intrinsic-Units

The only intrinsic-units you can use are the ones provided with the Workshop software.

Intrinsic-units provide a mechanism for Pascal programs to share common code, with only one copy of the code in the system. The code is kept on disk, and when loaded into memory it can be executed by any program that declares the intrinsic-unit (via a uses-clause, the same as for regular-units).

By default, the system looks up all intrinsic-units in the system intrinsics library file, INTRINSIC.LIB. All intrinsic-units are referenced in this library, so the \$U filename compiler command is not needed with intrinsic-units.

### 9.3 Units that Use Other Units

As explained above, the uses-clause in the host must name all units that are used by the host. Here "used" means that the host directly references something in the interface of the unit. Consider the following diagram:

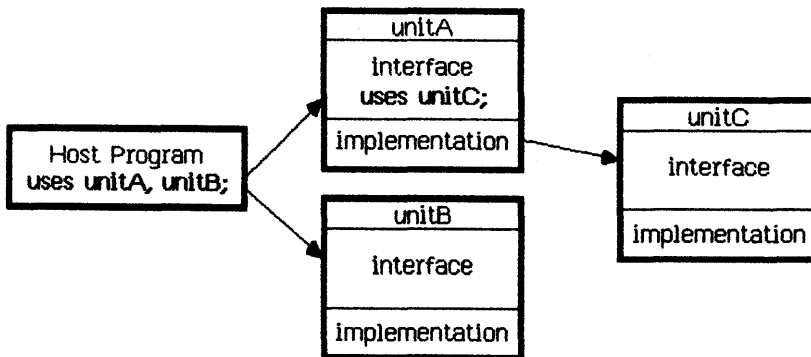

The host program directly references the interfaces of `unitA` and `unitB`; the `uses`-clause names both of these units. The implementation-part of `unitA` also references the interface of `unitC`, but it is not necessary to name `unitC` in the host-program's `uses`-clause.

In some cases, the `uses`-clause must also name a unit that is not directly referenced by the host. The following diagram is exactly like the previous one except that this time the *interface* of `unitA` references the interface of `unitC`, and `unitC` must be named *before* `unitA`.

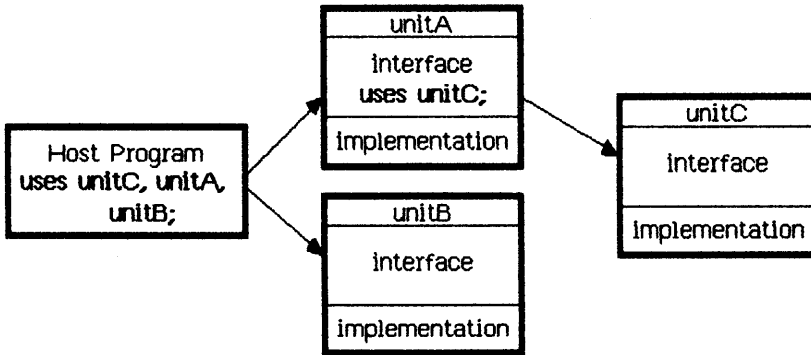

In a case like this, the documentation for `unitA` should state that `unitC` must be named in the `uses`-clause before `unitA`.



# Chapter 10

## Input/Output

<b>10.1</b>	<b>Introduction to I/O</b> .....	<b>10-1</b>
10.1.1	Device Types .....	10-2
10.1.2	External File Species .....	10-2
10.1.3	The Reset Procedure .....	10-3
10.1.4	The Rewrite Procedure .....	10-5
10.1.5	The Close Procedure .....	10-6
10.1.6	The Ioresult Function .....	10-7
10.1.7	The Eof Function .....	10-7
<b>10.2</b>	<b>Record-Oriented I/O</b> .....	<b>10-8</b>
10.2.1	The Get Procedure .....	10-8
10.2.2	The Put Procedure .....	10-8
10.2.3	The Seek Procedure .....	10-9
<b>10.3</b>	<b>Text-Oriented I/O</b> .....	<b>10-9</b>
10.3.1	The Read Procedure .....	10-11
10.3.1.1	Read with a Char Variable .....	10-12
10.3.1.2	Read with an Integer or Longint Variable .....	10-12
10.3.1.3	Read with a Real Variable .....	10-12
10.3.1.4	Read with a String Variable .....	10-13
10.3.1.5	Read with a Packed Array of Char Variable .....	10-13
10.3.2	The Readln Procedure .....	10-14
10.3.3	The Write Procedure .....	10-14
10.3.3.1	Output-Specs .....	10-15
10.3.3.2	Write with a Char Value .....	10-15
10.3.3.3	Write with an Integer or Longint Value .....	10-15
10.3.3.4	Write with a Real Value .....	10-16
10.3.3.5	Write with a String Value .....	10-16
10.3.3.6	Write with a Packed Array of Char Value .....	10-17
10.3.3.7	Write with a Boolean Value .....	10-17
10.3.4	The Writeln Procedure .....	10-17
10.3.5	The Eoln Function .....	10-17
10.3.6	The Page Procedure .....	10-18
10.3.7	Keyboard Testing and Screen Cursor Control .....	10-18
10.3.7.1	The Keypress Function .....	10-18
10.3.7.2	The Gotoxy Procedure .....	10-18

<b>10.4 Untyped File I/O.....</b>	<b>10-18</b>
10.4.1 The Blockread Function .....	10-19
10.4.2 The Blockwrite Function .....	10-20

# Input/Output

This chapter describes the standard ("built-in") I/O procedures and functions of Pascal on the Lisa.

Standard procedures and functions are predeclared. Since all predeclared entities act as if they were declared in a "block" surrounding the program, no conflict arises from a declaration that redefines the same identifier within the program.

---

## NOTE

---

Standard procedures and functions cannot be used as actual procedural and functional parameters.

---

This chapter and Chapter 11 use a modified BNF notation, instead of syntax diagrams, to indicate the syntax of actual-parameter-lists for standard procedures and functions.

*Example:*

*Parameter List:* `new(p [, t1, ... tn ])`

This represents the syntax of the actual-parameter-list of the standard procedure `new`, as follows:

- `p`, `t1`, and `tn` stand for actual-parameters. Notes on the types and interpretations of the parameters accompany the syntax description.
- The notation `t1, ... tn` means that any number of actual-parameters can appear here, separated by commas.
- Square brackets `[ ]` indicate parts of the syntax that can be omitted.

Thus the syntax shown here means that the `p` parameter is required. Any number of `t` parameters may appear, with separating commas, or there may be no `t` parameters.

## 10.1 Introduction to I/O

This section covers the I/O concepts and procedures that apply to all file types. This includes the types `text` (see Section 10.3) and "untyped" files (see Section 10.4).

To use a Pascal file variable (any variable whose type is a file-type), it must be associated with an external file. The external file may be a named collection of information stored on a peripheral device, or (for certain file-types) it may be the peripheral device itself.

The association of a file variable with an external file is made by *opening* the file. An existing file is opened via the `reset` procedure, and a new file is created and opened via the `rewrite` procedure.



---

**NOTE**

---

Pascal on the Lisa does not provide automatic I/O checking. To check the result of any particular I/O operation, use the `ioresult` function described in Section 10.1.6.

---

**10.1.1 Device Types**

For purposes of Pascal I/O, there are two types of peripheral devices:

- A *file-structured* device is one that stores files of data, such as a diskette.
- A *character* device is one whose input and output are streams of individual bytes, such as the Lisa screen and keyboard or a printer.

**10.1.2 External File Species**

There are three "species" of external files that can be used in Pascal I/O operations:

- A *datafile* is any file that is stored on a file-structured device and was *not* originally created in association with a file variable of type `text`.
- A *textfile* is a file that is stored on a file-structured device and was originally created in association with a file variable of type `text`. Textfiles are stored in a specialized format (see Section 10.3).
- A *character device* can be treated as a file.

Table 10-1 summarizes the effects of all possible combinations of different file variable types and external file species. The "ordinary cases" in the table reflect the basic intent of the various file-types. Other combinations, such as block-oriented access to a textfile via a variable of type `file`, are legal but may require cautious programming.

Table 10-1  
 Combinations of File Variable Types with External File Species  
 and Categories

	var f: file of someType;	var f: text;	var f: file;
datafile	<u>Ordinary case.</u> After reset, f <sup>^</sup> = 1st record file.	(Textfile format assumed!) After reset*, f <sup>^</sup> is unspecified.	<u>Ordinary case.</u> Block access.
textfile	(Textfile format not assumed!) After reset*, f <sup>^</sup> = 1st record of file (as declared).	<u>Ordinary case.</u> Textfile format assumed. After reset, f <sup>^</sup> is unspecified.	(Textfile format not assumed!) Block access.
character device	After reset, f <sup>^</sup> = 1st char. from device (system waits for it!). I/O error if file record type not byte-sized.	<u>Ordinary case.</u> After reset, f <sup>^</sup> is unspeci- fied (no wait for input char).	Block access, if allowed by device.
* In these cases, the <i>loresult</i> function will return a "warning" (i.e., a negative number) immediately after the reset operation.			

### 10.1.3 The Reset Procedure

Opens an existing file.

*Parameter List:* reset(f, title)

1. f is a variable-reference that refers to a variable of file-type. The file must not be open.
2. title is an expression with a string value. The string should be a valid pathname for a file on a file-structured device, or a pathname for a character device.

---

**NOTE**

---

Both parameters are required (unlike Apple II and Apple III Pascal, where the second parameter is optional).

---

**Reset(f, title)** finds an existing external file with the pathname **title**, and associates **f** with this external file. (If there is no existing external file with the pathname **title**, an I/O error occurs; see Section 10.1.6.)

If **title** is the pathname of a character device, then

- **Eof(f)** becomes **false**.
- If **f** is of type **text**, the value of  $f^{\wedge}$  is unspecified. The next **read** or **readln** on **f** will wait until a character is available for input, and begin reading with that character.
- If **f** is of type **file** and the device is one that allows block access, there is no file buffer variable  $f^{\wedge}$  and the "current file position" is set to the first block (block 0) of the file. If the device does not allow block access, an I/O error occurs (see Section 10.1.6).
- If **f** is not of type **text** or **file**, its component-type must be a "byte-size" type such as the type **-128..127**. Note that **char** is not a byte-size type! If the component-type of **f** is not byte-size, an I/O error occurs (see Section 10.1.6).

If no I/O error occurs, the system waits until a character is available from the device and then assigns the character's 8-bit code to  $f^{\wedge}$ .

If **title** is the pathname for an existing file on a file-structured device, then

- **Eof(f)** becomes **false** if the external file is not empty. If the external file is empty, **eof(f)** becomes **true**.
- If **f** is not of type **text** or **file**, **reset** sets the "current file position" to the first record in the external file, and assigns the value of this record to the file buffer variable  $f^{\wedge}$ . If the external file is a textfile, the **loresult** function will return a negative number as a warning (see Section 10.1.6).
- If **f** is of type **text**, the value of  $f^{\wedge}$  is unspecified. If the file is a textfile, the next **read** or **readln** on **f** will begin at the first character of **f**. If the file is a datafile, it will be treated as if it were a textfile (see Section 10.3) and the **loresult** function will return a negative number as a warning (see Section 10.1.6).
- If **f** is of type **file**, there is no file buffer variable  $f^{\wedge}$  and the "current file position" is set to the first block (block 0) of the file.

**10.1.4 The Rewrite Procedure**

Creates and opens a new file.

*Parameter List:* **rewrite(f, title)**

1. **f** is a variable-reference that refers to a variable of file-type.
2. **title** is an expression with a string value. The string should be a valid pathname for a file on a file-structured device, or a pathname for a character device.

If **f** is already open, an I/O error occurs (see Section 10.1.6).

If **title** is the pathname of a character device, then

- **Eof(f)** becomes **false**.
- **Rewrite(f, title)** simply associates **f** with the device and opens **f**.
- The status of the device is not affected.
- The value of  $f^{\wedge}$  becomes unspecified.

If **title** is the pathname for a new file on a file-structured device, then

- **Eof(f)** becomes **true**.
- **Rewrite(f, title)** creates a new external file with the pathname **title**, and associates **f** with the external file. This is the only way to create a new external file.
- The species of the new external file is set according to the type of  $f^{\wedge}$ —"textfile" for type **text**, or "datafile" for any other type.
- The value of  $f^{\wedge}$  becomes unspecified.
- If **f** is not of type **file**, the "current file position" is set to just before the first record or character position of the new external file.
- If **f** is of type **file**, the "current file position" is set to block 0 (the first block in the file).
- If **f** is subsequently closed with any option other than **lock** or **crunch** (see Section 10.1.5), the new external file is discarded at that time. Closing **f** with **lock** or **crunch** is the only way to make the new external file permanent.
- If **title** is the pathname of an existing external file, the existing file will be discarded only when **f** is subsequently closed with the **lock** or **crunch** option (see Section 10.1.5).

Unspecified effects are caused if the current file position of a file **f** is altered while the file-buffer  $f^{\wedge}$  is an actual variable parameter, or an element of the record-variable-reference list of a **with**-statement, or both.

**10.1.5 The Close Procedure**

Closes a file.

*Parameter List:* `close(f [, option])`

1. `f` is a variable-reference that refers to a variable of file-type.
2. `option` (may be omitted) is an identifier from the list given below. If omitted, the effect is the same as using the identifier **normal**.

`Close(f, option)` closes `f`, if `f` is open. The association between `f` and its external file is broken and the file system marks the external file "closed". If `f` is not open, the `close` procedure has no effect.

The `option` parameter controls the disposition of the external file, if it is not a character device. If it is a character device, `f` is closed and the status of the device is unchanged.

The identifiers that can be used as actual-parameters for `option` are as follows:

- **normal** -- If `f` was opened using `rewrite`, it is deleted from the directory. If `f` was opened with `reset`, it remains in the directory. This is the default option, in the case where the `option` parameter is omitted.
- **lock** -- If the external file was opened with `rewrite`, it is made permanent in the directory.

If `f` was opened with `rewrite` and a title that matches an existing file, the old file is deleted (unless the safety switch is "on"). If the old file has the safety switch "on," it remains in the directory and the new file is deleted.

If `f` was opened with `reset`, a **normal** close is done.

- **purge** -- The external file is deleted from the directory (unless the safety switch is "on"). In the special case of a file that already exists and is opened with `rewrite`, the original file remains in the directory, unchanged.
- **crunch** -- This is like **lock** except that it locks the end-of-file to the point of last access; i.e., everything after the last record or character accessed is thrown away.

All closes regardless of the `option` will cause the file system to mark the external file "closed" and will make the value of `f` unspecified.

If a program terminates with a file open (i.e., if `close` is omitted), the system automatically closes the file with the **normal** option.

---

**NOTE**

---

If you open an existing file with `reset` and modify the file with any write operation, the contents are immediately changed no matter what `close` option you specify.

---

**10.1.6 The Ioresult Function**

Pascal on the Lisa does not provide automatic I/O checking. To check the result of any particular I/O operation, you must use the `ioresult` function.

*Result type:* Integer

*Parameter List:* no parameters

`ioresult` returns an integer value which reflects the status of the last completed I/O operation. The codes are given in the *Workshop User's Guide for the Lisa*. Note that the code 0 indicates successful completion, positive codes indicate errors, and negative codes are "warnings" (see Table 10-1).

Note that the codes returned by `ioresult` are not the same as the codes used in Apple II and Apple III Pascal.

---

**NOTES**

---

The `read`, `readln`, `write`, and `writeln` procedures described in Section 10.3 may actually perform multiple I/O operations on each call. After one of these procedures has executed, `ioresult` will return a code for the status of the *last* of the multiple operations.

Also, beware of the following common error in diagnostic code:

```
read(foo);
writeln('ioresult=', ioresult)
```

The intention is to write out the status of the read operation, but instead the status written out will be that of the write operation on the string 'ioresult-'.

---

**10.1.7 The Eof Function**

Detects the end of a file.

*Result Type:* boolean

*Parameter List:* eof [(f)]

1. `f` is a variable-reference that refers to a variable of file-type.

If the parameter-list is omitted, the function is applied to the standard file `input` (see Section 10.3).

After a `get` or `put` operation, `eof(f)` returns `true` if the current file position is beyond the last external file record, or the external file contains no records; otherwise, `eof(f)` returns `false`. Specifically, this means the following:

- After a `get`, `eof(f)` returns `true` if the `get` attempted to read beyond the last file record (or the file is empty).
- After a `put`, `eof(f)` returns `true` if the record written by the `put` is now the last file record.

If  $f$  is a character device,  $\text{eof}(f)$  will always return **false**.

See Section 10.3 for the behavior of  $\text{eof}(f)$  after a **read** or **readln** operation.

---

**NOTE**

---

Whenever  $\text{eof}(f)$  is **true**, the value of the file buffer variable  $f^{\wedge}$  is unspecified.

---

## 10.2 Record-Oriented I/O

This section covers the **get**, **put**, and **seek** procedures, which perform record-oriented I/O; that is, they consider a file to be a sequence of variables of the type specified in the file-type. These procedures are not allowed with files of type **file**.

The effects of **get** and **put** are unspecified with files of type **text**, and **seek** has no effect with files of type **text**. The **text** type is supported by specialized procedures described in Section 10.3.

### 10.2.1 The Get Procedure

Reads the next record in a file.

*Parameter List:* **get**( $f$ )

1.  $f$  is a variable-reference that refers to a variable of file-type. The file must be open.

If  $\text{eof}(f)$  is **false**, **get**( $f$ ) advances the current file position to the next file record, and assigns the value of this record to  $f^{\wedge}$ . If no next component exists, then  $\text{eof}(f)$  becomes **true**, and the value of  $f^{\wedge}$  becomes unspecified.

If  $\text{eof}(f)$  is **true** when **get**( $f$ ) is called, then  $\text{eof}(f)$  remains **true**, and the value of  $f^{\wedge}$  becomes unspecified.

If the external file is a character device,  $\text{eof}(f)$  is always **false** and there is no "current file position." In this case, **get**( $f$ ) waits until a value is ready for input and then assigns the value to  $f^{\wedge}$ .

### 10.2.2 The Put Procedure

Writes the current record in a file.

*Parameter List:* **put**( $f$ )

1.  $f$  is a variable-reference that refers to a variable of file-type. The file must be open.

If  $\text{eof}(f)$  is **false**, **put**( $f$ ) advances the current file position to the next file record and then writes the value of  $f^{\wedge}$  to  $f$  at the new file position. If the new file position is beyond the end of the file,  $\text{eof}(f)$  becomes **true**, and the value of  $f^{\wedge}$  becomes unspecified.

If  $\text{eof}(f)$  is **true**, **put**( $f$ ) appends the value of  $f^{\wedge}$  to the end of  $f$  and  $\text{eof}(f)$  remains **true**.

If the external file is a character device, `eof(f)` is always `false`, there is no "current file position," and the value of `f` is sent to the device.

---

**NOTE**

---

If `put` is called immediately after a file is opened with `reset`, the `put` will write the *second* record of the file (since the `reset` sets the current position to the first record and `put` advances the position before writing). To get around this and write the first record, use the `seek` procedure (see Section 10.2.3).

---

### 10.2.3 The Seek Procedure

Allows access to an arbitrary record in a file.

*Parameter List:* `seek(f, n)`

1. `f` is a variable-reference that refers to a variable of file-type. The file must be open.
2. `n` is an expression with an `integer` value that specifies a record number in the file. Note that records in files are numbered from 0.

If the file is a character device or is of type `text`, `seek` does nothing. Otherwise, `seek(f, n)` affects the action of the next `get` or `put` from the file, forcing it to access file record `n` instead of the "next" record. `Seek(f, n)` does not affect the file-buffer `f`.

A `get` or `put` *must* be executed between `seek` calls. The result of two consecutive `seeks` with no intervening `get` or `put` is unspecified. Immediately after a `seek(f, n)`, `eof(f)` will return `false`; a following `get` or `put` will cause `eof` to return the appropriate value.

---

**NOTE**

---

The record number specified in a `seek` call is not checked for validity. If the number is not the number of a record in the file and the program tries to `get` the specified record, the value of the file-buffer becomes unspecified and `eof` becomes `true`.

---

## 10.3 Text-Oriented I/O

This section describes input and output using file variables of the standard type `text`. Note that in Pascal on the Lisa, the type `text` is distinct from file of `char` (see Section 3.2.4).

When a `text` file is opened, the external file is interpreted in a special way. It is considered to represent a sequence of characters, usually formatted into *lines* by CR characters (ASCII 13).

The Lisa keyboard and the Workshop screen appear to a Pascal program to be built-in files of type `text` named `input` and `output` respectively. These files



need not be declared and need not be opened with `reset` or `rewrite`, since they are always open.

When a program is taking input from `input`, typed characters are echoed on the Workshop screen. In addition to the `input` file, the Lisa keyboard is also represented as the character device `-KEYBOARD`. To get keyboard input without echoing on the screen, you can open a file variable of type `text` with `-KEYBOARD` as the external file pathname.

Other interactive devices can also be represented in Pascal programs as files of type `text`.

When a `text` file is created on a file-structured device, the external file is a `textfile`. It contains information other than the actual sequence of characters represented, as follows:

- The stored file is a sequence of 1024-byte *pages*.
- Each page contains some number of *complete* lines of text and is padded with null characters (ASCII 0) after the last line.
- Two 512-byte *header blocks* are also present at the beginning of the file.
- A sequence of spaces in the text *may* be compressed into a two-byte code, namely a *DLE character* (ASCII 16) followed by a byte containing 32 plus the number of spaces represented.

All of this special formatting is invisible to a Pascal program if the file is accessed via a file variable of type `text` (but visible via a file variable of any other file-type).

Certain things that can be done with a record-structured file are impossible with a file variable of type `text`:

- The `seek` procedure does nothing with a file variable of type `text`.
- The effects of `get` and `put` are unspecified with a file variable of type `text`.
- The contents of the file buffer variable are unspecified with a file variable of type `text`.
- A file variable of type `text` that is opened with `reset` cannot be used for output, and one opened with `rewrite` cannot be used for input. Results are unspecified if either of these operations is attempted.

In place of these capabilities, text-oriented I/O provides the following:

- Automatic conversion of each input CR character into a space.
- The `eofln` function to detect when the end of an input line has been reached.
- The `read` procedure, which can read `char` values, string values, **packed array** of `char` values, and numeric values (from textual representations).

- The **write** procedure, which can write **char** values, string values, **packed array of char** values, numeric values, and **boolean** values (as textual representations).
- Line-oriented reading and writing via the **readln** and **writeln** procedures.
- The **page** procedure, which outputs a form-feed character to the external file.
- Automatic conversion of input DLE-codes to the sequences of spaces that they represent. Note that output sequences of spaces are not converted to DLE-codes.
- Automatic skipping of header blocks and null characters during input.
- Automatic generation of textfile header blocks, and automatic padding of textfile pages with null characters on output.

### 10.3.1 The Read Procedure

Reads one or more values from a text file into one or more program variables.

*Parameter List:* `read( [f,] v1 [, v2, ... vn] )`

The syntax of the parameter-list of **read** allows an indefinite number of actual-parameters. Consecutive actual-parameters are separated by commas, just as in a normal parameter-list.

1. **f** (may be omitted) is a variable-reference that refers to a variable of type **text**. The file must be open. If **f** is omitted, the procedure reads from the standard **text** file **input**, which represents the Lisa keyboard.
2. **v1 ... vn** are *input variables*. Each is a variable parameter, used as a destination for data read from the file. Each input variable must be a variable-reference that refers to a variable of one of the following types:
  - **char**, **integer**, or **longint** (or a subrange of one of these)
  - **real**
  - a string-type or a **packed array of char** type.

These are the types of data that can be read (as textual representations) from a file. At least one input variable must be present.

**Read(f,v1,...,vn)** is equivalent to:

```
begin
  read(f, v1);
  ...
  read(f, vn)
end
```

---

**NOTE**

---

**Read** can also be used to read from a file *fil* that is not a *text* file. In this case **read(fil,x)** is equivalent to:

```
begin
  x := fil^;
  get(fil)
end
```

---

**10.3.1.1 Read with a Char Variable**

If *f* is of type *text* and *v* is of type *char*, the following things are true immediately after **read(f,v)**:

- **Eof(f)** will return **true** if the read attempted to read beyond the last character in the external file.
- **Eoln(f)** will return **true**, and the value of *v* will be a space, if the character read was the CR character. **Eoln(f)** will also return **true** if **eof(f)** is **true**.

**10.3.1.2 Read with an Integer or Longint Variable**

If *f* is of type *text* and *v* is of type *integer*, subrange of *integer*, or *longint*, then **read(f,v)** implies the reading from *f* of a sequence of characters that form a signed whole number according to the syntax of Section 1.4 (except that hexadecimal notation is not allowed). If the value read is assignment-compatible with the type of *v*, it is assigned to *v*; otherwise an error occurs.

In reading the sequence of characters, preceding blanks and CRs are skipped. Reading ceases as soon as a character is reached that, together with the characters already read, does not form part of a signed whole number.

An error occurs if a signed whole number is not found after skipping any preceding blanks and CRs.

If *f* is of type *text*, the following things are true immediately after **read(f,v)**:

- **Eof(f)** will return **true** if the last character in the numeric string was the last character in the external file.
- **Eoln(f)** will return **true** if the last character in the numeric string was the last character on the line (not counting the CR character). **Eoln(f)** will also return **true** if **eof(f)** is **true**.

**10.3.1.3 Read with a Real Variable**

If *f* is of type *text* and *v* is of type *real*, then **read(f,v)** implies the reading from *f* of a sequence of characters that represents a real value. The real value is assigned to the variable *v*.

In reading the sequence of characters, preceding blanks and CRs are skipped. Reading ceases as soon as a character is reached that, together with the

characters already read, does not form a valid representation. A "valid representation" is either of the following:

- A finite **real**, **integer**, or **longint** value represented according to the signed-number syntax of Section 1.4 (except that hexadecimal notation is not allowed). An **integer** or **longint** value is converted to type **real**.
- An infinite value or Nan represented as described in Appendix D.

An error occurs if a valid representation is not found after skipping any preceding blanks and CRs.

Immediately after **read(f,v)** where **v** is a **real** variable, the status of **eof(f)** and **eoln(f)** are the same as for an **integer** variable (see Section 10.3.1.2 above).

#### 10.3.1.4 Read with a String Variable

If **f** is of type **text** and **v** is of string-type, then **read(f,v)** implies the reading from **f** of a sequence of characters up to *but not including* the next CR or the end of the file. The resulting character-string is assigned to **v**. An error occurs if the number of characters read exceeds the size attribute of **v**.

---

#### NOTE

**Read** with a string variable does not skip to the next line after reading, and the CR is left waiting in the input buffer. For this reason, you cannot use successive **read** calls to read a sequence of strings, as they will never get past the first CR -- after the first **read**, each subsequent **read** will see the CR and will read a zero-length string.

Instead, use **readln** to read string values (see Section 10.3.2). **Readln** skips to the beginning of the next line after reading.

---

The following things are true immediately after **read(f,v)**:

- **Eof(f)** will return **true** if the line read was the last line in the file.
- **Eoln(f)** will always return **true**.

#### 10.3.1.5 Read with a Packed Array of Char Variable

If **f** is of type **text** and **v** is a **packed array of char**, then **read(f,v)** implies the reading from **f** of a sequence of characters. Characters are read into successive character positions in **v** until all positions have been filled, or until a CR or the end of the file is encountered. If a CR or the end-of-file is encountered, it is not read into **v**; the remaining positions in **v** are filled with spaces.

### 10.3.2 The Readln Procedure

The `readln` procedure is an extension of `read`. Essentially it does the same thing as `read`, and then skips to the next line in the input file.

*Parameter List:* The syntax of the parameter list of `readln` is the same as that of `read`, except as follows:

- A `readln` call with no input variables is allowed. *Example:*

```
readln(sourcefile)
```

- The parameter-list can be omitted altogether.

If the first parameter does not specify a file, or if the parameter-list is omitted, the procedure reads from the standard file `input`, which represents the Lisa keyboard.

`Readln(f)`, with no input-variables, causes a skip to the beginning of the next line (if there is one, else to the end-of-file).

`Readln` can *only* be used on a text file. Except for this restriction, `readln(f,v1,...,vn)` is equivalent to:

```
begin
  read(f,v1,...,vn);
  readln(f)
end
```

The following things are true immediately after `readln(f,v)`, regardless of the type of `v`:

- `Eof(f)` will return `true` if the line read was the last line in the external file.
- `Eoln(f)` will always return `false`.

### 10.3.3 The Write Procedure

Writes one or more values to a text file.

*Parameter List:* `write([f,] p1 [, p2, ... pn])`

The syntax of the parameter list of `write` allows an indefinite number of actual-parameters.

1. `f` (may be omitted) is a variable-reference that refers to a variable of type `text`. The file must be open. If `f` is omitted, the procedure writes to the standard file `output`, which represents the Workshop screen.
2. `p1 ... pn` are *output-specs*. Each output-spec includes an *output expression*, whose value is to be written to the file. As explained below, an output-spec may also contain specifications of field-width and number of decimal places. Each output expression must have a result of type `integer`, `longint`, `real`, `boolean`, `char`, a string-type, or a `packed array` of `char` type. These are the types of data that can be written (as textual representations) to a file. At least one output-spec must be present.

`write(f,p1,...,pn)` is equivalent to:

```
begin
  write(f,p1);
  ...
  write(f,pn)
end
```

Immediately after `write(f)`, both `eof(f)` and `eoln(f)` will return `true`.

---

NOTE

---

`write` can also be used to write onto a file `fil` that is not a `text` file. In this case `write(fil,x)` is equivalent to:

```
begin
  fil := x;
  put(fil)
end
```

---

### 10.3.3.1 Output-Specs

Each output-spec has the form

```
OutExpr [ : Minwidth [ : DecPlaces ] ]
```

where `OutExpr` is an output expression. `Minwidth` and `DecPlaces` are expressions with `integer` or `longint` values.

`Minwidth` specifies the *minimum* field width, with a default value that depends on the type of the value of `OutExpr` (see below). `Minwidth` should be greater than zero; otherwise, the results are unspecified. Exactly `Minwidth` characters are written (using leading spaces if necessary), except when `OutExpr` has a *numeric* value that requires more than `Minwidth` characters; in this case, enough characters are written to represent the value of `OutExpr`.

`DecPlaces` specifies the number of decimal places in a fixed-point representation of a *real* value. It can be specified only if `OutExpr` has a *real* value, and if `Minwidth` is also specified. If `DecPlaces` is not specified, a floating-point representation is written.

### 10.3.3.2 Write with a Char Value

If `OutExpr` has a *char* value, the character is written on the file `f`. The default value for `Minwidth` is one.

### 10.3.3.3 Write with an Integer or Longint Value

If `OutExpr` has an *integer* or *longint* value, its decimal representation is written on the file `f`. The default value for `Minwidth` is 8. The representation consists of the digits representing the value, prefixed by a minus sign if the value is negative, and any leading spaces that may be required to satisfy `Minwidth`. If the representation requires more than `Minwidth` characters, `Minwidth` is ignored.

#### 10.3.3.4 Write with a Real Value

If `OutExpr` has a real value, the default value for `MinWidth` is 12.

If `OutExpr` has an infinite value, it is output as a string of at least two "+" characters or at least two "-" characters. If `OutExpr` is a NaN, it is output as the character string "NaN", possibly followed by a string of characters enclosed by single-quotes. See Section 10.3.3.5 for details on string output.

If `OutExpr` has a zero value, it is represented as "0" or "-0".

If `OutExpr` has a finite value, its decimal representation is written on the file `f`. This representation is the nearest possible decimal representation, depending on `MinWidth` and `DecPlaces`. If the unrounded value is exactly halfway between two possible representations, the representation whose least significant digit is even is written out.

If `DecPlaces` is not specified, a *floating-point* representation is written as follows:

- If `MinWidth` is less than 6, then its value is set to 6 (internally). This is the minimum usable width for writing a floating-point representation.
- If the sign of the value of `OutExpr` is negative, a minus sign is written; otherwise, a space is written.
- If `MinWidth`  $\geq$  8, the significant digits are written with one digit to the left of the decimal point and (`MinWidth` - 7) digits to the right of the decimal point.
- If `MinWidth` < 8, the most significant digit is written and the decimal point is omitted.
- The exponent is written as the letter "E", an explicit "+" or "-" sign, and two digits.

If `DecPlaces` is specified, a *fixed-point* representation is written as follows:

- Enough leading spaces are written to satisfy `MinWidth`.
- If the value is negative, the minus sign "-" is written; if it is not negative, a space is written.
- If `DecPlaces` > 0, the significant digits are written with the integer part of the value to the left of the decimal point. The next `DecPlaces` digits are written to the right of the decimal point.
- If `DecPlaces`  $\leq$  0, only the integer part of the value is written and no decimal point is written.

#### 10.3.3.5 Write with a String Value

If the value of `OutExpr` is of string type with length `L`, the default value for `MinWidth` is `L`. If `MinWidth` > `L`, the value is written on the file `f` preceded by (`MinWidth`-`L`) spaces. If `MinWidth` < `L`, the first `MinWidth` characters of the string are written.

**10.3.3.6 Write with a Packed Array of Char Value**

If *E* is of type **packed array of char**, the effect is the same as writing a string whose length is the number of elements in the array.

**10.3.3.7 Write with a Boolean Value**

If the value of *OutExpr* is of type **boolean**, the string " TRUE" (with a leading space) or the string "FALSE" is written on the file *f*. The default value of *MinWidth* is 5. If *MinWidth*>5, leading spaces are added; if *MinWidth*<5, the first *MinWidth* characters of the string are written. This is equivalent to:

```
write(f, ' TRUE':MinWidth)
or
write(f, 'FALSE':MinWidth)
```

**10.3.4 The Writeln Procedure**

The **writeln** procedure is an extension of **write**. Essentially it does the same thing as **write**, and then writes a CR character to the output file (ending the line).

*Parameter List:* The syntax of the parameter list of **writeln** is the same as that of **write**, except as follows:

- A **writeln** call with no output-specs is allowed. *Example:*

```
writeln(outputfile)
```

- The parameter-list can be omitted altogether.

If the first parameter does not specify a file, or if the parameter-list is omitted, the procedure writes to the standard file **output**, which represents the Workshop screen.

**writeln(f)** writes a CR character to the file *f*.

**writeln** can *only* be used on a **text** file. Except for this restriction, **writeln(f,p1,...,pn)** is equivalent to:

```
begin
  write(f,p1,...,pn);
  writeln(f)
end
```

Immediately after **writeln(f)**, both **eof(f)** and **eoln(f)** will return **true**.

**10.3.5 The Eoln Function**

*Result Type:* **boolean**

*Parameter List:* **eoln[(f)]**

1. *f* is a variable-reference that refers to a variable of type **text**. The file must be open.

The actual-parameter-list can be omitted entirely. In this case, the function is applied to the standard file **input** (the Lisa keyboard).



**Eoln(f)** returns true "if the end of a line has been reached in f." The meaning of this depends on whether the external file is a character device, on which I/O procedure was executed last, and on what type of variable was used to receive an input value. For details, see Sections 10.3.1 through 10.3.4.

The end of the file is considered to be the end of a line; therefore **eoln(f)** will return true whenever **eoff(f)** is true.

### 10.3.6 The Page Procedure

*Parameter List:* **page(f)**

1. **f** is a variable-reference that refers to a variable of type **text**. The file must be open.

The actual-parameter **f** cannot be omitted. **Page(f)** outputs a form-feed character to the file **f**. This will cause a skip to the top of a new page when **f** is printed.

Note that **page(output)** sends a form-feed to the Workshop screen, but in general this will not clear the screen. For methods of clearing the screen, see the *Workshop User's Guide for the Lisa*.

### 10.3.7 Keyboard Testing and Screen Cursor Control

#### 10.3.7.1 The Keypress Function

Tests the Lisa keyboard to see if it has a character awaiting input.

*Parameter List:* no parameters.

*Result Type:* **boolean**.

**Keypress** returns true if a character has been typed on the Lisa keyboard but has not yet been read, or false otherwise. This is done by testing the typeahead queue; if the queue is empty, **keypress** is false, otherwise it is true.

#### 10.3.7.2 The Gotoxy Procedure

Moves the Workshop screen cursor to a specified location on the screen.

*Parameter List:* **gotoxy(x, y)**

1. **x** is an expression with an integer value. If **x** < 0, the value 0 will be used; if **x** > 79, the value 79 will be used.
2. **y** is an expression with an integer value. If **y** < 0, the value 0 will be used; if **y** > 31, the value 31 will be used.

**Gotoxy(x, y)** moves the cursor to the point (x,y) on the screen. Note that the point (0,0) is the upper left corner of the screen.

### 10.4 Untyped File I/O

Untyped file I/O operates on an "untyped file," i.e., a variable of type **file** (no component type). An untyped file is treated as a sequence of 512-byte *blocks*; the bytes are not type-checked but considered as raw data. This can be useful for applications where the data need not be interpreted at all during I/O operations.

The blocks in an untyped file are considered to be numbered sequentially starting with 0. The system keeps track of the *current block number*; this is block 0 immediately after the file is opened. Each time a block is read, the current block number is incremented. By default, each I/O operation begins at the current block number; however, an arbitrary block number can be specified.

An untyped file has no file-buffer, and it cannot be used with `get`, `put`, or any of the text-oriented I/O procedures. It can only be used with `reset`, `rewrite`, `close`, `eof`, and the `blockread` and `blockwrite` functions described below.

To use untyped file I/O, an untyped file is opened with `reset` or `rewrite`, and the `blockread` and `blockwrite` functions are used for input and output.

#### 10.4.1 The Blockread Function

Reads one or more 512-byte blocks of data from an untyped file to a program variable, and returns the number of blocks read.

*Result Type:* Integer

*Parameter List:* `blockread(f, databuf, count [, blocknum])`

1. `f` is a variable-reference that refers to a variable of type file. The file must be open.
2. `databuf` is a variable-reference that refers to the variable into which the blocks of data will be read. The size and type of this variable are not checked; if it is not large enough to hold the data, other program data may be overwritten and the results are unpredictable.
3. `count` is an expression with an integer value. It specifies the maximum number of blocks to be transferred. `Blockread` will read as many blocks as it can, up to this limit.
4. `blocknum` (may be omitted) is an expression with an integer value. It specifies the starting block number for the transfer. If it is omitted, the transfer begins with the current block. Thus the transfers are sequential if the `blocknumber` parameter is never used; if a `blocknumber` parameter is used, it provides random access to blocks.

`Blockread(f, databuf, count, blocknum)` reads blocks from `f` into `databuf`, starting at block `blocknum`. `Count` is the maximum number of blocks read; if the end-of-file is encountered before `count` blocks are read, the transfer ends at that point. The value returned is the number of blocks actually read.

If the last block in the file was read, the current block number is unspecified and `eof(f)` is true. Otherwise, `eof(f)` is false and the current block number is advanced to the block after the last block that was read.

### 10.4.2 The Blockwrite Function

Writes one or more 512-byte blocks of data from a program variable to an untyped file, and returns the number of blocks written.

*Result Type:* Integer

*Parameter List:* `blockwrite(f, databuf, count [, blocknum])`

1. `f` is a variable-reference that refers to a variable of type file. The file must be open.
2. `databuf` is a variable-reference that refers to the variable from which the blocks of data will be written. The size and type of this variable are not checked.
3. `count` is an expression with an integer value. It specifies the maximum number of blocks to be transferred. `Blockwrite` will write as many blocks as it can, up to this limit.
4. `blocknum` (may be omitted) is an expression with an integer value. It specifies the starting block number for the transfer. If it is omitted, the transfer begins with the current block. Thus the transfers are sequential if the `blocknumber` parameter is never used; if a `blocknumber` parameter is used, it provides random access to blocks.

`Blockwrite(f, databuf, count, blocknum)` writes blocks into `f` from `databuf`, starting at block `blocknum`. `Count` is the maximum number of blocks written; if disk space runs out before `count` blocks are written, the transfer ends at that point. The value returned is the number of blocks actually written.

If disk space ran out, the current block number is unspecified. Otherwise, the current block number is advanced to the block after the last block that was written.

---

#### NOTE

Unlike Apple II and Apple III Pascal, this Pascal does not allow `blockwrite` to write a block at a position beyond the first position after the current end of the file. In other words, you cannot create a block file with gaps in it.

---

# Chapter 11

## Standard Procedures and Functions

<b>11.1</b>	<b>Exit and Halt Procedures</b> .....	<b>11-1</b>
11.1.1	The Exit Procedure .....	11-1
11.1.2	The Halt Procedure .....	11-1
<b>11.2</b>	<b>Dynamic Allocation Procedures</b> .....	<b>11-1</b>
11.2.1	The New Procedure .....	11-2
11.2.2	The HeapResult Function .....	11-3
11.2.3	The Mark Procedure .....	11-3
11.2.4	The Release Procedure .....	11-3
11.2.5	The Memavail Function .....	11-3
<b>11.3</b>	<b>Transfer Functions</b> .....	<b>11-4</b>
11.3.1	The Trunc Function .....	11-4
11.3.2	The Round Function .....	11-4
11.3.3	The Ord4 Function .....	11-4
11.3.4	The Pointer Function .....	11-5
<b>11.4</b>	<b>Arithmetic Functions</b> .....	<b>11-5</b>
11.4.1	The Odd Function .....	11-5
11.4.2	The Abs Function .....	11-5
11.4.3	The Sqr Function .....	11-6
11.4.4	The Sin Function .....	11-6
11.4.5	The Cos Function .....	11-6
11.4.6	The Exp Function .....	11-6
11.4.7	The Ln Function .....	11-7
11.4.8	The Sqrt Function .....	11-7
11.4.9	The Arctan Function .....	11-7
11.4.10	The Pwroften Function .....	11-7
<b>11.5</b>	<b>Ordinal Functions</b> .....	<b>11-8</b>
11.5.1	The Ord Function .....	11-8
11.5.2	The Chr Function .....	11-8
11.5.3	The Succ Function .....	11-8
11.5.4	The Pred Function .....	11-9

- 11.6 String Procedures and Functions ..... 11-9**
  - 11.6.1 The Length Function..... 11-9
  - 11.6.2 The Pos Function ..... 11-9
  - 11.6.3 The Concat Function ..... 11-10
  - 11.6.4 The Copy Function ..... 11-10
  - 11.6.5 The Delete Procedure ..... 11-10
  - 11.6.6 The Insert Procedure ..... 11-10
  
- 11.7 Byte-Oriented Procedures and Functions ..... 11-11**
  - 11.7.1 The Moveleft Procedure ..... 11-11
  - 11.7.2 The Moveright Procedure ..... 11-12
  - 11.7.3 The Sizeof Function ..... 11-12
  
- 11.8 Packed Array of Char Procedures and Functions ..... 11-12**
  - 11.8.1 The Scaneq Function ..... 11-12
  - 11.8.2 The Scanne Function ..... 11-13
  - 11.8.3 The Fillchar Procedure ..... 11-13

# Standard Procedures and Functions

This chapter describes all the standard ("built-in") procedures and functions in Pascal on the Lisa, except for the I/O procedures and functions described in Chapter 10.

Standard procedures and functions are predeclared. Since all predeclared entities act as if they were declared in a block surrounding the program, no conflict arises from a declaration that redefines the same identifier within the program.

---

## NOTE

Standard procedures and functions cannot be used as actual procedural and functional parameters.

---

This chapter uses a modified BNF notation, instead of syntax diagrams, to indicate the syntax of actual-parameter-lists for standard procedures and functions. The notation is explained at the beginning of Chapter 10.

### 11.1 Exit and Halt Procedures

#### 11.1.1 The Exit Procedure

Exits immediately from a specified procedure or function, or from the main program.

*Parameter List:* `exit(id)`

1. `id` is the identifier of a procedure or function, or of the main program. If `id` is an identifier defined in the program, it must be in the scope of the `exit` call. Note that this is more restricted than UCSD Pascal.

`Exit(id)` causes an immediate exit from `id`. Essentially, it causes a jump to the end of `id`.

---

## NOTE

The `halt` procedure (see below) can be used to exit the main program from a `unit` without knowing the main program's identifier.

---

#### 11.1.2 The Halt Procedure

Exits immediately from the main program.

*Parameter List:* no parameters

`Halt` causes an immediate exit from the main program.

### 11.2 Dynamic Allocation Procedures

These procedures are used to manage the *heap*, a memory area that is unallocated when the program starts running. The procedure `new` is used for

all allocation of heap space by the program. The `mark` and `release` procedures are used together to deallocate heap space, and the `heapresult` function is used to return the status of the last preceding dynamic allocation operation..

### 11.2.1 The New Procedure

Allocates a new dynamic variable and sets a pointer variable to point to it.

*Parameter List:* `new(p [, t1, ... tn ])`

1. `p` is a variable-reference that refers to a variable of any pointer-type. This is a variable parameter.
2. `t1, ... tn` are constants, used only when allocating a variable of record-type with variants (see below).

`New(p)` allocates a new variable of the base-type of `p`, and makes `p` point to it. The variable can be referenced as `p`. Successive calls to `new` allocate contiguous areas.

If the heap does not contain enough free space to allocate the new variable, `p` is set to `nil` and a subsequent call to the `heapresult` function will return a non-zero result.

If the base-type of `p` is a record-type with variants, `new(p)` allocates enough space to allow for the largest variant. The form

`new(p, t1, ...tn)`

allocates a variable with space for the variants specified by the tag values `t1, ... tn` (instead of enough space for the largest variants). The tag values must be constants. They must be listed contiguously and in the order of their declaration. The tag values are not assigned to the tag-fields by this procedure.

Trailing tag values can be omitted. The space allocated allows for the largest variants for all tag-values that are not specified.

---

#### WARNING

---

When a record variable is dynamically allocated with explicit tag values as shown above, you should not make assignments to any fields of variants that are not selected by the tag values. Also, you should not assign an entire record to this record. If you do either of these things, other data can be overwritten without any error being detected at compile time.

---

### 11.2.2 The Heapresult Function

Returns the status of the most recent dynamic allocation operation.

*Result Type:* integer

*Parameter List:* no parameters

**Heapresult** returns an integer code that reflects the status of the most recent call on **new**, **mark**, **release**, or **memavail**. The codes are given in the *Workshop User's Guide*; note that the code for a successful operation is 0.

### 11.2.3 The Mark Procedure

Sets a pointer to a heap area.

*Parameter List:* **mark(p)**

1. **p** is a variable-reference that refers to a variable of any pointer-type. This is a variable parameter.

**Mark(p)** causes the pointer **p** to point to the lowest free area in the heap. The next call to **new** will allocate space beginning at the bottom of this area, and then **p** will be a pointer to this space. The pointer **p** is also placed on a stack-like list for subsequent use with the **release** procedure (see below).

### 11.2.4 The Release Procedure

Deallocates all variables in a marked heap area.

*Parameter List:* **release(p)**

1. **p** is a variable-reference that refers to a pointer variable. It must be a pointer that was previously set with the **mark** procedure. The pointer **p** must be on the list created by the **mark** procedure; otherwise an error occurs.

**Release(p)** removes pointers from the list, back to and including the pointer **p**. The heap areas pointed to by these pointers are deallocated. In other words, **release(p)** deallocates all areas allocated since the the pointer **p** was passed to the **mark** procedure.

### 11.2.5 The Memavail Function

Returns the maximum possible amount of available memory.

*Result Type:* longint

*Parameter List:* no parameters

**Memavail** returns the maximum number of words (not bytes) of heap and stack space that could ever be available to the program, allowing for possible automatic expansion of the program's data segment. Note that the result of **memavail** can change over time even if the program does not allocate any heap space, because of activities by the operating system or other processes in the system.



**11.3 Transfer Functions**

The procedures **pack** and **unpack**, described by Jensen and Wirth, are not supported.

**11.3.1 The Trunc Function**

Converts a **real** value to a **longint** value.

*Result Type:* **longint**

*Parameter List:* **trunc(x)**

1. **x** is an expression with a value of type **real**.

**Trunc(x)** returns a **longint** result that is the value of **x** rounded to the largest whole number that is between 0 and **x** (inclusive).

**11.3.2 The Round Function**

Converts a **real** value to a **longint** value.

*Result Type:* **longint**

*Parameter List:* **round(x)**

1. **x** is an expression with a value of type **real**.

**Round(x)** returns a **longint** result that is the value of **x** rounded to the nearest whole number. If **x** is exactly halfway between two whole numbers, the result is the whole number with the greatest absolute magnitude.

**11.3.3 The Ord4 Function**

Converts an ordinal-type or pointer-type value to type **longint**.

*Result Type:* **longint**

*Parameter List:* **ord4(x)**

1. **x** is an expression with a value of ordinal-type or pointer-type.

**Ord4(x)** returns the value of **x**, converted to type **longint**. If **x** is of type **longint**, the result is the same as **x**.

If **x** is of pointer-type, the result is the corresponding physical address, of type **longint**.

If **x** is of type **integer**, the result is the same numerical value represented by **x**, but of type **longint**. This is useful in arithmetic expressions. For example, consider the expression

**abc\*xyz**

where both **abc** and **xyz** are of type **integer**. By the rules given in Section 3.1.1.2, the result of this multiplication is of type **integer** (16 bits). If the mathematical product of **abc** and **xyz** cannot be represented in 16 bits, the result is the low-order 16 bits. To avoid this, the expression can be written as

**ord4(abc)\*xyz**

This expression causes 32-bit arithmetic to be used, and the result is a 32-bit **longint** value.

If **x** is of an ordinal-type other than **integer** or **longint**, the numerical value of the result is the ordinal number determined by mapping the values of the type onto consecutive non-negative integers starting at zero.

#### 11.3.4 The Pointer Function

Converts an **integer** or **longint** value to pointer-type.

*Result Type:* pointer

*Parameter List:* **pointer(x)**

1. **x** is an expression with a value of type **integer** or **longint**.

**Pointer(x)** returns a pointer value that corresponds to the physical address **x**. This pointer is of the same type as **nil** and is assignment-compatible with any pointer-type.

#### 11.4 Arithmetic Functions

In general, any real result returned by an arithmetic function is an approximation. There are two exceptions to this: the result of the **abs** function is exact, and the result of the **pwroften** function is exact when the parameter **n** is in the range  $0 \leq n \leq 10$ .

##### 11.4.1 The Odd Function

Tests whether a whole-number value is odd.

*Result Type:* boolean

*Parameter List:* **odd(x)**

1. **x** is an expression with a value of type **integer** or **longint**.

**Odd(x)** returns **true** if **x** is odd; otherwise it yields **false**.

##### 11.4.2 The Abs Function

Returns the absolute value of a numeric value.

*Result Type:* same as parameter

*Parameter List:* **abs(x)**

1. **x** is an expression with a value of type **real**, **integer**, or **longint**.

**Abs(x)** returns the absolute value of **x**.

### 11.4.3 The Sqr Function

Returns the square of a numeric value.

*Result Type:* depends on parameter (see below)

*Parameter List:* **sqr(x)**

1. **x** is an expression with a value of type **real**, **integer**, or **longint**.

**Sqr(x)** returns the square of **x**. If **x** is of type **real**, the result is **real**; if **x** is of type **longint**, the result is **longint**; and if **x** is of type **integer**, the result may be either **integer** or **longint**.

If **x** is of type **real** and floating-point overflow occurs, the result is  $+\infty$ .

### 11.4.4 The Sin Function

Returns the sine of a numeric value.

*Result Type:* **real**

*Parameter List:* **sin(x)**

1. **x** is an expression with a value of type **real**, **integer**, or **longint**. This value is assumed to represent an angle in radians.

**Sin(x)** returns the sine of **x**. If **x** is infinite, a diagnostic NaN is produced and the invalid operation signal is set (see Appendix D).

### 11.4.5 The Cos Function

Returns the cosine of a numeric value.

*Result Type:* **real**

*Parameter List:* **cos(x)**

1. **x** is an expression with a value of type **real**, **integer**, or **longint**. This value is assumed to represent an angle in radians.

**Cos(x)** returns the cosine of **x**. If **x** is infinite, a diagnostic NaN is produced and the invalid operation signal is set (see Appendix D).

### 11.4.6 The Exp Function

Returns the exponential of a numeric value.

*Result Type:* **real**

*Parameter List:* **exp(x)**

1. **x** is an expression with a value of type **real**, **integer**, or **longint**. All possible values are valid.

**Exp(x)** returns the value of  $e^x$ , where  $e$  is the base of the natural logarithms. If floating-point overflow occurs, the result is  $+\infty$ .

**11.4.7 The Ln Function**

Returns the natural logarithm of a numeric value.

*Result Type:* real

*Parameter List:* ln(x)

1. x is an expression with a value of type **real**, **integer**, or **longint**. All non-negative values are valid; negative values are invalid.

If x is non-negative, **ln(x)** returns the natural logarithm ( $\log_e$ ) of x.

If x is negative, a diagnostic NaN is produced and the Invalid Operation signal is set (see Appendix D).

**11.4.8 The Sqrt Function**

Returns the square root of a numeric value.

*Result Type:* real

*Parameter List:* sqrt(x)

1. x is an expression with a value of type **real**, **integer**, or **longint**. All non-negative values are valid; negative values are invalid.

If x is non-negative, **sqrt(x)** returns the positive square root of x.

If x is negative, a diagnostic NaN is produced and the Invalid Operation signal is set (see Appendix D).

**11.4.9 The Arctan Function**

Returns the arctangent of a numeric value.

*Result Type:* real

*Parameter List:* arctan(x)

1. x is an expression with a value of type **real**, **integer**, or **longint**. All numeric values are valid, including  $\pm\infty$ .

**Arctan(x)** returns the principal value, in radians, of the arctangent of x.

**11.4.10 The Pwroften Function**

Returns a specified power of 10.

*Result Type:* real

*Parameter List:* pwroften(n)

1. n is an expression with a value of type **integer**.

If  $-45 \leq n \leq 38$ , then **pwroften(n)** returns  $10^n$ . The result is mathematically exact for  $0 \leq n \leq 10$ . If  $n \leq -46$ , the result is 0; if  $n \geq 39$ , the result is  $+\infty$ .

## 11.5 Ordinal Functions

### 11.5.1 The Ord Function

Returns the ordinal number of an ordinal-type or pointer-type value.

*Result Type:* integer or longint

*Parameter List:* ord(x)

1. x is an expression with a value of ordinal-type or pointer-type.

If x is of type **integer** or **longint**, the result is the same as x.

If x is of pointer-type, the result is the corresponding physical address, of type **longint**.

If x is of another ordinal-type, the result is the ordinal number determined by mapping the values of the type onto consecutive non-negative whole numbers starting at zero.

For a parameter of type **char**, the result is the corresponding ASCII code. For a parameter of type **boolean**,

ord(false) returns 0

ord(true) returns 1

### 11.5.2 The Chr Function

Returns the **char** value corresponding to a whole-number value.

*Result Type:* char (but see below)

*Parameter List:* chr(x)

1. x is an expression with an **integer** or **longint** value.

**Chr(x)** returns the **char** value whose ordinal number (i.e., its ASCII code) is x, if x is in the range 0..255. If x is not in the range 0..255, the value returned is not within the range of the type **char**, and any attempt to assign it to a variable of type **char** will cause an error.

For any **char** value ch, the following is true:

chr(ord(ch)) = ch

### 11.5.3 The Succ Function

Returns the successor of a value of ordinal-type.

*Result Type:* same as parameter (but see below)

*Parameter List:* succ(x)

1. x is an expression with a value of ordinal-type.

**Succ(x)** returns the successor of x, if such a value exists according to the inherent ordering of values in the type of x.

If  $x$  is the last value in the type of  $x$ , it has no successor. In this case the value returned is not within the range of the type of  $x$ , and any attempt to assign it to a variable of this type will cause unspecified results.

#### 11.5.4 The Pred Function

Returns the predecessor of a value of ordinal-type.

*Result Type:* same as parameter (but see below)

*Parameter List:* `pred(x)`

1.  $x$  is an expression with a value of ordinal-type.

`Pred(x)` returns the predecessor of  $x$ , if such a value exists according to the inherent ordering of values in the type of  $x$ .

If  $x$  is the first value in the type of  $x$ , it has no predecessor. In this case the value returned is not within the range of the type of  $x$ , and any attempt to assign it to a variable of this type will cause unspecified results.

#### 11.6 String Procedures and Functions

The **string** procedures and functions do not accept **packed array of char** parameters, and they do not accept **indexed string** parameters.

##### 11.6.1 The Length Function

Returns the current length of a value of string-type.

*Result Type:* integer

*Parameter List:* `length(str)`

1. `str` is an expression with a value of string-type.

`Length(str)` returns the current length of `str`.

##### 11.6.2 The Pos Function

Searches a string for the first occurrence of a specified substring.

*Result Type:* integer

*Parameter List:* `pos(substr, str)`

1. `substr` is an expression with a value of string-type.
2. `str` is an expression with a value of string-type.

`Pos(substr, str)` searches for `substr` within `str`, and returns an **integer** value that is the index of the first character of `substr` within `str`.

If `substr` is not found, `pos(substr, str)` returns zero.

### 11.6.3 The Concat Function

Takes a sequence of strings and concatenates them.

*Result Type:* string-type

*Parameter List:* `concat(str1 [, str2, ... strn ])`

- Each parameter is an expression with a value of string-type. Any practical number of parameters may be passed.

`Concat(str1, ..., strn)` concatenates all the parameters in the order in which they are written, and returns the concatenated string. Note that the number of characters in the result cannot exceed 255.

### 11.6.4 The Copy Function

Returns a substring of specified length, taken from a specified position within a string.

*Result Type:* string-type

*Parameter List:* `copy(source, index, count)`

1. `source` is an expression with a value of string-type.
2. `index` is an expression with an integer value.
3. `count` is an expression with an integer value.

`Copy(source, index, count)` returns a string containing `count` characters from `source`, beginning at `source[index]`.

### 11.6.5 The Delete Procedure

Deletes a substring of specified length from a specified position within the value of a string variable.

*Parameter List:* `delete(dest, index, count)`

1. `dest` is a variable-reference that refers to a variable of string-type. This is a variable parameter.
2. `index` is an expression with an integer value.
3. `count` is an expression with an integer value.

`Delete(dest, index, count)` removes `count` characters from the value of `dest`, beginning at `dest[index]`.

### 11.6.6 The Insert Procedure

Inserts a substring into the value of a string variable, at a specified position.

*Parameter List:* `insert(source, dest, index)`

1. `source` is an expression with a value of string-type.
2. `dest` is a variable-reference that refers to a variable of string-type. This is a variable parameter.
3. `index` is an expression with an integer value.

**Insert(source, dest, index)** inserts **source** into **dest**. The first character of **source** becomes **dest[index]**.

### 11.7 Byte-Oriented Procedures and Functions

These features allow a program to treat a program variable as a sequence of bytes, without regard to data types.

---

#### NOTE

The **sizeof** function (described in Section 11.7.3, below) can be used to determine the number of bytes in a variable.

---

These procedures do no type-checking on their **source** or **dest** actual-parameters. However, since these are variable parameters they *cannot be indexed* if they are packed or if they are of string-type. If an unpacked "byte array" is desired, then a variable of the type

**array [10..hi] of -128..127**

should be used for **source** or **dest**. The elements in an array of this type are stored in contiguous bytes, and, since it is unpacked, an array of this type can be used with an index as an actual-parameter for these routines.

---

#### IMPLEMENTATION NOTE

Currently, an array with elements of the type **0..255** or the type **char** has its elements stored in words, not bytes.

---

#### 11.7.1 The Moveleft Procedure

Copies a specified number of contiguous bytes from a *source range* to a *destination range* (starting at the lowest address).

*Parameter List:* **moveleft(source, dest, count)**

1. **source** is a variable-reference that refers to a variable of any type except a file-type or a structured-type that contains a file-type. This is a variable parameter. The first byte allocated to **source** (lowest address within **source**) is the first byte of the source range.
2. **dest** is a variable-reference that refers to a variable of any type except a file-type or a structured-type that contains a file-type. This is a variable parameter. The first byte allocated to **dest** (lowest address within **dest**) is the first byte of the destination range.
3. **count** is an expression with an integer value. The source range and the destination range are each **count** bytes long.

**Moveleft(source, dest, count)** copies **count** bytes from the source range to the destination range.



**Moveleft** starts from the "left" end of the source range (lowest address). It proceeds to the "right" (higher addresses), copying bytes into the destination range, starting at the lowest address of the destination range.

The **count** parameter is not range-checked.

### 11.7.2 The Moveright Procedure

**Moveright** is exactly like **moveleft** (see above), except that it starts from the "right" end of the source range (highest address). It proceeds to the "left" (lower addresses), copying bytes into the destination range, starting at the highest address of the destination range.

The reason for having both **moveleft** and **moveright** is that the **source** and **destination** ranges may overlap. If they overlap, the order in which bytes are moved is critical: each byte must be moved before it gets overwritten by another byte.

### 11.7.3 The Sizeof Function

Returns the number of bytes occupied by a specified variable, or by any variable of a specified type.

*Result Type:* integer

*Parameter List:* **sizeof(id)**

1. **id** is either a variable-identifier or a type-identifier. It must not refer to a file-type or a structured-type that contains a file-type, or to a variable of such a type.

**Sizeof(id)** returns the number of bytes occupied by **id**, if **id** is a variable-identifier; if **id** is a type-identifier, it returns the number of bytes occupied by any variable of type **id**.

## 11.8 Packed Array of Char Procedures and Functions

---

### NOTE

---

These routines operate only on **packed arrays of char**. The **packed arrays of char** cannot be subscripted; the operations always begin at the first character in a **packed array of char**.

---

### 11.8.1 The Scaneq Function

Searches a **packed array of char** for the first occurrence of a specified character.

*Result Type:* integer

*Parameter List:* **scaneq(limit, ch, paoc)**

1. **limit** is an expression with a value of type **integer** or **longint**. It is truncated to 16 bits, and is not range-checked.
2. **ch** is an expression with a value of type **char**.

3. **paoc** is an expression with a value of type **packed array of char**. This is a variable parameter.

**Scaneq(limit, ch, paoc)** scans **paoc**, looking for the first occurrence of **ch**. The scan begins with the first character in **paoc**. If the character is not found within **limit** characters from the beginning of **paoc**, the value returned is equal to **limit**. Otherwise, the value returned is the number of characters scanned before **ch** was found.

#### 11.8.2 The Scanne Function

This function is exactly like **scaneq**, except that it searches for a character that does *not* match the **ch** parameter.

#### 11.8.3 The Fillchar Procedure

Fills a specified number of characters in a **packed array of char** with a specified character.

*Parameter List:* **fillchar(paoc, count, ch)**

1. **paoc** is an expression with a value of type **packed array of char**. This is a variable parameter.
2. **count** is an expression with a value of type **integer** or **longint**. It is truncated to 16 bits, and is not range-checked.
3. **ch** is an expression with a value of type **char**.

**Fillchar(paoc, count, ch)** writes the value of **ch** into **count** contiguous bytes of memory, starting at the first byte of **paoc**.

Since the **count** parameter is not range-checked, it is possible to write into memory outside of **paoc**, with unspecified results.



# Chapter 12

## The Compiler

12.1	Compiler Commands .....	12-1
12.2	Conditional Compilation.....	12-3
12.2.1	Compile-Time Variables and the \$DECL Command.....	12-3
12.2.2	The \$SETC Command .....	12-4
12.2.3	Compile-Time Expressions .....	12-4
12.2.4	The \$IFC, \$ELSEC, and \$ENDC Commands .....	12-4
12.3	Optimization of If-Statements .....	12-5
12.4	Optimization of While-Statements and Repeat-Statements .....	12-7
12.5	Efficiency of Case-Statements .....	12-7



# The Compiler

The Pascal compiler translates Pascal source text to an intermediate code, and the code generator translates the intermediate code to MC68000 object code. Instructions for operating the compiler and code generator are given in the *Workshop User's Guide for the Lisa*.

## 12.1 Compiler Commands

A compiler command is a text construction, embedded in source text, that controls compiler operation. Every compiler command is written within comment delimiters, [...] or (\*...\*). Every compiler command begins with the \$ character, which must be the first character inside the comment delimiters.

In this manual, compiler commands are shown in upper case to help distinguish them from Pascal program text; however, upper and lower case are interchangeable in compiler commands just as they are in Pascal program text.

The following compiler commands are available:

### INPUT FILE CONTROL

---

- \$I filename** Start taking source code from file *filename*. When the end of this file is reached, revert to the previous source file. If the filename begins with + or -, there must be a space between \$I and the filename (the space is not necessary otherwise).
- \$U filename** Search the file *filename* for any units subsequently specified in the uses-clause. Does not apply to intrinsic units.

### CONTROL OF CODE GENERATION

---

- \$C+ or \$C-** Turn code generation on (+) or off (-). This is done on a procedure-by-procedure basis. These commands should be written between procedures; results are unspecified if they are written inside procedures. The default is \$C+.
- \$OV+ or \$OV-** Turn integer overflow checking on (+) or off (-). Overflow checking is done after all integer add, subtract, 16-bit multiply, divide, negate, abs, and 16-bit square operations, and after 32 to 16 bit conversions. The default is \$OV-.
- \$R+ or \$R-** Turn range checking on (+) or off (-). At present, range checking is done in assignment statements and array indexes and for string value parameters. No range checking is done for type *longint*. The default is \$R+.

- \$S segname** Start putting code modules into segment *segname*. The default segment name is a string of blanks to designate the "blank segment," in which the main program and all built-in support code are always linked. All other code can be placed into any segment.
- \$X+ or \$X-** Turn automatic run-time stack expansion on (+) or off (-). The default is **\$X+**.

---

**NOTE**

Compiler directives that affect code generation take effect when the end of the Pascal statement in which they are embedded is reached. If the same directive is specified more than once in a statement, the last setting is used. A tricky case of this is:

```
begin
  j := foo;
  {$R-}
  i := i*2
  {$R+}
end
```

Since the second assignment does not end with a semicolon, and actually ends when the **end** is encountered, range checking will not be turned off for that statement.

---

***DEBUGGING***

---

- \$D+ or \$D-** Turn the generation of procedure names in object code on (+) or off (-). These commands should be written between procedures; results are unspecified if they are written inside procedures. The default is **\$D+**.

***CONDITIONAL COMPILATION***

---

- \$DECL list** (see Section 12.2 below).
- \$ELSEC** (see Section 12.2 below).
- \$ENDC** (see Section 12.2 below).
- \$IFC** (see Section 12.2 below).
- \$SETC** (see Section 12.2 below).

LISTING CONTROL

---

<b>\$E filename</b>	Start making a listing of compiler errors as they are encountered. Analogous to <b>\$L filename</b> (see below). The default is no error listing.
<b>\$L filename</b>	Start listing the compilation on file <b>filename</b> . If a listing is being made already, that file is closed and saved prior to opening the new file. The default is no listing. If the filename begins with + or -, there must be a space between <b>\$L</b> and the filename (the space is not necessary otherwise).
<b>\$L+ or \$L-</b>	The first + or - following the <b>\$L</b> turns the source listing on (+) or off (-) without changing the list file. You must specify the listing file before using <b>\$L+</b> . The default is <b>\$L+</b> , but no listing is produced if no listing file has been specified.

**12.2 Conditional Compilation**

Conditional compilation is controlled by the **\$IFC**, **\$ELSEC**, and **\$ENDC** commands, which are used to bracket sections of source text. Whether a particular bracketed section of a program is compiled depends on the **boolean** value of a *compile-time expression*, which can contain *compile-time variables*.

**12.2.1 Compile-Time Variables and the \$DECL Command**

Compile-time variables are completely independent of program variables; even if a compile-time variable and a program variable have the same identifier, they can never be confused by the compiler.

A compile-time variable is declared when it appears in the identifier-list of a **\$DECL** command.

*Example of compile-time variable declaration:*

```
{ $DECL LIBVERSION, PROGVERSION }
```

This declares **LIBVERSION** and **PROGVERSION** as compile-time variables. Notice that no types are specified.

Note the following points about compile-time variables:

- Compile-time variables have no types, although their values do. The only possible types are **integer** and **boolean**.
- All compile-time variables should be declared before the end of the variable-declaration-part of the main program. In other words a **\$DECL** command that declares a new compile-time variable must precede the main program's procedure and function declarations (if any). The new compile-time variable is then known throughout the remainder of the compilation.
- At any point in the program, a compile-time variable can have a new value assigned to it by a **\$SETC** command.



### 12.2.2 The \$SETC Command

The \$SETC command has the form

```
{ $SETC ID := EXPR }
```

*or*

```
{ $SETC ID = EXPR }
```

where ID is the identifier of a compile-time variable and EXPR is a compile-time expression. EXPR is evaluated immediately. The value of EXPR is assigned to ID.

*Example of assignment to compile-time variable:*

```
{ $SETC LIBVERSION := 5 }
```

This assigns the value 5 to the compile-time variable LIBVERSION.

### 12.2.3 Compile-Time Expressions

Compile-time expressions appear in the \$SETC command and in the \$IFC command. A compile-time expression is evaluated by the compiler as soon as it is encountered in the text.

The only operands allowed in a compile-time expression are:

- Compile-time variables
- Constants of the types **integer** and **boolean**. (These are also the only possible types for results of compile-time expressions.)

All Pascal operators are allowed except as follows:

- The **in** operator is not allowed.
- The **@** operator is not allowed.
- The **/** operator is automatically replaced by **div**.

### 12.2.4 The \$IFC, \$ELSEC, and \$ENDC Commands

The \$ELSEC and \$ENDC commands take no arguments. The \$IFC command has the form

```
{ $IFC EXPR }
```

where EXPR is a compile-time expression with a **boolean** value.

These three commands form constructions similar to the Pascal if-statement, except that the \$ENDC command is always needed at the end of the \$IFC construction. \$ELSEC is optional.

*Example of conditionally compiled code:*

```
{$IFC PROGVERSION >= LIBVERSION}
  k := kval1(data+indat);
{$ELSEC}
  k := kval2(data+cpindat);
{$ENDC}
writeln(k)
```

If the value of **PROGVERSION** is greater than or equal to the value of **LIBVERSION**, then the statement `k:=kval1(data+indat)` is compiled, and the statement `k:=kval2(data+cpindat)` is skipped.

But if the value of **PROGVERSION** is less than the value of **LIBVERSION**, then the first statement is skipped and the second statement is compiled.

In either case, the `writeln(k)` statement is compiled because the conditional construction ends with the **\$ENDC** command.

**\$IFC** constructions can be nested within each other to 10 levels. Every **\$IFC** must have a matching **\$ENDC**.

When the compiler is skipping, all commands in the skipped text are ignored except the following:

```
$ELSEC
$ENDC
$IFC      (so that $ENDC's can be matched properly)
```

All program text is ignored during skipping. If a listing is produced, each source line that is skipped is marked with the letter S as its "lex level."

### 12.3 Optimization of If-Statements

When the compiler finds an if-statement controlled by a **boolean** constant, it may be unnecessary to compile the **then** part or the **else** part. For example, given the declarations

```
const always = true;
      never  = false;
```

then the statement

```
if never then statement
```

will not be compiled at all. In the statement

```
if never then statement1
   else statement2
```

"statement1" is not compiled; only "statement2" is compiled.

Similarly, in the statement

```
    if always then statement1
      else statement2
```

only "statement1" is compiled.

The interaction between this optimization and conditional compilation can be seen from the following program:

```
program Foo;
  {$SETC FLAG := FALSE}
  const pi = 3.1415926;
        size = 512;
  {$IFC FLAG}
    debug = false; {a boolean constant, if FLAG=true}
  {$ENDC}
  var i, j, k, l, m, n: integer;
  {$IFC NOT FLAG}
    debug: boolean; {a boolean variable, if FLAG=false}
  {$ENDC}
  ...
  {$IFC NOT FLAG}
  procedure whatmode;
  begin
    {interactive procedure to set global boolean variable, debug}
  end;
  {$ENDC}
  ...
  begin {main}
  {$IFC NOT FLAG}
    whatmode;
  {$ENDC}
  ...
    if debug then begin
      statement1
    end
    else begin
      statement2
    end
  ...
end.
```

The way this is compiled depends on the compile-time variable FLAG. If FLAG is false, then `debug` is a *boolean variable* and the `whatmode` procedure is compiled and called at the beginning of the main program. The `if debug`

statement is controlled by a **boolean** variable and all of it is compiled, in the usual manner.

But if the value of **FLAG** is changed to **true**, then **debug** is a *constant* with the value **false**, and **whatmode** is neither compiled nor called. The **if debug** statement is controlled by a constant, so only its **else** part, "statement2", is compiled.

#### 12.4 Optimization of While-Statements and Repeat-Statements

A while-statement or repeat-statement controlled by a **boolean** constant does not generate any conditional branches.

#### 12.5 Efficiency of Case-Statements

A sparse or small case-statement will generate smaller and faster code than the corresponding sequence of if-statements.



# Appendixes

A	Comparison to Apple II and Apple III Pascal .....	A-1
B	Known Anomalies in the Compiler .....	B-1
C	Syntax of the Language .....	C-1
D	Floating-Point Arithmetic .....	D-1
E	QuickDraw .....	E-1
F	Hardware Interface .....	F-1
G	Lisa Extended Character Set .....	G-1
H	Error Messages .....	H-1
I	Pascal Workshop Files .....	I-1
J	Listing Formats .....	J-1



# Appendix A

## Comparison to Apple II and Apple III Pascal

A.1 Extensions .....	A-1
A.2 Deletions .....	A-1
A.3 Other Differences .....	A-3
A.4 Predefined Identifiers .....	A-4





# Comparison to Apple II and Apple III Pascal

This appendix contains lists of the major differences between the Pascal language on the Lisa and the Pascal implemented on the Apple II and Apple III. Please note that these lists are not exhaustive.

## A.1 Extensions

The following features have been added on the Lisa:

- **@ Operator**—returns the pointer to its operand (see Section 5.1.6).
- **Heapresult**, **pointer**, and **ord4** functions (see Sections 11.2.2, 11.3.3, and 11.3.4).
- **Keypress** function built into the language, with same effect as the **keypress** function in the **applestuff** unit of Apple II and Apple III Pascal (see Section 10.3.7.1).
- Hexadecimal constants (see Section 1.4).
- **Otherwise**-clause in case-statement (same as Apple III Pascal; see Section 6.2.2.2).
- Global goto-statement (see Section 6.1.3).
- A **file of char** type that is distinct from the **text** type (see Sections 3.2.4 and 10.3).
- Numerous compiler commands (see Section 12.1).
- Procedural and functional parameters (see Sections 7.3.3 and 7.3.4).
- Stronger type-checking (see Sections 3.4 and 7.3.5).

## A.2 Deletions

The following features are not included on the Lisa:

- **Turtlegraphics**, **applestuff**, and other standard units of Apple II and Apple III Pascal.
- **Interactive** type (not needed, as the I/O procedures will do the right thing with a file of type **text** if it is opened on a character device).
- **Keyboard** file—same effect can be obtained by opening a file of type **text** on the device **-KEYBOARD** (see Section 10.3).
- Unit (device-oriented) I/O procedures.

- Recognition of the ETX character (control-C) to mean "end of file" in input from a character device.
- "Long integer" data type, with length attribute in declaration. Replaced by the **longint** type (see Section 3.1.1.2).
- "Initialization" code in a unit (see Section 9).
- The ability to create new intrinsic-units and install them in the system (see Section 9).
- **Reset** procedure without an external file title, for use on a file that is already open (see Section 10.1.1). To obtain the same effect, close the file and reopen it.
- **Treesearch**.
- **Bytestream**, **wordstream** (data types in Apple III Pascal).
- **Exit(program)**—The **exit(identifier)** form works, and the identifier can be the program-identifier. **Halt** can also be used for orderly exit from a program (see Section 11.1).
- Extended comparisons (see Section 5.1.5).
- **Scan** function. Replaced by **scaneq** and **scanne** (see Section 11.8).
- Bit-wise **boolean** operations.
- **Segment** keyword for procedures and functions. Use the **\$S** command instead (see Section 12.1).
- The following compiler commands (see Section 12.1):
  - **\$I+** and **\$I-** (no automatic I/O checking; program must use **ioresult** function).
  - **\$G** (**\$G+** is the assumption on the Lisa).
  - **\$N** and **\$R** (for resident code segments).
  - **\$Q**.
  - **\$S+** and **\$S++** for swapping.
  - **\$U+** and **\$U-** (for User Program).
  - **\$V**.

In general, do not assume that a compiler command used in Apple II or Apple III Pascal is valid on the Lisa. Furthermore, do not assume that an Apple II or Apple III Pascal compiler command is "harmless" on the Lisa, as it may be implemented with a different meaning.

### A.3 Other Differences

The following features of Pascal on the Lisa are different from the corresponding features of Apple II and Apple III Pascal:

- Size of all strings must be explicitly declared (see Section 3.1.1.6).
- **Mod** and **div**--Pascal on the Lisa truncates toward 0 (see Section 5.1.2).
- Apple II and Apple III Pascal ignore underscores; Pascal on the Lisa does not. They are legal characters in identifiers (see Section 1.2).
- A **goto**-statement cannot refer to a case-constant in Pascal on the Lisa (see Section 6.1.3).
- A program must begin with the word **program** in Pascal on the Lisa (see Chapter 8).
- **Trunc** is different (see Section 11.3.1).
- **Write(b)** where **b** is a **boolean** will write either 'TRUE' or 'FALSE' in Pascal on the Lisa (see Section 10.3.3).
- Whether a file is a textfile does not depend on whether its name ends with ".TEXT" when it is created. Instead, any external file opened with a file variable of type **text** is treated as a textfile, while a file opened with a file variable of type **file of char** is not; it is treated as a "datafile," i.e. a straight file of records which are of type **char** (see Sections 3.2.4 and 10.2).
- **Get**, **put**, and the contents of the file buffer variable are not supported on files of type **text**. Use only the text-oriented I/O procedures with textfiles.
- **Eoln** and **eof** functions on files of type **text** work as they do on **interactive** files in Apple II and Apple III Pascal.
- Pascal on the Lisa does not let you pass an element of a packed variable as a variable parameter (see Sections 7.3.2, 11.7, and 11.8).
- Limits on sets are different (see Section 3.2.3).
- The control variable of a **for**-statement must be a local variable (see Section 6.2.3.3).
- In a **write** or **writeln** call, the default field lengths for **integer** and **real** values are 8 and 12 respectively (see Section 10.3.3).

### A.4 Predefined Identifiers

The predefined identifiers listed in Table A-1 are built into the Pascal Compiler for each machine, as indicated. If you declare or define these names in your program, no Compiler error will result, but you will lose the capacity of the corresponding built-in, or predefined, entity. The list does not include identifiers in special library units, such as those in the QuickDraw graphics unit.

**Table A-1**  
**Predefined Identifiers**  
**in the Lisa Pascal Compiler**

<u>Identifier</u>	<u>Type</u>	<u>Lisa</u>	<u>Apple III</u>	<u>Apple II</u>
ABS	Generic function	Yes	Yes	Yes
BLOCKREAD	Integer function	Yes	Yes	Yes
BLOCKWRITE	Integer function	Yes	Yes	Yes
BOOLEAN	Type	Yes	Yes	Yes
BYTESTREAM	Type	No	Yes	No
CHAR	Type	Yes	Yes	Yes
CHR	Character function	Yes	Yes	Yes
CLOSE	Procedure	Yes	Yes	Yes
CONCAT	String function	Yes	Yes	Yes
COPY	String function	Yes	Yes	Yes
DELETE	Procedure	Yes	Yes	Yes
EOF	Boolean function	Yes	Yes	Yes
EOLN	Boolean function	Yes	Yes	Yes
EXIT	Procedure	Different	Yes	Yes
EXP	Real function	Yes	Yes	Yes
FALSE	Constant	Yes	Yes	Yes
FILLCHAR	Procedure	Different	Yes	Yes
GET	Procedure	Yes	Yes	Yes
GOTOXY	Procedure	Yes	Yes	Yes
HALT	Procedure	Yes	Yes	Yes
HEAPRESULT	Integer function	Yes	No	No
IDSEARCH	Procedure	No	Yes	Yes
INCLASS	Boolean function	Yes	No	No
INPUT	File	Yes	Yes	Yes
INSERT	Procedure	Yes	Yes	Yes
INTEGER	Type	Yes	Yes	Yes
INTERACTIVE	Type	Yes	Yes	Yes

<u>Identifier</u>	<u>Type</u>	<u>Lisa</u>	<u>Apple III</u>	<u>Apple II</u>
IORESULT	Integer function	Yes	Yes	Yes
KEYBOARD	File	Device	Yes	Yes
KEYPRESS	Boolean function	In library	Yes	Yes
LENGTH	Integer function	Yes	Yes	Yes
LN	Real function	Yes	Yes	Yes
LOG	Real function	No	Yes	Yes
LONGINT	Type	Yes	No	No
MARK	Procedure	Different	Yes	Yes
MAXINT	Constant	Yes	Yes	Yes
MEMAVAIL	Integer function	Different	Yes	Yes
MOVELEFT	Procedure	Different	Yes	Yes
MOVERIGHT	Procedure	Different	Yes	Yes
NEW	Procedure	Different	Yes	Yes
ODD	Boolean function	Yes	Yes	Yes
ORD	Integer function	Yes	Yes	Yes
ORD4	Integer function	Yes	No	No
OUTPUT	File	Yes	Yes	Yes
PAGE	Procedure	Yes	Yes	Yes
POINTER	Pointer function	Yes	No	No
POS	Integer function	Yes	Yes	Yes
PRED	Integer function	Yes	Yes	Yes
PUT	Procedure	Yes	Yes	Yes
PWROFTEN	Real function	Yes	Yes	Yes
READ	Procedure	Yes	Yes	Yes
READLN	Procedure	Yes	Yes	Yes
REAL	Type	Yes	Yes	Yes
RELEASE	Procedure	Different	Yes	Yes
RESET	Procedure	Different	Yes	Yes
REWRITE	Procedure	Yes	Yes	Yes
ROUND	Integer function	Yes	Yes	Yes

<u>Identifier</u>	<u>Type</u>	<u>Lisa</u>	<u>Apple III</u>	<u>Apple II</u>
SCAN	Integer function	No	Yes	Yes
SCANEQ	Integer function	Yes	No	No
SCANNE	Integer function	Yes	No	No
SEEK	Procedure	Yes	Yes	Yes
SIZEOF	Integer function	Yes	Yes	Yes
SQR	Generic function	Yes	Yes	Yes
SQRT	Real function	Yes	Yes	Yes
STR	String function	No	Yes	Yes
STRING	Type function	Length req	Yes	Yes
SUCC	Integer function	Yes	Yes	Yes
TEXT	Type function	Different	Yes	Yes
THISCLASS	Pointer function	Yes	No	No
TREESEARCH	Integer function	No	Yes	Yes
TRUE	Constant	Yes	Yes	Yes
TRUNC	Integer function	Yes	Yes	Yes
UNITBUSY	Boolean function	No	Yes	Yes
UNITCLEAR	Procedure	No	Yes	Yes
UNITREAD	Procedure	No	Yes	Yes
UNITSTATUS	Procedure	No	Yes	No
UNITWAIT	Procedure	No	Yes	Yes
UNITWRITE	Procedure	No	Yes	Yes
WORDSTREAM	Type	No	Yes	No
WRITE	Procedure	Yes	Yes	Yes
WRITELN	Procedure	Yes	Yes	Yes

## Appendix B

### Known Anomalies in the Compiler

This appendix describes the known anomalies in the current implementation of the compiler.

#### B.1 Scope of Declared Constants

Consider the following program:

```
program cscope1;
  const ten=10;
  procedure p;
    const ten=ten;  {THIS SHOULD BE AN ERROR}
    begin
      writeln(ten)
    end;
begin
  p
end.
```

The constant declaration in procedure `p` should cause a compiler error, because it is illegal to use an identifier within its own declaration (except for pointer identifiers). However, the error is not detected by the compiler. The effect is that the value of the global constant `ten` is used in defining the local constant `ten`, and the `writeln` statement writes "10".

A more serious anomaly of the same kind is illustrated by the following program:

```
program cscope2;
  const red=1; violet=2;
  procedure q;
    type arrayType=array[red..violet] of integer;
      color=(violet, blue, green, yellow, orange, red);
    var arrayVar:arrayType; c:color;
    begin
      arrayVar[1]:=1;
      c:=red;
      writeln(ord(c))
    end;
begin
  q
end.
```



Within the procedure `q`, the global constants `red` and `violet` are used to define an array index type; the effect of `array[red..violet]` is equivalent to `array[1..2]`. In the declaration of the type `color`, the constants `red` and `violet` are locally redefined; they are no longer equal to 1 and 2 respectively--instead they are constants of type `color` with ordinalities 5 and 0 respectively. The `writeln` statement writes "5".

The use of `red` in the declaration of the type `color` should cause a compiler error but does not.

Consider the statement

```
arrayVar[1]:=1;
```

If this statement is replaced by

```
arrayVar[red]:=1;
```

a compiler error will result, as `red` is now an illegal index value for `arrayVar`--even though `arrayVar` is of type `arrayType` and `arrayType` is defined by `array[red..violet]`.

To avoid this kind of situation, avoid redefinition of constant-identifiers in enumerated scalar types.

## B.2 Scope of Base-Types for Pointers

Consider the following program:

```
program pscope1;
  type s=0..7;
  procedure makecurrent;
    type sptr= s;
    s=record
      ch:char;
      bool:boolean
    end;
  var current:s;
      ptrs:sptr;
  begin
    new(ptrs);
    ptrs :=current
  end;
begin
  makecurrent
end.
```

Here we have a global type `s`, which is a subrange of `integer`; we also have a local type `s`, which is a record-type. Within the procedure `makecurrent`, the type `sptr` is defined as a pointer to a variable of type `s`. The intention is that this should refer to the local type `s`, defined on the next line of the program; unfortunately, however, the compiler does not yet know about the local type `s`

and uses the global type *s*. Thus *ptrs* becomes a pointer to a variable of type 0..7 instead of a pointer to a record. Consequently the statement

```
ptrs^ := current
```

causes a compiler error since *ptrs<sup>^</sup>* and *current* are of incompatible types.

To avoid this kind of situation, re-declare the type *s* locally before declaring the pointer-type *sptr* based on *s*. Alternately, avoid re-declaration of identifiers that are used as base-types for pointer-types.



# Appendix C

## Syntax of the Language

C.1 Tokens and Constants .....	C-1
C.2 Blocks .....	C-4
C.3 Data Types .....	C-5
C.4 Variables .....	C-9
C.5 Expressions .....	C-10
C.6 Statements .....	C-12
C.7 Procedures and Functions .....	C-15
C.8 Programs .....	C-16
C.9 Units .....	C-17



# Syntax of the Language

This appendix collects the syntax diagrams found in the main sections of this manual. See the Preface for an introduction to syntax diagrams.

## C.1 Tokens and Constants (see Chapter 1)

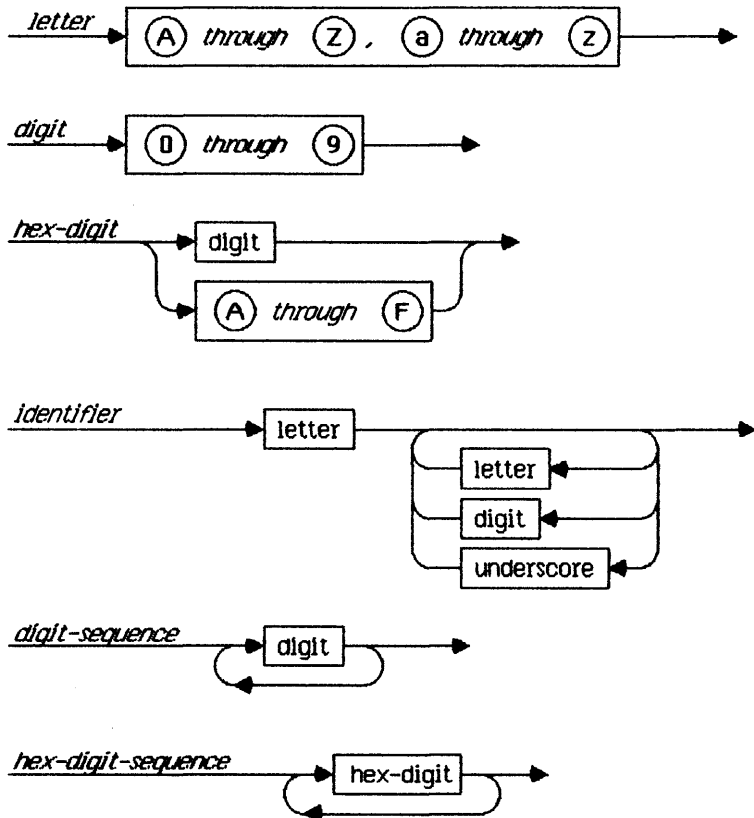

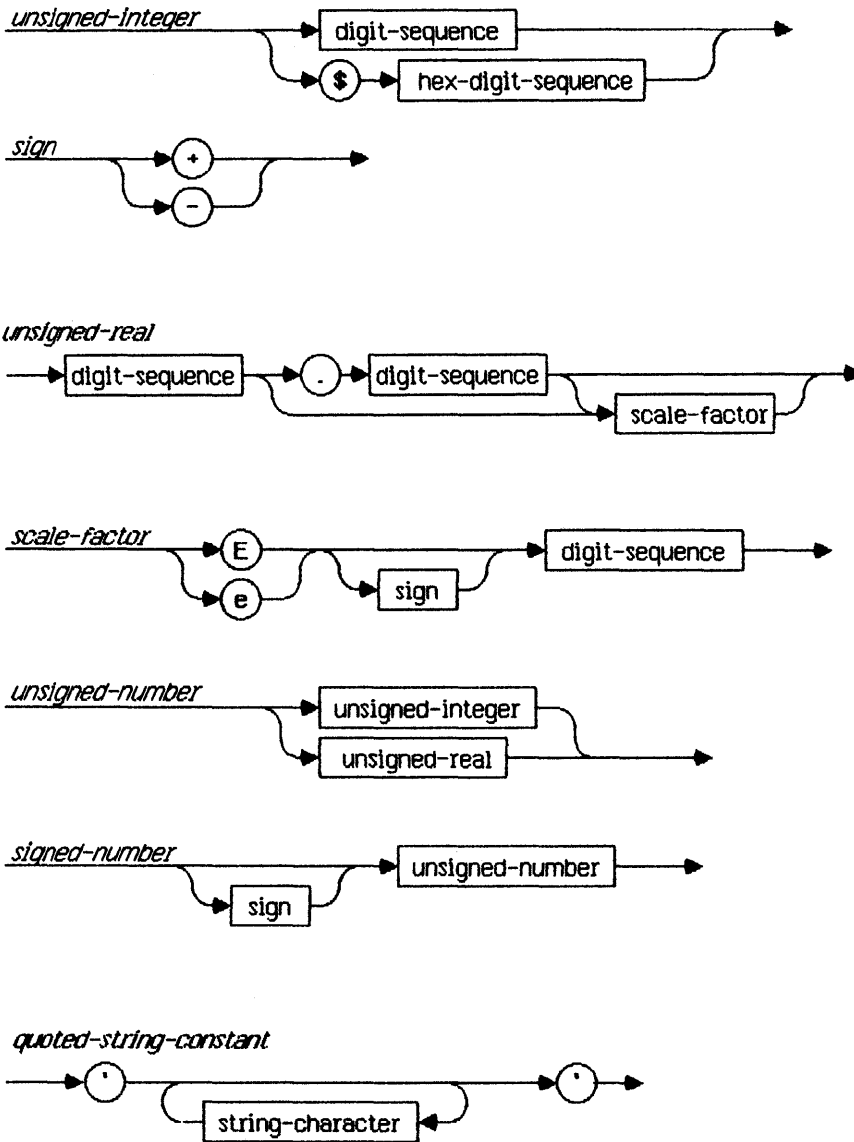

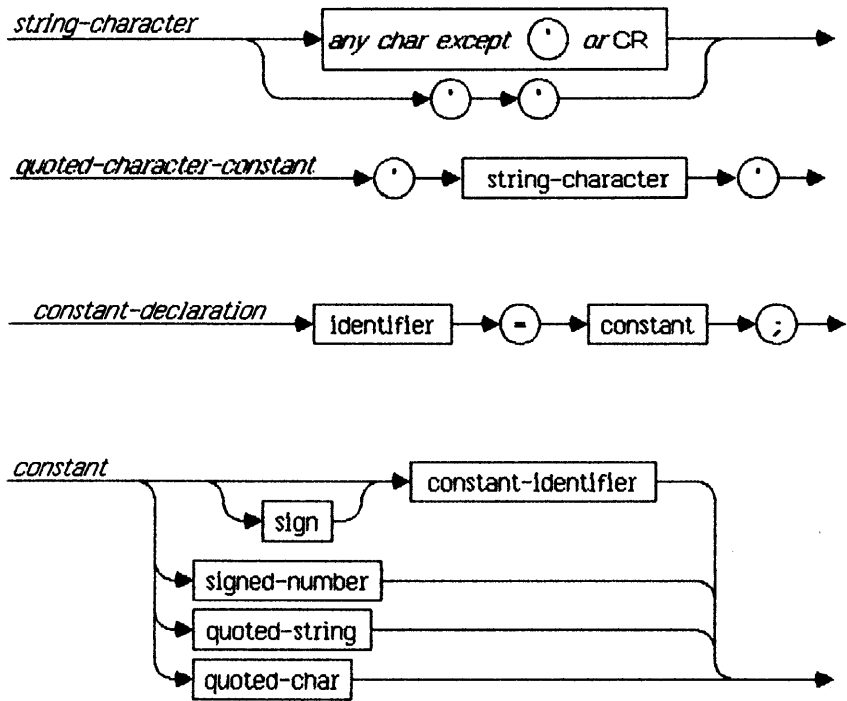



C.2 Blocks (see Chapter 2)

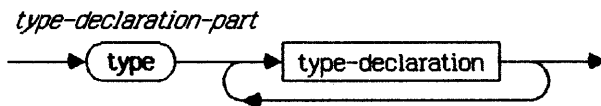
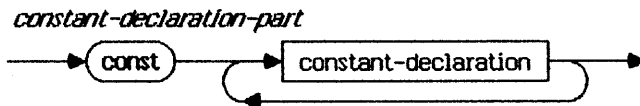
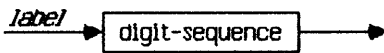
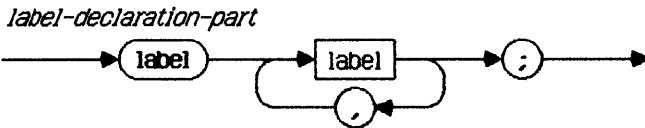
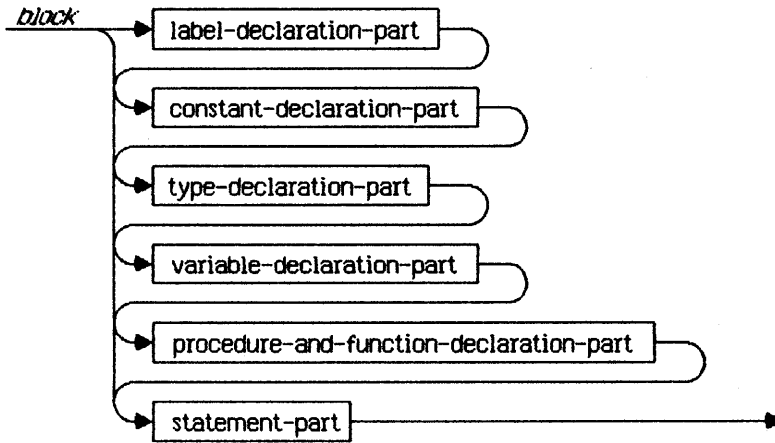

*variable-declaration-part*

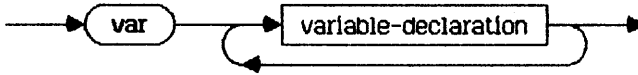

*procedure-and-function-declaration-part*

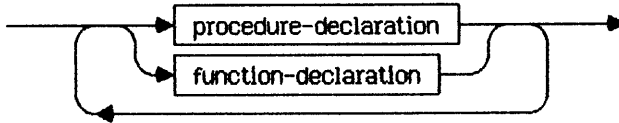

*statement-part*



### C.3 Data Types (see Chapter 3)

*type-declaration*

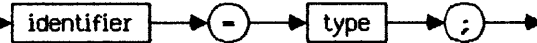

*type*

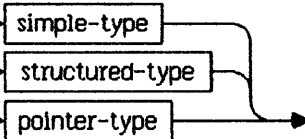

*simple-type*

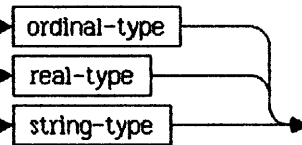

*real-type*

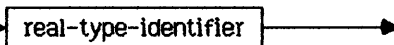

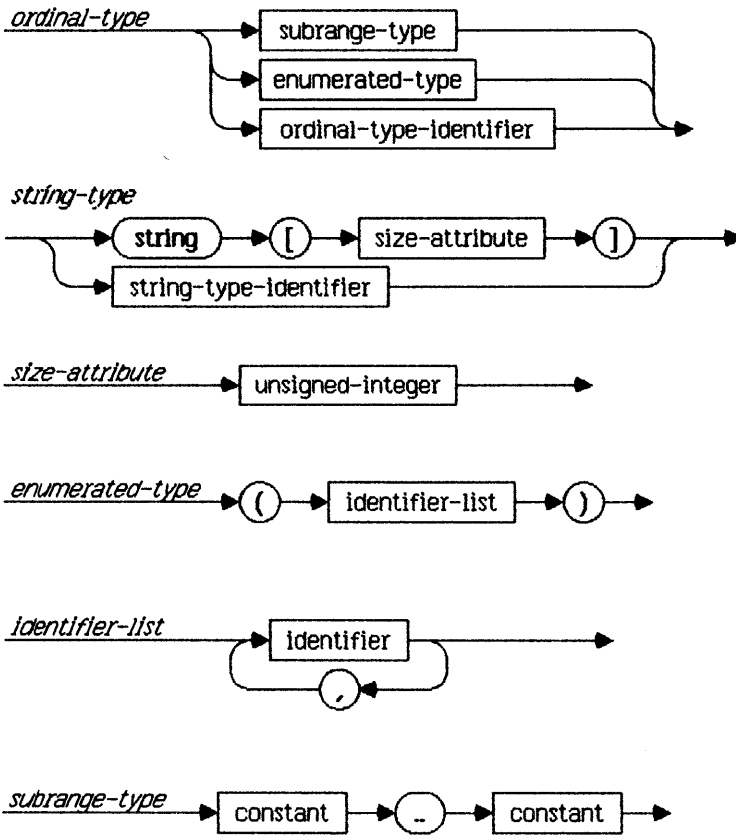

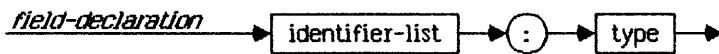
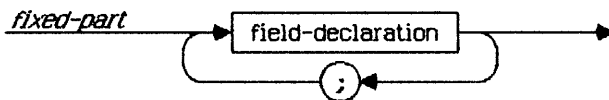
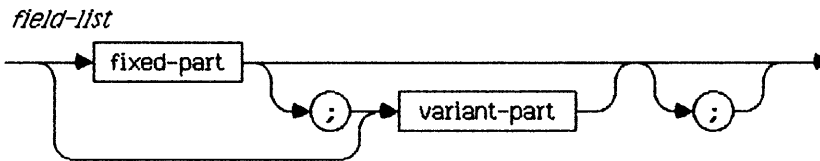
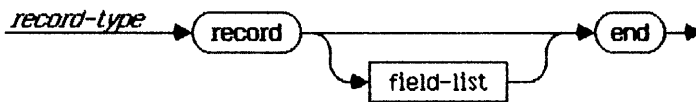
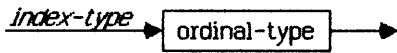
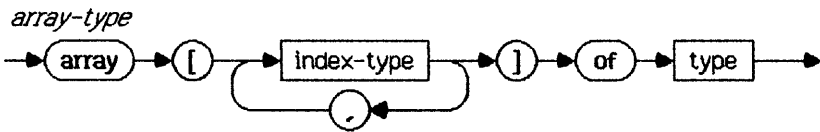
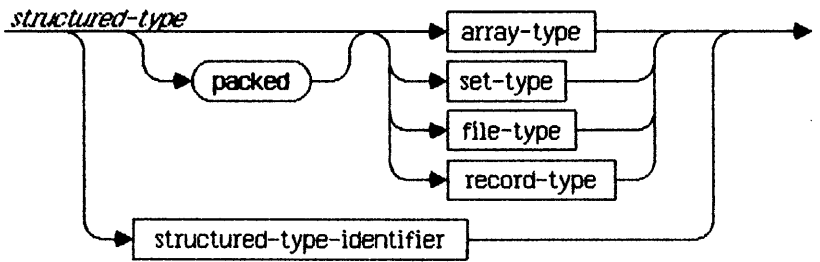

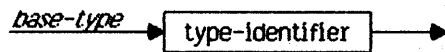
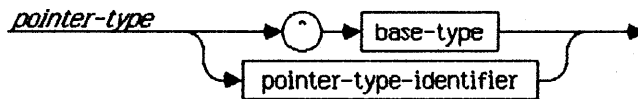
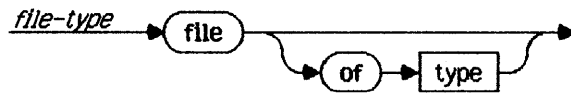
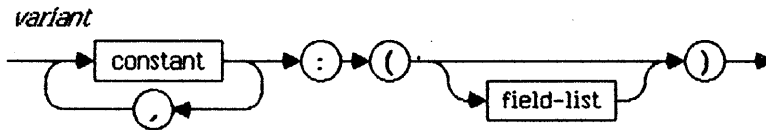
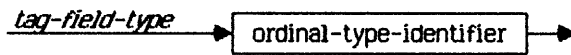
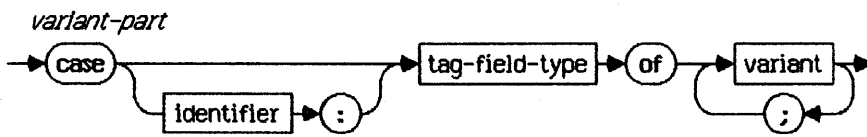

C.4 Variables (see Chapter 4)

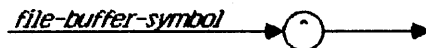
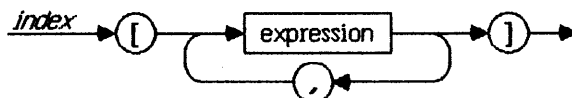
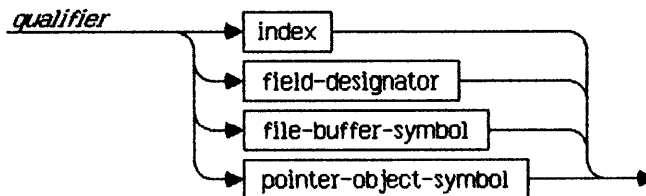
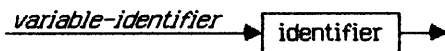
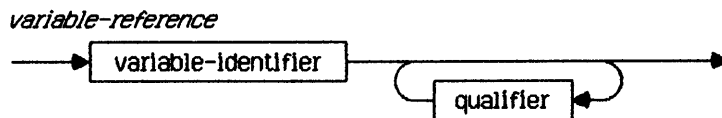
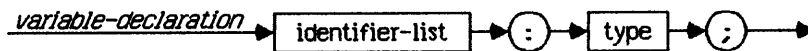

C.5 Expressions (see Chapter 5)

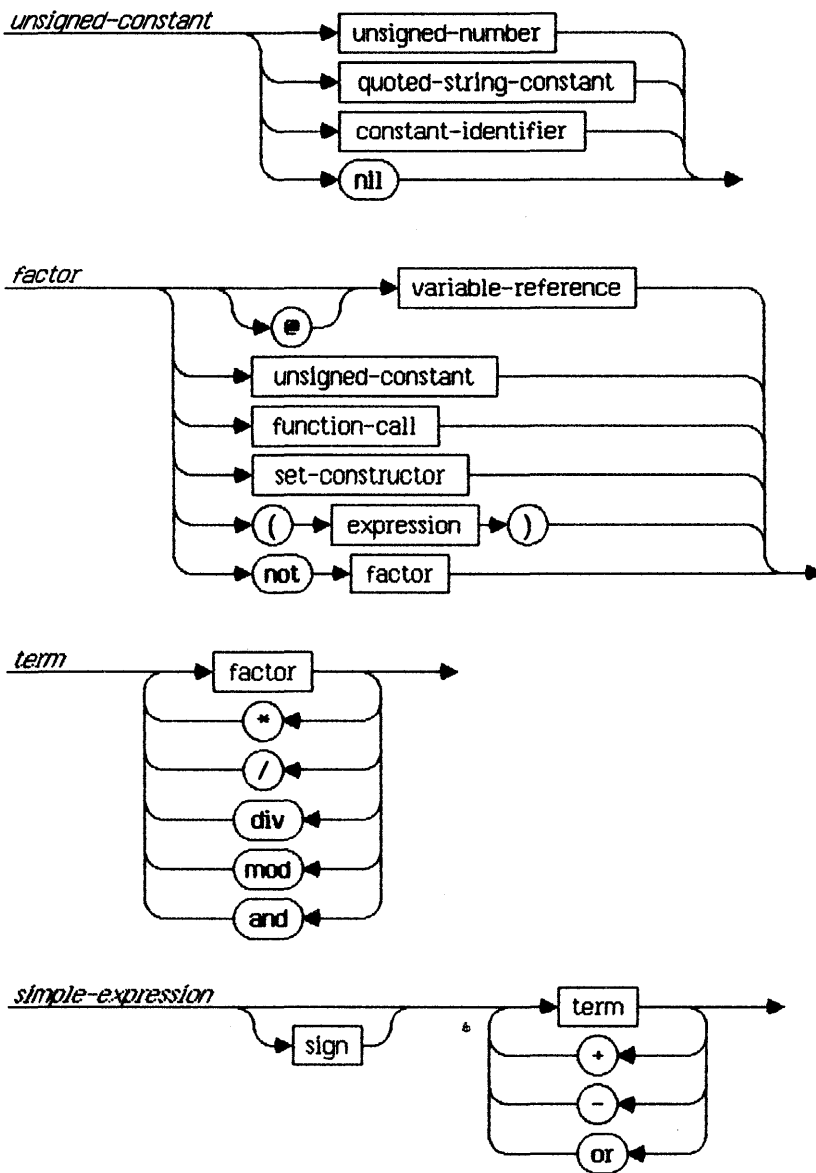

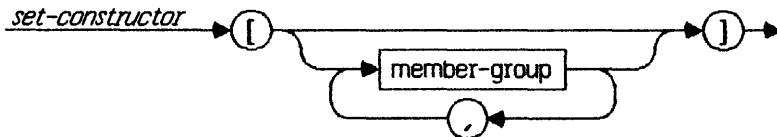
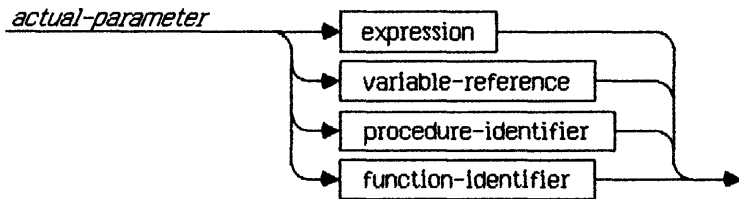
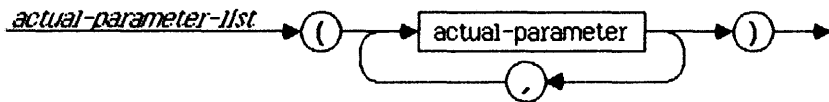
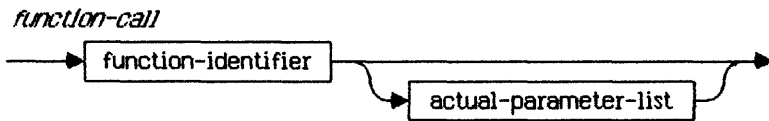
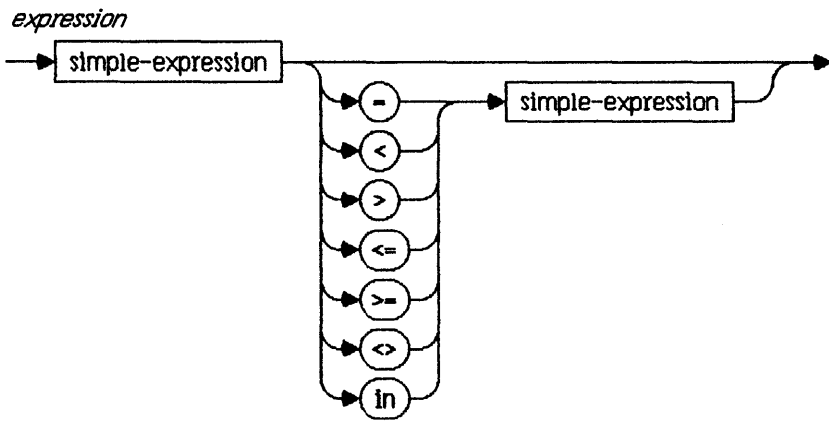



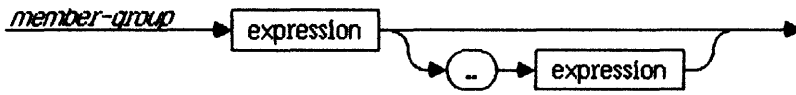

C.6 Statements (see Chapter 6)

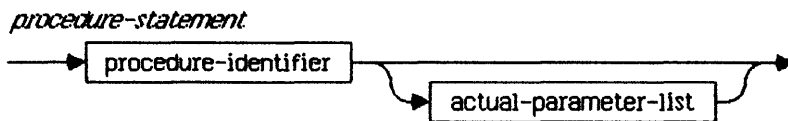
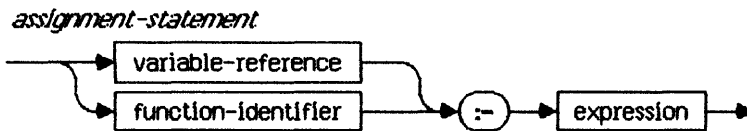
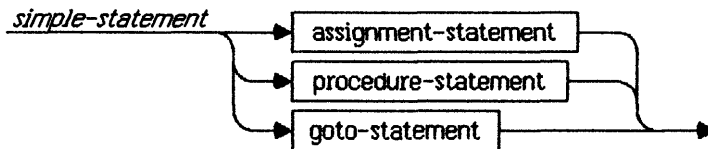
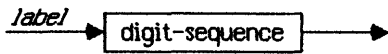
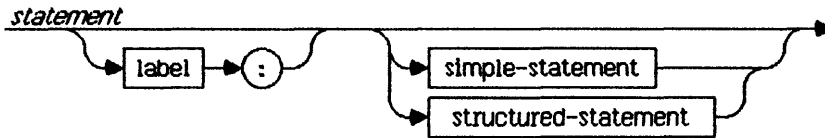

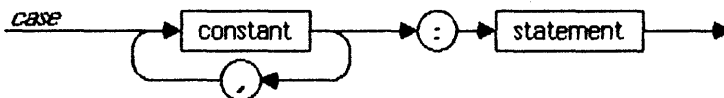
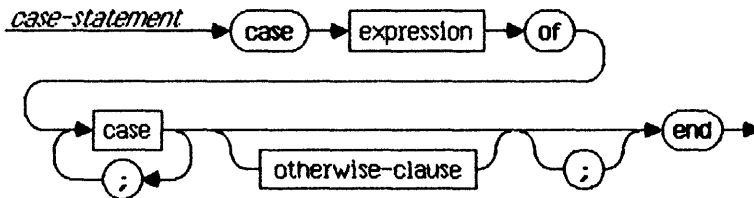
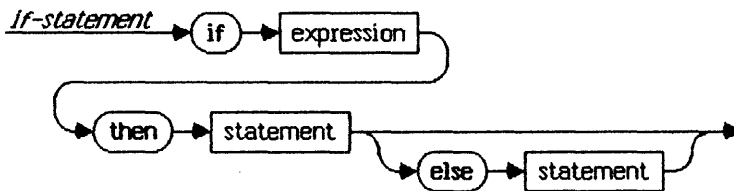
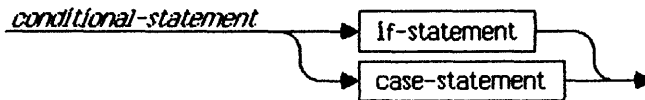
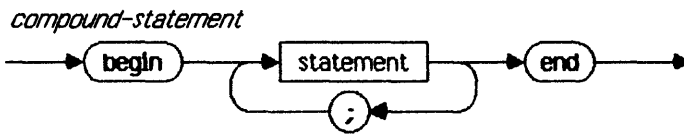
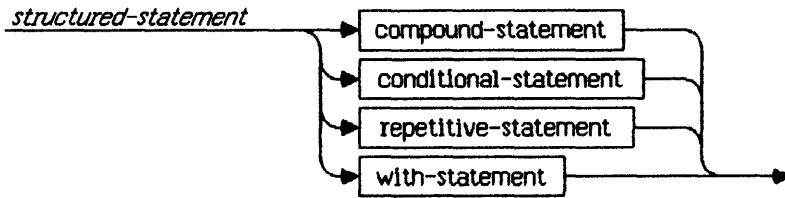

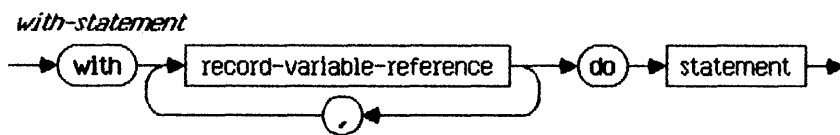
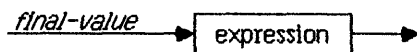
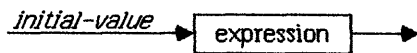
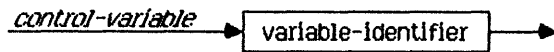
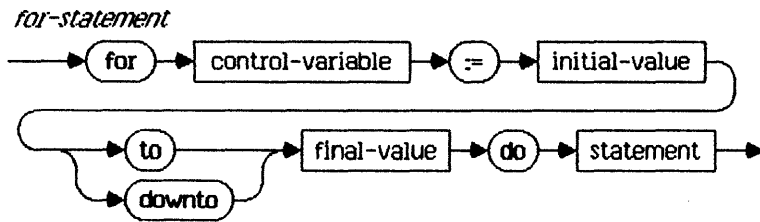
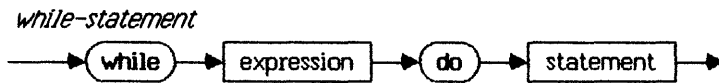
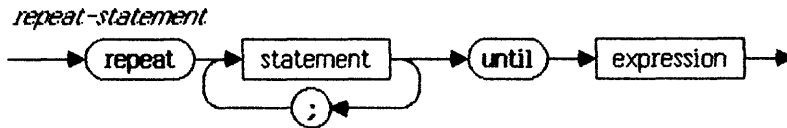
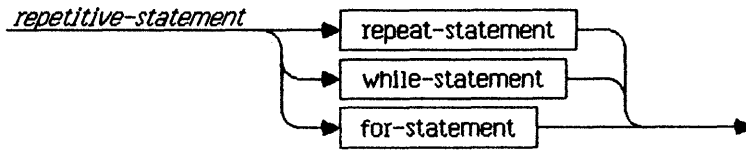

C.7 Procedures and Functions (see Chapter 7)

*procedure-declaration*



*procedure-body*

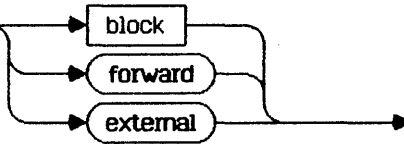

*procedure-heading*

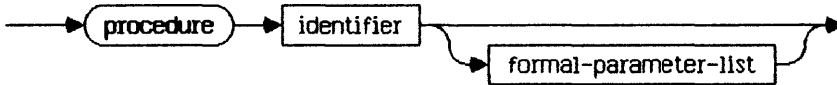

*function-declaration*



*function-body*

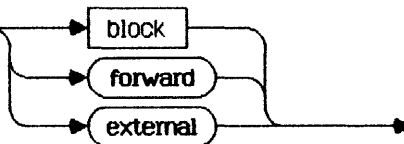

*function-heading*

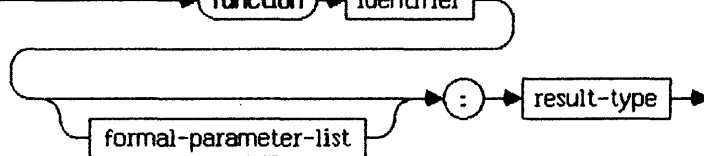

*result-type*

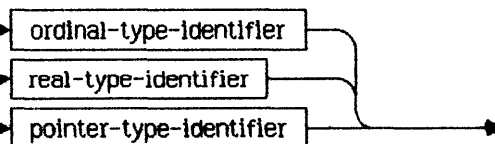

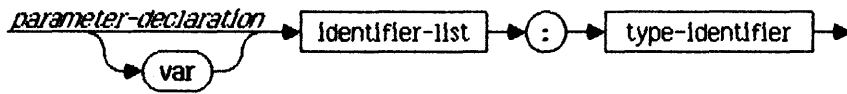
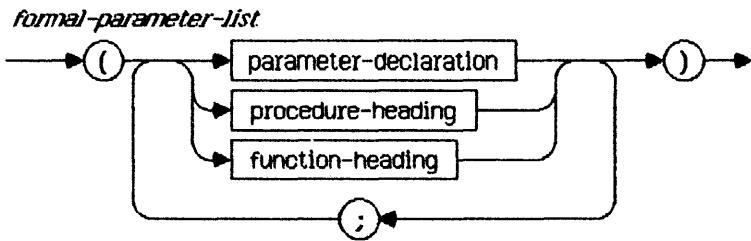

C.8 Programs (see Chapter 8)

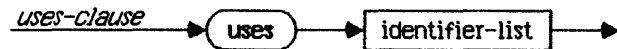
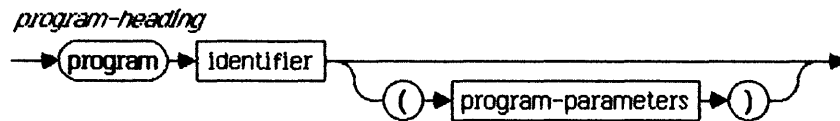
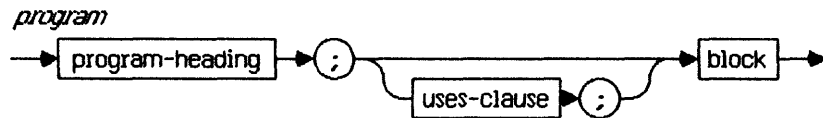

C.9 Units (see Chapter 9)

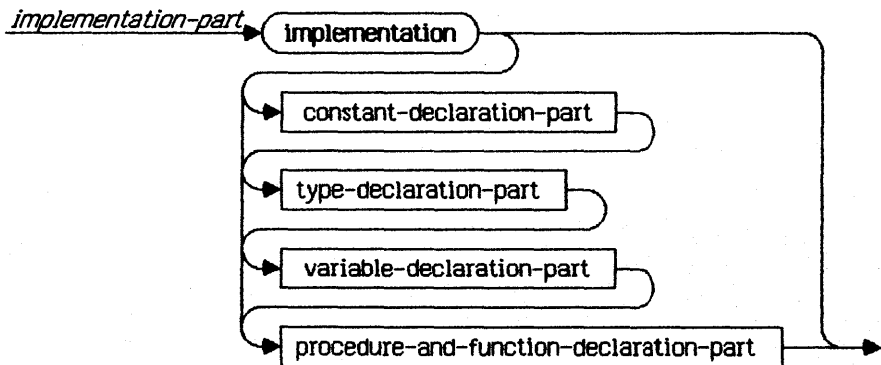
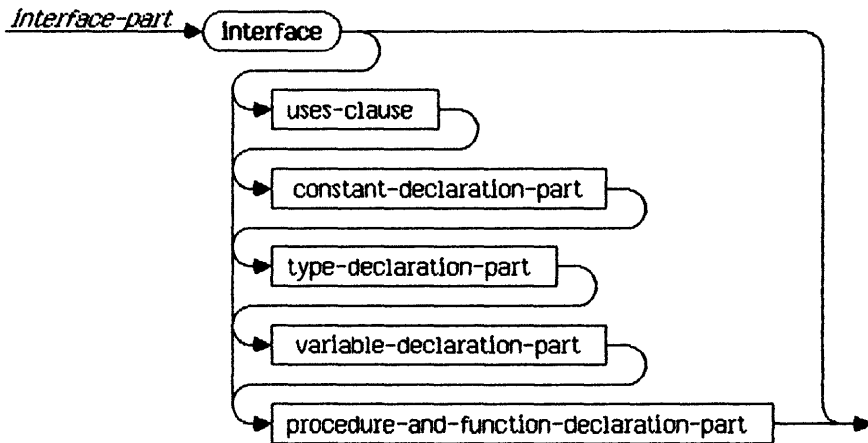
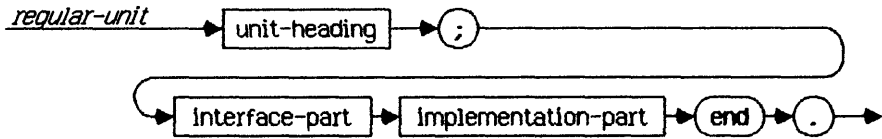



# Appendix D

## Floating-Point Arithmetic

<b>D.1</b>	<b>Preface</b> .....	<b>D-1</b>
<b>D.2</b>	<b>Pascal Real Arithmetic</b> .....	<b>D-1</b>
D.2.1	Introduction .....	D-1
D.2.2	Rounding .....	D-2
D.2.3	Infinity Arithmetic .....	D-2
D.2.4	NaN Arithmetic .....	D-3
<b>D.3</b>	<b>FPLib</b> .....	<b>D-4</b>
D.3.1	Introduction .....	D-4
D.3.2	Data Types .....	D-7
D.3.3	Arithmetic Operations .....	D-7
D.3.3.1	Add, Subtract, Multiply, and Divide .....	D-7
D.3.3.2	Remainder .....	D-8
D.3.3.3	Square Root .....	D-8
D.3.4	Conversions .....	D-9
D.3.4.1	Conversions to and from Extended .....	D-9
D.3.4.2	Conversions Between Binary and Decimal .....	D-9
D.3.5	Expression Evaluation .....	D-11
D.3.5.1	Global Constants .....	D-14
D.3.6	Comparison Functions .....	D-14
D.3.7	Infinities, NaNs, and Denormalized Numbers .....	D-15
D.3.7.1	Inquiries: NumClass and the Class Function .....	D-15
D.3.8	Environmental Control .....	D-16
D.3.8.1	Rounding Direction .....	D-16
D.3.8.2	Exception Flags and Halts .....	D-17
D.3.8.3	Managing Environmental Settings .....	D-17
D.3.9	Auxiliary Procedures .....	D-18
D.3.9.1	Round to Integral Value .....	D-18
D.3.9.2	Sign Manipulation .....	D-19
D.3.9.3	Next-After .....	D-19
D.3.9.4	Binary Scale and Log .....	D-19
D.3.10	Elementary Functions .....	D-19
D.3.10.1	Logarithms .....	D-20
D.3.10.2	Exponentials .....	D-21
D.3.10.3	Financial Functions .....	D-22
D.3.10.4	Trigonometric Functions .....	D-24
D.3.10.5	Random Number Generator .....	D-24
D.3.11	Additional FPLib Procedures .....	D-25
D.3.12	FPLib Interface .....	D-28



<b>D.4</b>	<b>MathLib</b> .....	<b>D-35</b>
D.4.1	How to Use MathLib .....	D-35
D.4.2	Environment Procedures .....	D-35
D.4.3	Elementary Functions .....	D-36
D.4.4	Utility Procedures .....	D-38
D.4.5	Sorting .....	D-39
D.4.6	Free Format Conversion to ASCII .....	D-41
D.4.7	Correctly Rounded Conversion Between Binary and Decimal .....	D-45
D.4.8	Financial Analysis .....	D-46
D.4.9	Zero of a Nonlinear Function .....	D-51
D.4.10	Linear Algebra .....	D-55
	D.4.10.1 Vectors and Linear Transformations .....	D-55
	D.4.10.2 Transformations Between Spaces of Different Dimension .....	D-56
	D.4.10.3 Arrays and Matrices .....	D-56
	D.4.10.4 Ill-Conditioned Problems .....	D-60
	D.4.10.5 Determinants .....	D-60
	D.4.10.6 Iterative Improvement .....	D-61
	D.4.10.7 Statistical Computations with $A^T A$ .....	D-61
	D.4.10.8 Linear Algebra Procedures .....	D-62
	D.4.10.9 QR Factorization .....	D-66
	D.4.10.10 MathLib QR Procedures .....	D-67
	D.4.10.11 QR Example .....	D-68
D.4.11	MathLib NaNs .....	D-70
D.4.12	MathLib Interface .....	D-71
<b>D.5</b>	<b>Macintosh Floating-Point Programming</b> .....	<b>D-79</b>
D.5.1	Assembly Language .....	D-79
D.5.2	Pascal Real Arithmetic .....	D-79
D.5.3	FPLib and MathLib .....	D-79
D.5.4	Restrictions .....	D-80

# Floating-Point Arithmetic

## D.1 Preface

This appendix describes Pascal **real** arithmetic and two Lisa intrinsic units, FPLib and MathLib. FPLib is a Pascal interface for SANE (the Standard Apple Numerics Environment). MathLib contains various mathematical routines, including routines for sorting, formatting, financial analysis, zero finding, and linear algebra.

This appendix refers to two documents:

- *The Standard Apple Numeric Environment*
- *The 68000 Assembly-Language SANE Engine*

These documents are Parts I and III of the *Apple Numerics Manual*, and are included in the third volume of this set, the System Software Manuals. (Part II of the *Apple Numerics Manual*, *The 6502 Assembly-Language SANE Engine*, is not included in this set.)

*Linking:* When using Pascal **real** variables or constants or the units FPLib or MathLib, you must include IOSFPLib, in addition to IOSPasLib, in your list of files to be linked.

### Macintosh

Pascal programs can be compiled on the Lisa to run on the Macintosh. Floating-point usage is slightly different, and some restrictions apply, as described in Section D.5.

## D.2 Pascal Real Arithmetic

### D.2.1 Introduction

Lisa Pascal **real** arithmetic conforms to as many of the requirements of a single-precision implementation of IEEE arithmetic as can be expressed in the standard Pascal language syntax. IEEE arithmetic is described in *A Proposed Standard for Binary Floating-Point Arithmetic*, Draft 10.0 of IEEE Task P754, December 2, 1982.

SANE (the Standard Apple Numeric Environment), which contains a completely conforming extended-precision implementation of IEEE arithmetic, is in the intrinsic unit FPLib. FPLib, which also contains elementary functions, and MathLib, which contains the higher mathematical procedures used in LisaCalc and Lisa BASIC, are in the file IOSFPLib. FPLib and MathLib are described in Sections D.3 and D.4 of this appendix.

If, however, you only wish to use the features of Pascal **real** arithmetic as defined in the Pascal language standard, you do not need to use either of these units in your source code. Pascal **real** arithmetic will then operate according to the default modes for IEEE single-precision arithmetic. IEEE

arithmetic works like conventional floating-point arithmetic, except sometimes it works better. In particular, results are defined for all floating-point operations; invalid operations never terminate execution and always supply appropriate results. When examining printed results produced by a **write** of a **real** variable:

- A number that looks normal is a faithful representation, within the format specification, of the binary number held internally.
- "0" or "-0" represent exactly zero with positive or negative sign respectively. Positive and negative zeros behave identically most of the time, but  $1/0$  yields positive infinity and  $1/(-0)$  yields negative infinity.
- "INF" or "-INF" are the representations of positive and negative infinity. They can be produced by floating-point overflow as well as by division by zero.
- "NaN" or "-NaN" represent Not-a-Number, used to represent an undefined or erroneous value. Often the representation includes a parenthesized NaN code; for instance, **write(sqrt(-1))** produces "NaN(1)." NaN codes are described in *The Standard Apple Numeric Environment*.

Normal numbers that are printed with nine or more significant digits can be read back in to produce the same binary value. The strings printed for infinite and NaN values are accepted by **read**, and produce the same binary **real** value that produced the string. The strings for infinity and NaN are *not* accepted by the Compiler as real constants in Pascal source code, however.

### D.2.2 Rounding

When the result is not representable exactly as a **real** value, then it is rounded to the nearest representable real value. If the result is exactly half way between two representable real values, then it is rounded to the even representable value which has a zero in its least significant bit.

### D.2.3 Infinity Arithmetic

Infinity arithmetic obeys common mathematical conventions as indicated in the tables on the following page.

**Table D-1**  
**Results of Addition and Subtraction on Infinities**

<i>Left Operand</i>		<i>Right Operand</i>		
		-INF	finite	+INF
-INF	<b>+</b>	-INF	-INF	NaN
finite		-INF	finite†	+INF
+INF		NaN	+INF	+INF
-INF	<b>-</b>	NaN	-INF	-INF
finite		+INF	finite†	-INF
+INF		+INF	+INF	NaN

† Result is infinite if the operation overflows.

**Table D-2**  
**Results of Multiplication and Division on Infinities**

<i>Left Operand</i>		<i>Right Operand</i>		
		±0	finite	±INF
±0	<b>*</b>	±0	±0	NaN
finite		±0	finite†	±INF
±INF		NaN	±INF	±INF
±0	<b>/</b>	NaN	±0	±0
finite		±INF	finite†	±0
±INF		±INF	±INF	NaN

† Result is infinite if the operation overflows.

*Note:* Sign of result is determined by signs of operands in the usual manner.

**D.2.4 NaN Arithmetic**

NaNs are produced as the result of an invalid operation such as **sqrt(-1)**, **INF-INF**, **0/0**, **0\*INF**, **ln(-1)**, or **sin(INF)**. If one or more NaN is an operand to any operation that produces a floating-point result, that result will be a NaN.

Comparisons involving NaNs are never less than, equal to, or greater than; they are always unequal. So if  $x$  is a NaN,  $x < > y$  will be true, while  $x < y$ ,  $x \leq y$ ,  $x = y$ ,  $x \geq y$ , and  $x > y$  will always be false regardless of  $y$ . "If  $x < > x$ " is a good test of whether  $x$  is a NaN.

**Round** and **trunc** operations upon NaNs produce undefined values since integers do not have NaN values. **Round** and **trunc** of numbers too large to represent as integers also produce undefined values.

## D.3 FPLib

### D.3.1 Introduction

This section describes the Lisa intrinsic unit FPLib, which is a Pascal interface for SANE (the Standard Apple Numeric Environment). SANE in turn implements P754, the proposed IEEE Standard for binary floating-point arithmetic.

SANE data types, operations, and exceptions are described in detail in *The Standard Apple Numeric Environment*. This section describes only the FPLib interface for Pascal programs. The FP68K interface for assembly-language programs is described in *The 68000 Assembly-Language SANE Engine*.

If you are familiar with Pascal, you should be able to use most of FPLib just on the basis of the comments in the interface in Section D.3.12.

When writing Pascal source code, include a **uses** statement such as:

```
USES FPLib;
```

after the program statement in a main program or after the interface statement in a unit.

The two examples that follow, a program and a unit, illustrate the use of FPLib. We encourage you to type in these examples, to compile them, and, in the case of the program, to execute the code file while following this discussion.

#### *Example 1*

This program reads an input string representing a floating-point value and echoes it to the screen. It demonstrates the use of SANE data types, and how values can be accepted on input and displayed on output.

```
program EchoNumber;
```

```
Uses  
  FPLib;
```

```
Var  
  InStr, OutStr : DecStr;      { Input and output strings. }  
  x : Single;                 { Single value of InStr. }  
  f : DecForm;                { Specifies output format. }
```

```

begin { EchoNumber }

    f.style := FLOATDECIMAL;    { Floating output format. }
    f.digits := 9;              { 9 significant digits. }

    write ('Enter number: ');
    readln (InStr);             { Read first input string. }
    while InStr <> '' do begin
        Str2S (InStr, x);       { Convert input to Single value x. }
        S2Str (f, x, OutStr);   { Convert x to string by f. }
        writeln (OutStr);
        write ('Enter number: ');
        readln (InStr)         { Read next input string. }
    end

end { EchoNumber }

```

In the program EchoNumber, note that:

- The input and output strings (InStr and OutStr) are of type DecStr, a Pascal string type defined by FPLib.
- A variable x of type Single has been declared to hold the value of the input string.
- The variable f is of type DecForm, which specifies the format of the output string. In this case, f is assigned so that the output will be in FLOATDECIMAL format (as opposed to FIXEDDECIMAL), and will show 9 significant digits.
- The FPLib routine Str2S converts the ASCII characters from the input string InStr to the Single value x.
- The FPLib procedure S2Str converts the Single value x to the output string OutStr. The format of this string is determined by the value of f.

Throughout FPLib, the names of procedures reflect the data types involved. For example, Str2S converts to Single. There are also procedures Str2D, Str2C, and Str2X for converting to the other SANE data types Double, Comp, and Extended, respectively.

Now compile and execute the program, trying out various input values. You will note that the input string '0.5' is echoed (as you would expect) as '5.00000000E-1', whereas the input value '0.1' is echoed as '1.00000001E-1', because of roundoff, as discussed in *The Standard Apple Numeric Environment*.

*Example 2*

The second example shows the use of FPLib from another unit. This example also shows how expression evaluation is accomplished using Extended intermediate variables.

The unit provides a procedure to evaluate the dot product of two vectors. The input vectors *v* and *w* (of type *Vector*) are represented as arrays of *Single* values. The desired result is the *Single* value *z*. In order to compute the value of *z* with maximum accuracy, all of the intermediate calculations are performed in extended precision. This feature is at the heart of the design of SANE.

```

unit DotProd;

INTERFACE
  uses
    FPLib;
  const
    N = 20;      { Size of Vector. }
  type
    Vector = array [1..N] of Single;
  procedure DotProduct (v,w: Vector; var z: Single);

IMPLEMENTATION

  procedure DotProduct { (v,w: Vector; var z: Single) };
    { Returns the dot product of v and w in z,
      accumulated in Extended and returned in Single. }

    var s, t : Extended;
        i : 1..N;

  begin { DotProduct }

    IZX (0, s);      { s ← 0 }
    for i := 1 to N do begin
      SZX (v[i], t);  { t ← v[i] }
      MulS (w[i], t); { t ← v[i] * w[i] }
      { Accumulate in Extended. }
      AddX (t, s)     { s ← s + t }
    end;
    XZS (s, z)       { Produce Single result. }

  end { DotProduct };

end { DotProd } .

```

In the procedure `DotProduct`, note that:

- The sum `s` is initialized to zero using `I2X` (`I2X` provides convenient and efficient assignment of integral constants to `Extended`).
- A `Single` value from `v` is converted to extended precision in the temporary variable `t`. This conversion is performed by `S2X` and is exact.
- `T` is directly multiplied by the corresponding value from `w`, leaving the extended-precision result in `t`.
- The sum is accumulated in extended precision by adding `t` directly to the `Extended` value `s`.
- When the loop completes, the sum in `s` is converted, using `X2S`, to the desired `Single` result `z`.
- In `FPLib`, all of the basic arithmetic operations on two values are two-address operations; that is, the operation is performed on the two inputs and the result is stored in the second argument (as in `MulS` and `AddX` in the example).
- All arithmetic operations are performed in extended precision and the result is returned in `Extended`.
- The names of the procedures again reflect the type of the input argument: `MulS` multiplies an `Extended` by a `Single`, `AddX` adds an `Extended` to an `Extended`, and `X2S` converts an `Extended` to a `Single`.

### D.3.2 Data Types

`FPLib` fully supports the SANE data types `Single`, `Double`, `Comp`, and `Extended`.

Pascal's 16- and 32-bit integer arithmetic remains distinct from SANE arithmetic. However, any program using the `FPLib` unit can use Pascal integer arithmetic.

### D.3.3 Arithmetic Operations

This section discusses the arithmetic operations `add`, `subtract`, `multiply`, `divide`, `remainder`, and `square root`.

#### D.3.3.1 Add, Subtract, Multiply, and Divide

The arithmetic operations `add`, `subtract`, `multiply`, and `divide` are provided by sixteen procedures:

```
AddS, AddD, AddC, AddX;
SubS, SubD, SubC, SubX;
MulS, MulD, MulC, MulX;
DivS, DivD, DivC, DivX.
```

Each procedure has two operands. The first is always a value parameter of type `Single`, `Double`, `Comp`, or `Extended`, as indicated by the last letter of the



procedure name. The second is always a variable parameter of Extended type that receives the result. For example, subtraction is provided by the procedures SubS (subtract Single), SubD (subtract Double), SubC (subtract Comp), and SubX (subtract Extended). If  $x$  and  $y$  are declared by

```
var x : Single;
    y : Extended;
```

then the statement

```
SubS (x, y);           { y ← y - x }
```

causes  $x$  to be subtracted from  $y$  and the extended-precision result to be stored in  $y$ .

*Example*

To compute  $q = a / b$ , where  $a$ ,  $b$ , and  $q$  are of type Double, declare:

```
var a, b, q : Double;
    t : Extended;   { extended temporary }
```

and write:

```
D2X (a, t);           { t ← a }
DivD (b, t);          { t ← a / b }
X2D (t, q);           { q ← t }
```

### D.3.3.2 Remainder

The remainder operation is provided by

```
procedure RemX (x : Extended; var y : Extended; var quo : integer);
```

The remainder,  $y \text{ REM } x$ , is delivered to  $y$ .

The remainder operation determines  $n$ , the nearest integer to  $x/y$ ; if  $x/y$  is halfway between two integers, the even integer is chosen. Thus,  $y \text{ rem } x = y - n*x$ .

The third argument,  $quo$ , delivers the integer whose magnitude is given by the seven least significant bits of the magnitude of  $n$ , and whose sign is the sign of  $n$ . ( $Quo$  is useful for reducing the arguments of trigonometric functions, but can be ignored if not needed.)

### D.3.3.3 Square Root

The square root operation is provided by

```
procedure SqrtX (var x : Extended);
```

for any  $x \geq 0$ . The argument  $x$  is both source and destination.

*Example*

To find  $v = \text{square root of } u$ , where  $u$  and  $v$  are of type `Single`, declare

```
var  u, v : Single;
     t : Extended;           { extended temporary }
```

and write

```
SZX (u, t);    { t ← u }
SqrtX (t);     { t ← sqrt (u) }
XZS (t, v);    { v ← t }
```

**D.3.4 Conversions****D.3.4.1 Conversions to and from Extended**

Conversions between the `Extended` type and the other numeric types recognized by `FPLib` are provided by the procedures

```
I2X    - integer to Extended
L2X    - longint to Extended
S2X    - Single to Extended
D2X    - Double to Extended
C2X    - Comp to Extended
X2X    - Extended to Extended

X2I    - Extended to integer
X2L    - Extended to longint
X2S    - Extended to Single
X2D    - Extended to Double
X2C    - Extended to Comp
```

For example, if  $x$  and  $y$  are declared by

```
var  x : Comp;
     y : Extended;
```

then to convert a `Comp`-format value in  $x$  to an `Extended`-format in  $y$ , write

```
C2X (x, y);    { y ← x }
```

**D.3.4.2 Conversions Between Binary and Decimal****Converting Decimal Strings into SANE Types**

The procedures `Str2S`, `Str2D`, `Str2C`, and `Str2X` convert numeric strings into `Single`, `Double`, `Comp`, and `Extended` formats, respectively.

*Example 1*

To assign  $-0.0000253$  to an Extended variable *x*, write

```
var x: Extended;
    StrZ ('-2.53E-5', x); { or StrZ ('-0.0000253', x); }
```

*The Standard Apple Numeric Environment* describes numeric string syntax.

**Converting SANE Types into Decimal Strings**

The procedures S2Str, D2Str, C2Str, and X2Str will convert a Single, Double, Comp, and Extended, respectively, into a numeric string (of type DecStr). As any numeric value can have many decimal representations, you must specify the decimal result format. To do so, pass a record of type DecForm, shown below:

```
DecForm = record
    style : (FLOATDECIMAL, FIXEDDECIMAL);
    digits : integer
end;
```

*Example 2*

To print the value of a Double variable *y* using a fixed-point decimal format with ten digits to the right of the decimal point, write:

```
var y: Double;
    s: DecStr;
    f: DecForm;

    f.style := FIXEDDECIMAL;
    f.digits := 10;

    D2Str (f, y, s);
    writeln ('y = ', s);
```

Numbers that round to zero in the specified DecForm are converted to the string '0.0' or '-0.0'. NaN's are converted to the string 'NaN', '-NaN', 'NaN(n)', or '-NaN(n)', where *n* is a NaN error code in decimal. Infinities are converted to the string 'INF' or '-INF'.

All other numbers behave in an intuitive manner as long as the DecForm specifies no more than SIGDIGLEN-1 significant digits. Otherwise, the formatted number is padded with zeros where necessary. If the resulting string has more than DECSTRLEN characters, the number is represented in floating-point notation. (SIGDIGLEN and DECSTRLEN are specified in the interface to FPLib.)

All string results have either a leading negative sign or a leading blank (thus, columns of numbers will line up regardless of sign).

**Decimal Record Conversions**

The Decimal record type is specified in the interface as below:

```

SigDig = string [SIGDIGLEN];

Decimal = record
    sgn : 0..1;    { Sign (0 for pos, 1 for neg). }
    exp : integer; { Exponent. }
    sig : SigDig  { String of significant digits. }
end;
    
```

The procedures S2Dec, D2Dec, C2Dec, and X2Dec each convert a Single, Double, Comp, or Extended value, respectively, into a record of type Decimal. A DecForm operand (shown in the preceding section) specifies the format of Decimal. The maximum number of ASCII digits delivered to sig is SIGDIGLEN-1, and the implied decimal point is at the right end of sig, with exp set accordingly. Further formatting details are given in *The 68000 Assembly-Language SANE Engine*.

The procedures Dec2S, Dec2D, Dec2C, and Dec2X convert a Decimal record into Single, Double, Comp, and Extended, respectively. The sig part of Decimal accepts up to SIGDIGLEN-1 significant digits, with an implicit decimal point at the right end of the significant digits. If SIGDIGLEN digits are passed, then the implicit decimal point is between the digits at SIGDIGLEN-1 and SIGDIGLEN; the last digit, if nonzero, represents one or more nonzero digits in the SIGDIGLEN or subsequent positions. Further details of the representations of Decimal input values for these routines are given in *The 68000 Assembly-Language SANE Engine*.

**D.3.5 Expression Evaluation**

SANE floating-point arithmetic (and the FPLib unit) is designed to operate on Extended values. For example, DivD (x, y) operates on the Extended-format value in y by dividing the Double-format number x into y and leaving the result in y. To evaluate more complicated expressions, Extended temporaries can be used.

The following examples illustrate extended-based expression evaluation. The first example uses an Extended accumulator to store the results of all operations.

*Example 1*

Compute the value of

$$r = \frac{(a + b - c) * d + e}{f}$$

where all variables are of Double type.

```

var a, b, c, d, e, f, r : Double;
    t : Extended;        { extended temporary }
    
```

```

begin
  DZX (a, t);      { t ← a }
  AddD (b, t);     { t ← a + b }
  SubD (c, t);     { t ← a + b - c }
  MulD (d, t);     { t ← (a + b - c) * d }
  AddD (e, t);     { t ← (a + b - c) * d + e }
  DivD (f, t);     { t ← ((a + b - c) * d + e) / f }
  XZD (t, r);     { r ← t }

```

Note that although the arithmetic style is extended-based, not every operand need be converted to Extended. In the example, only one explicit conversion to Extended was required.

*Example 2*

Compute the value of the root  $r$  of larger magnitude of a quadratic equation from the formula:

$$r = - \frac{b + \text{sign}(b) * \text{sqrt}(b^2 - 4 * a * c)}{2 * a}$$

where  $a$ ,  $b$ ,  $c$ , and  $r$  are of Single type.

```

var a, b, c, r : Single;
    t1, t2, t3 : Extended;      { extended temporaries }

```

```

begin
  SZX (b, t1);      { t1 ← b }
  t3 := t1;         { t3 ← b }
  MulS (b, t1);     { t1 ← b^2 }
  IZX (4, t2);     { t2 ← 4 }
  MulS (a, t2);     { t2 ← 4 * a }
  MulS (c, t2);     { t2 ← 4 * a * c }
  SubX (t2, t1);    { t1 ← b^2 - 4 * a * c }
  SqrtX (t1);       { t1 ← sqrt (b^2 - 4 * a * c) }
  CpySgnX (t1, t3); { t1 ← same with sign of b }
  AddS (b, t1);     { t1 ← b + sign(b) * sqrt (b^2 - 4*a*c) }
  NegX (t1);        { t1 ← -(b + sign(b) * sqrt...) }
  SZX (a, t2);     { t2 ← a }
  AddS (a, t2);     { t2 ← 2 * a }
  DivX (t2, t1);    { t1 ← -(b + sign(b) * }
                    { sqrt (b^2 - 4 * a * c)) / (2 * a) }
  XZS (t1, r);     { r ← t1 }

```

The smaller root may then be computed by evaluating the formula  $c/(a*t1)$  in extended. Exceptional cases include  $b^2 < 4 * a * c$  and  $a = 0$ .

*Example 3*

Evaluate the polynomial

$$y = c_0 + c_1 * x + c_2 * x^2 + \dots + c_n * x^n$$

and its derivative

$$Dy = c_1 + 2 * c_2 * x + 3 * c_3 * x^2 + \dots + n * c_n * x^{(n-1)}$$

where the coefficients  $c_0$  through  $c_n$  are stored in an array of Single and  $x$ ,  $y$ , and  $Dy$  are of type Single.

```

const   NMAX = 100;

var     n, i : 0..NMAX;
        x, y, Dy : Single;
        c : array [0..NMAX] of Single;
        t1,
        t2, t3 : Extended;

        IZX (0, t1);
        t2 := t1;

        for i := n downto 1 do begin
            { t1 ← c [i] + x * t1 : }
            MulS (x, t1);
            AddS (c [i], t1);
            { t1 ← x * t1 }
            { t1 ← c [i] + t1 }

            { t2 ← t1 + x * t2 : }
            MulS (x, t2);
            SZX (c[i], t3);
            MulS (i, t3);
            AddX (t3, t2)
            { t2 ← x * t2 }

        end;

        { t1 ← c [0] + x * t1 : }
        MulS (x, t1);
        AddS (c [0], t1);
        { t1 ← x * t1 }
        { t1 ← c [0] + t1 }

        XZS (t1, y);
        { y ← t1 }

        XZS (t2, Dy);
        { Dy ← t2 }

```

The method, called Horner's Rule, used to evaluate the polynomials is based on the polynomial representation

$$y = ( \dots ((c_n * x + c_{n-1}) * x + c_{n-2}) * x + \dots ) * x + c_0.$$

It is faster and more accurate than the straightforward computation suggested by the standard representation, shown at the beginning of the example, and is conveniently implemented using SANE's extended-based arithmetic.

### D.3.5.1 Global Constants

To speed up execution, frequently used constants can be defined globally (outside the routines). For example, if pi is declared and defined by:

```
var    pi : Extended;
      . . .
begin
      . . .
      Str2X ('3.14159265358979323846', pi);
```

then executing

```
x := pi;
```

is significantly faster than

```
Str2X ('3.14159265358979323846', x);
```

Defining constants globally is particularly helpful when the definition is via one of the string conversion routines, such as Str2X. For conversion of integers, I2X and L2X are significantly faster than Str2X.

### D.3.6 Comparison Functions

Any two floating-point values in the Extended format can be compared using:

```
function CmpX (x : Extended; r : RelOp; y : Extended) : boolean;
```

or

```
function RelX (x, y : Extended) : RelOp;
```

The RelOp values are

```
GT    greater than
LT    less than
GL    greater than or less than
EQ    equal
GE    greater than or equal
LE    less than or equal
GEL   greater than, equal, or less than
UNORD unordered
```

Single, Double, or Comp values can be compared by first converting them to Extended.

For every pair of operand values, exactly one of the relations LT, GT, EQ, and UNORD is true. The value of RelX is the appropriate one of these four relations. CmpX (x, r, y) is true if and only if the relation  $x \text{ r } y$  is true.

*Example*

If p is greater than q then print 'p > q is TRUE'; otherwise, print 'p > q is FALSE'.

```
var    p, q: Extended;
if CmpX (p, GT, q) then
  writeln ('p > q is TRUE')
else
  writeln ('p > q is FALSE');
```

Note that equivalent results are produced by

```
if CmpX (p, LE, q) or CmpX (p, UNORD, q) then
  writeln ('p > q is FALSE')
else
  writeln ('p > q is TRUE');
```

or by

```
case RelX (p, q) of
  GT:    writeln ('p > q is TRUE');
  LT, EQ: writeln ('p > q is FALSE');
  UNORD: begin
           SetXcp (INVALID, TRUE);
           writeln ('p > q is FALSE')
         end { UNORD }
end; { case RelX }
```

### D.3.7 Infinities, NaNs, and Denormalized Numbers

In addition to the normalized numbers supported by most floating-point packages, FPLib fully supports the special values--infinities, NaNs, and denormalized numbers--specified by the IEEE Standard, as described in *The Standard Apple Numeric Environment*.

#### D.3.7.1 Inquiries: NumClass and the Class Functions

The functions ClassS, ClassD, ClassC, and ClassX can be used to classify the value of a variable. These functions are of type NumClass and return one of the values:



SNAN	- signaling NaN
QNaN	- quiet NaN
INFINITE	- infinity
ZERO	- zero
NORMAL	- normalized number
DENORMAL	- denormalized number

The class functions also return the sign of a value in the parameter  
var sgn: integer.

### D.3.8 Environmental Control

Environmental controls supported in FPLib include the rounding direction, as well as exception flags and their corresponding halts. Rounding precision is supported in the MathLib unit.

#### D.3.8.1 Rounding Direction

The rounding directions are of the type

**RoundDir = (TONEAREST, UPWARD, DOWNWARD, TOWARDZERO)**

The rounding direction is set by the SetRnd and SetEnv procedures and can be interrogated by the GetRnd function.

*Example*

The common rounding function specified by

$$\text{Rnd}(x) = \begin{cases} \text{trunc}(x + 0.5), & \text{if } x \geq 0 \\ \text{trunc}(x - 0.5), & \text{if } x < 0 \end{cases} \quad \text{***insert bracket***}$$

can be implemented by:

```
function Rnd (x : Extended) : integer;
{ Sets INVALID and returns -32768 if
  x is a NaN or x <= -32768.5 or x >= 32767.5.

  Sets INEXACT if
  -32768.5 < x < 32767.5 and x is nonintegral.

  Sets no other exceptions. }
var t : Extended;
    i : integer;
    r : RoundDir;
```

```

begin { Rnd }

  Str2X ('0.5', t);
  CpySgnX (t, x);           { t ← +0.5 if x > 0 or x is +0 }
                           { t ← -0.5 if x < 0 or x is -0 }
  r := GetRnd;             { Save rounding direction. }
  SetRnd (TOWARDZERO);    { Set round-toward-zero. }
  AddX (x, t);            { t ← x + t }
  X2I (t, i);             { i ← truncate (t) }
  I2X (i, t);            { No exceptions! }
  SetXcp (INEXACT, not (CmpX (t, EQ, x) or TestXcp (INVALID)));
                           { Correct INEXACT setting. }
  SetRnd (r);             { Restore rounding direction. }
  Rnd := i;               { On INVALID, i ← -32768. }

end { Rnd };

```

### D.3.8.2 Exception Flags and Halts

The exception flags are values of the type

**Exception = (INVALID, UNDERFLOW, OVERFLOW, DIVBYZERO, INEXACT)**

These five exceptions are signaled when detected, and if the corresponding halt is set, the SANE engine will JSR to the 'halt vector'. The halt vector is initially 0, so that halts terminate execution with a bus error. However, the user can call the procedure SetHltAddress to set the halt vector to the address of a user-defined halt-handling procedure. See Section D.3.11 for details.

Initially all exception flags and halts are cleared. You can examine, set, or clear individual exception flags and halts using TestXcp and TestHlt functions and SetXcp and SetHlt procedures. The SetEnv and GetEnv procedures can be used to set or get the entire environment (rounding direction, rounding precision, exception flags, and halts).

### D.3.8.3 Managing Environmental Settings

Issues and techniques for managing environmental settings are covered in *The Standard Apple Numeric Environment*. (The Pascal syntax used in the examples there does not fully match the syntax in FPLib.)

The procedure-entry and procedure-exit routines are provided in FPLib by:

```

procedure ProcEntry (var e: Environ);
procedure ProcExit (e: Environ);

```

#### *Example*

The following procedure signals underflow if its result is denormal, and overflow if its result is infinite, but hides spurious exceptions occurring from

internal computations. This is Example 3 in Section 8 of *The Standard Apple Numeric Environment*, implemented with FPLib calls.

```

procedure compres (var x: Double);
uses FPLib;
  ---
  var e: Environ;           { local storage for environment }
      c: NumClass;         { for class inquiry }
      sgn: integer;       { for class inquiry - not used }
  ---
  procedure clearxcps;     { more efficient version in MathLib }
  const FIRSTXCP          = INVALID;
        LASTXCP           = INEXACT;
  var xcp: Exception;     { for clearing exceptions }
  begin {clearxcps}
    for xcp:= FIRSTXCP to LASTXCP do
      SetXcp (xcp, FALSE)
    end {clearxcps};

  begin {compres}
    ProcEntry (e);        { save caller's environment and
                          { set default environment -
                          { now halts disabled }

    ---
    { compute result x }
    ---
    c := ClassD (x, sgn); { class inquiry }
    clearxcps;           { clear possibly spurious exceptions }
    { now raise specified exception flags:
    if c = INFINITE then SetXcp (OVERFLOW, TRUE)
    else if c = DENORMAL then SetXcp (UNDERFLOW, TRUE);
    ProcExit (e)         { restore caller's environment,
                          { including any halt enables, and
                          { then signal exceptions from
                          { subroutine }

  end {compres} ;
  
```

### D.3.9 Auxiliary Procedures

The FPLib unit includes a set of special routines: RintX, NegX, AbsX, CpySgnX, NextS, NextD, NextX, ScalbX, and LogbX.

#### D.3.9.1 Round to Integral Value

An Extended variable can be rounded to an integral value by

```
procedure RintX (var x : Extended);
```

The result is returned in the input x.

**D.3.9.2 Sign Manipulation**

Procedures `NegX`, `AbsX`, and `CpySgnX` each operate on an Extended variable, altering only the sign of the Extended argument.

The negation operation is provided by

```
procedure NegX (var x : Extended);
```

The absolute value operation is provided by

```
procedure AbsX (var x : Extended);
```

An operation to copy the sign of one Extended variable to the sign of another is provided by

```
procedure CpySgnX (var x : Extended; y : Extended);
```

which copies the sign of `y` into the sign of `x`.

**D.3.9.3 Next-After**

The procedures `NextS`, `NextD`, and `NextX` each generate the next representable neighbor in its respective format, given an initial value and a direction. The first argument (`x`) to each of these routines is "bumped" to the next representable value in the direction of the second argument (`y`).

The procedure `NextS` bumps the Single value `x` to the next representable Single value in the direction of `y`:

```
procedure NextS (var x : Single; y : Single);
```

The procedure `NextD` bumps the Double value `x` to the next representable Double value in the direction of `y`:

```
procedure NextD (var x : Double; y : Double);
```

The procedure `NextX` bumps the Extended value `x` to the next representable Extended value in the direction of `y`:

```
procedure NextX (var x : Extended; y : Extended);
```

**D.3.9.4 Binary Scale and Log**

An Extended variable can be efficiently scaled by a power of two by

```
procedure ScalbX (n : integer; var y : Extended);
```

The procedure `ScalbX` computes  $y * 2^n$ , and returns it in `y`.

The binary exponent of an Extended variable can be determined by

```
procedure LogbX (var x : Extended);
```

The procedure `LogbX` returns in `x` the binary exponent of `x` as a signed integral value.

**D.3.10 Elementary Functions**

FPLib provides a number of mathematical functions, including logarithms and exponentials, two important financial functions, trigonometric functions, and a

random number generator. The logarithms and exponentials are provided in base-2 and base-e versions.

#### D.3.10.1 Logarithms

The procedures Log2X, LnX, and Ln1X each operate on an Extended variable, returning the result in the input argument.

The base-2 logarithm  $\log_2 x$  is computed by

```
procedure Log2X (var x : Extended);
```

for any nonnegative x.

The natural (base-e) logarithm  $\log_e x$  is computed by

```
procedure LnX (var x : Extended);
```

for any nonnegative x.

The natural (base-e) logarithm  $\log_e (1 + x)$  is computed by

```
procedure Ln1X (var x : Extended);
```

for any  $x \geq -1$ .

#### D.3.10.2 Exponentials

Procedures Exp2X, ExpX, and Exp1X each operate on an Extended variable, returning the result in the input argument. Procedure XpwrI operates on an Extended variable using an integer value, returning the result in the Extended input argument. Procedure XpwrY operates on two Extended variables, returning the result in the second input argument.

The procedure Exp2X calculates  $2^x$  and returns this value to x:

```
procedure Exp2X (var x : Extended);
```

The procedure ExpX computes  $e^x$  and returns this value to x:

```
procedure ExpX (var x : Extended);
```

The procedure Exp1X computes  $e^x - 1$  and returns this value to x:

```
procedure Exp1X (var x : Extended);
```

The procedure XpwrI computes  $x^i$  and returns this value to x:

```
procedure XpwrI (i : integer; var x : Extended);
```

The procedure XpwrY computes  $x^y$  and returns this value to x:

```
procedure XpwrY (y : Extended; var x : Extended);
```

**D.3.10.3 Financial Functions**

FPLib provides two procedures, *Compound* and *Annuity*, that can be used to solve various financial problems. Each of these procedures takes two input arguments of type *Extended*, and produces an *Extended* result. The two input arguments, *r* and *n*, represent in each case an interest rate and a number of periods, respectively.

**Compound Interest**

Compound interest can be computed using

```
procedure Compound (r, n : Extended; var x : Extended);
```

This procedure computes the value

$$x = (1 + r)^n,$$

where *r* is the interest rate and *n* is the number of periods.

*Example*

If \$1000 is invested for 6 years at 9% compounded quarterly, then what is the future value of the principal? Compute:

```
var   r, n, four, years, rate, PV, FV : Extended;
      f : DecForm;
      s : DecStr;
      ...

with f do begin style := FIXEDDECIMAL; digits := 2 end;

      IZX (4, four);           { four ← 4 }
      IZX (6, years);          { years ← 6 }
      StrZX ('0.09', rate);    { rate ← 9% }
      IZX (1000, PV);          { PV ← 1000.00 }

      r := rate;
      DivX (four, r);         { r ← rate / 4 }
      n := years;
      MulX (four, n);         { n ← 4 * years }

      Compound (r, n, FV);   { FV ← (1 + r)^n }
      MulX (PV, FV);         { FV ← PV * (1 + r)^n }

      X2Str (f, FV, s);     { f is FIXED with 2 fraction digits. }
      writeln ('FV = $', s);
```

The future value *FV* is \$ 1705.77.

*Example*

How much must a person invest today at 9% compounded quarterly to have \$15,000 in his account in 6 years? Assuming *f*, *rate*, *years*, *r*, and *n* have values as in the example above, compute:

```

var  r, n, nn, four, years, rate, PV, FV : Extended;
     f : DecForm;
     s : DecStr;
    ...

with f do begin
  style := FIXEDDECIMAL;
  digits := 2
end;

IZX (15000, FV);      { FV ← 15000.00          }
nn := n;
NegX (nn);           { nn ← -n                }

Compound (r, nn, PV); { PV ← (1 + r)^-n        }
MulX (FV, PV);       { PV ← FV * (1 + r)^-n      }

X2Str (f, PV, s);    { f is FIXED with 2 fraction digits. }
writeln ('PV = $', s);

```

The present value *PV* is \$ 8793.70.

The present value and future value of an annuity can be computed using

```
procedure Annuity (r, n : Extended; var x : Extended);
```

This procedure computes the value

$$x = \frac{1 - (1 + r)^{-n}}{r},$$

where *r* is the interest rate and *n* is the number of periods.

*Example*

Suppose that a loan at 12% compounded monthly is to be paid off at a rate of \$225 per month in 36 months. What is the present value of the loan? Compute:

```

var  r, n, twelve, rate, PV, PMT : Extended;
     f : DecForm;
     s : DecStr;
    ...

```

```

with f do begin
  style := FIXEDDECIMAL;
  digits := 2
end;

IZX (12, twelve);      { twelve ← 12 }
StrZX ('0.12', rate); { rate ← 12% }
StrZX ('36', n);      { n ← 36 }
IZX (225, PMT);       { PMT ← 225.00 }

r := rate;
DivX (twelve, r);     { r ← rate / 12 }

Annuity (r, n, PV);   { PV ← (1 - (1 + r)-n) / r }
MulX (PMT, PV);      { PV ← PMT * (1 - (1 + r)-n) / r }

X2Str (f, PV, s);    { f is FIXED with 2 fraction digits. }
writeln ('PV = $', s);

```

The present value PV is \$ 6774.19.

#### Example

If \$50 is deposited each month to a savings account that pays 12% compounded monthly, what is the future value of the account after 10 years? Compute

```

var  r, n, twelve, rate, years, FV, PMT, t : Extended;
     f : DecForm;
     s : DecStr;
     ...

with f do begin
  style := FIXEDDECIMAL;
  digits := 2
end;

IZX (12, twelve);      { twelve ← 12 }
StrZX ('0.12', rate); { rate ← 12% }
IZX (10, years);      { years ← 10 }
IZX (50, PMT);       { PMT ← 50.00 }

r := rate;
DivX (twelve, r);     { r ← rate / 12 }
n := years;
MulX (twelve, n);    { n ← years * 12 }

```



```

Compound (r, n, t);      { t ← (1 + r)n }
Annuity (r, n, FV);     { FV ← (1 - (1 + r)-n) / r }
MulX (t, FV);           { FV ← ((1 + r)n - 1) / r }
MulX (PMT, FV);        { FV ← PMT * ((1 + r)n - 1) / r }

XZStr (f, FV, s);      { f is FIXED with 2 fraction digits. }
writeln ('FV = $', s);

```

The final value FV is \$ 11501.93.

#### D.3.10.4 Trigonometric Functions

The trigonometric functions are provided by the procedures CosX, SinX, TanX, and ATanX (arctangent or inverse tangent), which operate on an Extended variable and return the result in the input argument.

The cosine is computed by

```
procedure CosX (var x : Extended);
```

The sine is computed by

```
procedure SinX (var x : Extended);
```

The tangent is computed by

```
procedure TanX (var x : Extended);
```

The arctangent is computed by

```
procedure ATanX (var x : Extended);
```

#### D.3.10.5 Random Number Generator

Pseudorandom numbers are provided by

```
procedure RandomX (var x : Extended);
```

RandomX uses the iteration formula

$$x = (75 * x) \bmod (2^{31} - 1)$$

A sequence of pseudorandom integral values  $r$  in the range

$$1 \leq r \leq 2^{31} - 2$$

can be generated by initializing an Extended variable  $r$  to an integral value (the seed) in the range and making repeated calls RandomX ( $r$ ); each call delivers in  $r$  the next pseudorandom number in the sequence.

If seed values of  $r$  are nonintegral or outside the range

$$1 \leq r \leq 2^{31} - 2$$

then results are unspecified.

*Example*

A procedure yielding a pseudorandom rectangular distribution on (0, 1):

Exterior to the procedure declare and initialize

```

const  SEED = 1018375230  { arbitrary seed      }

var    P, one, r: Extended;

begin
  IZX (1, one);           { one ← 1          }
  P := one;               { P ← 1          }
  ScalbX (31, P);        { P ← 231       }
  SubX (one, P);         { P ← 231 - 1   }

  LZ (SEED, r);          { r ← SEED      }
  . . .

```

The desired procedure can be written

```

procedure Rand (var x : Extended);
begin
  RandomX (r);           { r ← random int value }
  x := r;                { x ← r               }
  DivX (P, x)            { normalize to (0, 1)  }
end;

```

## D.3.11 Additional FPLib Procedures

```

Function SANE_Enviro : longint ;           { Internal use only. }
Procedure InitFPLib ;                     { Initializes FPLib. }
Function GetHltAddress : longint ;        { Returns halt address. }
Procedure SetHltAddress ( HltAddress : longint ) ; { Sets halt address. }

```

SANE\_Enviro is for internal use of other FPLib procedures.

InitFPLib resets the environment and the halt address to default values.

This initialization occurs automatically at the beginning of the outer block of a Pascal main program. InitFPLib may be called later to reestablish default conditions if desired.

The halt address is the address to which control passes when a floating-point halt occurs, as described in detail in *The 68000 Assembly-Language SANE Engine*. GetHltAddress and SetHltAddress may be used to obtain the halt address. SetHltAddress may be used to change the halt address to the entry point of a halt-handling procedure.

The following demonstrates a sample halt procedure:

```

type miscrec = record
    halterrors : integer;
    ccrpending : integer;
    dopending : longint;
end;

procedure haltroutine
    ( var misc : miscrec;
      src2, src, dst : longint;
      opcode : integer );

    (* Prints out the op word and address parameters of the floating-
    point operation that halted, then displays the name of each
    exception that occurred in that operation and whose halt was
    enabled. After perusing this information, the user presses
    RETURN to continue execution as if no halt had occurred. *)

var env : Environ ;
    x : Exception ;

begin (* haltroutine *)
    ProcEntry(env) ;
    writeln(' Floating point halt taken on op code ', opcode) ;
    writeln(' Destination address ', dst ) ;
    writeln(' Source address ', src ) ;
    writeln(' 2nd Source address ', src2 ) ;
    write(' Exceptions signaled with enabled halts : ) ;
    SetEnv(misc.halterrors) ;
    for x := INVALID to INEXACT do if TestHlt(x) then case x of
        INVALID : write(' Invalid ' ) ;
        UNDERFLOW : write(' Underflow ' ) ;
        OVERFLOW : write(' Overflow ' ) ;
        DIVBYZERO : write(' DivByZero ' ) ;
        INEXACT : write(' Inexact ' ) ;
    end (* case x *) ;
    writeln ;
    writeln(' Press RETURN to continue. ' ) ;
    readln ;
    ProcExit(env) ;
end (* haltroutine *) ;

..... (* Elsewhere in the program ... *)

(* This code is executed prior to the floating-point operations for
which the halts are to be enabled. Oldhltaddress is
declared to be a longint. *)

```

```
oldhaltaddress := GetHltAddress ; (* Save old halt address. *)  
SetHltAddress( ord4(@haltroutine) ) ; (* Set new halt address to go to  
                                       haltroutine. *)
```

```
    (* Enable halts on 'severe' exceptions. *)
```

```
SetHlt( INVALID, TRUE ) ;  
SetHlt( OVERFLOW, TRUE ) ;  
SetHlt( DIVBYZERO, TRUE ) ;
```

```
    (* If any of these three exceptions subsequently occur, control  
       will pass through haltroutine. *)
```

## D.3.12 FPLib Interface

```
UNIT FPLib ; INTRINSIC ;
```

```
INTERFACE
```

```
{ Lisa Floating Point Library. }
```

```
{ $C Copyright 1983, 1984, Apple Computer Inc. }
```

```
CONST
```

```
{ SANE: Standard Apple Numeric Environment }
```

```
{ Comments like !A// denote differences from the Apple // and /// SANE unit interface. }
```

```
SIGDIGLEN = 20;      { Maximum length of SigDig. !A//: 28 }
```

```
DECSTRLEN = 255;    { Maximum length of DecStr. !A//: 80 }
```

```
TYPE
```

```
{-----  
** Numeric types.  
-----}
```

```
Single   = real; { !A//: array [0..1] of integer }  
Double   = array [0..3] of integer;  
Comp     = array [0..3] of integer;  
Extended = array [0..4] of integer;
```

```
{-----  
** Decimal string type and intermediate decimal type,  
** representing the value:  
**       $(-1)^{\text{sgn}} * 10^{\text{exp}} * \text{sig}$   
-----}
```

```
SigDig   = string [SIGDIGLEN];
```

```
DecStr   = string [DECSTRLEN];
```

```
Decimal  = record
```

```
    sgn : 0..1;      { Sign (0 for pos, 1 for neg). }
```

```
    exp : integer;  { Exponent. }
```

```
    sig : SigDig    { String of significant digits. }
```

```
end;
```

```

-----
** Modes, flags, and selections.
** NOTE: the values of the style element of the DecForm record
** have different names from the Apple // and /// version to
** avoid name conflicts.
-----

```

```

    Environ    = integer ;
    RoundDir   = (TONEAREST, UPWARD, DOWNWARD, TOWARDZERO);
    RelOp      = (GT, LT, GL, EQ, GE, LE, GEL, UNORD);
               { > < <> = >= <= <=> }
    Exception  = (INVALID, UNDERFLOW, OVERFLOW, DIVBYZERO, INEXACT);
    NumClass   = (SNAN, QNAN, INFINITE, ZERO, NORMAL, DENORMAL);
    DecForm    = record
        style   : (FLOATDECIMAL, FIXEDDECIMAL);
               { !A//: FLOAT, FIXED }
        digits  : integer
    end;

```

```

-----
** Two address, extended-based arithmetic operations.
-----

```

```

procedure AddS (x : Single;   var y : Extended);
procedure AddD (x : Double;   var y : Extended);
procedure AddC (x : Comp;     var y : Extended);
procedure AddX (x : Extended; var y : Extended);
    { y := y + x }

procedure SubS (x : Single;   var y : Extended);
procedure SubD (x : Double;   var y : Extended);
procedure SubC (x : Comp;     var y : Extended);
procedure SubX (x : Extended; var y : Extended);
    { y := y - x }

procedure MulS (x : Single;   var y : Extended);
procedure MulD (x : Double;   var y : Extended);
procedure MulC (x : Comp;     var y : Extended);
procedure MulX (x : Extended; var y : Extended);
    { y := y * x }

procedure DivS (x : Single;   var y : Extended);
procedure DivD (x : Double;   var y : Extended);
procedure DivC (x : Comp;     var y : Extended);

```

```

procedure DivX (x : Extended; var y : Extended);
  { y := y / x }

function CmpX (x : Extended; r : RelOp; y : Extended) : boolean;
  { CmpX := x r y }

function RelX (x, y : Extended) : RelOp;
  { x RelX y, where RelX in [GT, LT, EQ, UNORD] }

-----
** Conversions between Extended and the other numeric types,
** including the types integer and longint.
-----

procedure I2X (x : integer; var y : Extended);
procedure S2X (x : Single; var y : Extended);
procedure D2X (x : Double; var y : Extended);
procedure C2X (x : Comp; var y : Extended);
procedure X2X (x : Extended; var y : Extended);
  { y := x (arithmetic assignment) }

procedure X2I (x : Extended; var y : integer);
procedure X2S (x : Extended; var y : Single);
procedure X2D (x : Extended; var y : Double);
procedure X2C (x : Extended; var y : Comp);
  { y := x (arithmetic assignment) }

-----
** !These conversions are not in the Apple // & /// SANE unit.
-----

procedure L2X (x : longint; var y : Extended);
procedure X2L (x : Extended; var y : longint);
  { y := x (arithmetic assignment) }

-----
** Conversions between the numeric types and the intermediate
** decimal type.
-----

procedure S2Dec (f : DecForm; x : Single; var y : Decimal);
procedure D2Dec (f : DecForm; x : Double; var y : Decimal);
procedure C2Dec (f : DecForm; x : Comp; var y : Decimal);
procedure X2Dec (f : DecForm; x : Extended; var y : Decimal);
  { y := x (according to the format f) }

procedure Dec2S (x : Decimal; var y : Single);

```

```

procedure Dec2D (x : Decimal; var y : Double);
procedure Dec2C (x : Decimal; var y : Comp);
procedure Dec2X (x : Decimal; var y : Extended);
    { y := x }

```

```

-----
** Conversions between strings and the intermediate decimal type.
-----

```

```

procedure Str2Dec (s : DecStr; var index : integer;
    var d : Decimal ; var ValidPrefix : boolean );

    { d := s, starting at s[index]; on output index points to
      first character past accepted token; ValidPrefix is
      true if the token, concatenated with the characters
      following it, is a valid prefix of a numeric token. }

```

```

procedure Dec2Str (f: DecForm; d: Decimal; var s: DecStr);
    { s := d (according to the format f) }

```

```

-----
** Conversions between the numeric types and strings.
-----

```

```

procedure S2Str (f : DecForm; x : Single;    var y : DecStr);
procedure D2Str (f : DecForm; x : Double;    var y : DecStr);
procedure C2Str (f : DecForm; x : Comp;      var y : DecStr);
procedure X2Str (f : DecForm; x : Extended;  var y : DecStr);
    { y := x (according to the format f) }

```

```

procedure Str2S (x : DecStr; var y : Single);
procedure Str2D (x : DecStr; var y : Double);
procedure Str2C (x : DecStr; var y : Comp);
procedure Str2X (x : DecStr; var y : Extended);
    { y := x }

```

```

-----
** Numerical 'library' procedures and functions.
-----

```

```

procedure RemX    (x : Extended; var y : Extended;
    var quo : integer);
    { (new y) := (old y) - x * n, where n is the integer closest
      to y/x; n is even in case of tie.
      quo := low order seven bits of integer quotient y / x,
      so that -127 <= quo <= 127. }

```



```

procedure SqrtX (var x : Extended);
  { x := sqrt (x) }
procedure RintX (var x : Extended);
  { x := rounded to integral value of x }
procedure NegX (var x : Extended);
  { x := -x }
procedure AbsX (var x : Extended);
  { x := |x| }
procedure CpySgnX (var x : Extended; y : Extended);
  { x := x with the sign of y }

procedure NextS (var x : Single; y : Single);

procedure NextD (var x : Double; y : Double);
procedure NextX (var x : Extended; y : Extended);
  { x := next representable value from x toward y }

function ClassS (x : Single; var sgn : integer) : NumClass;
function ClassD (x : Double; var sgn : integer) : NumClass;
function ClassC (x : Comp; var sgn : integer) : NumClass;
function ClassX (x : Extended; var sgn : integer) : NumClass;
  { sgn := sign of x (0 for pos, 1 for neg) }

procedure ScalbX (n : integer; var y : Extended);
  { y := y * 2^n }
procedure LogbX (var x : Extended);
  { returns unbiased exponent of x }

{-----}
** Manipulations of the static numeric state.
{-----}

procedure SetRnd (r : RoundDir);
procedure SetEnv (e : Environ);

function GetRnd : RoundDir;
procedure GetEnv (var e : Environ);

function TestXcp (x : Exception) : boolean;
procedure SetXcp (x : Exception; OnOff : boolean);
function TestHlt (x : Exception) : boolean;
procedure SetHlt (x : Exception; OnOff : boolean);

```

```

-----
** ! Lisa and Mac only.
-----
}

{ Procedures to Get and Set Extended Rounding Precision are in Mathlib

procedure ProcEntry (var e : Environ); { Procedure entry protocol.}
procedure ProcExit(e : Environ);      { Procedure exit protocol. }

-----
}

{ ELEMS: Elementary Functions. }

procedure Log2X (var x : Extended);
  { x := log2 (x) }

procedure LnX (var x : Extended);
  { x := ln (x) }

procedure Ln1X (var x : Extended);
  { x := ln (1 + x) }

procedure Exp2X (var x : Extended);
  { x := 2^x }

procedure ExpX (var x : Extended);
  { x := e^x }

procedure Exp1X (var x : Extended);
  { x := e^x - 1 }

procedure XpwrI (i : integer; var x : Extended);
  { x := x^i }

procedure XpwrY (y : Extended; var x : Extended);
  { x := x^y }

procedure Compound (r, n : Extended; var x : Extended);
  { x := (1 + r)^n }

procedure Annuity (r, n : Extended; var x : Extended);
  { x := (1 - (1 + r)^-n) / r }

procedure AtanX (var x : Extended);
  { x := atan(x) }

```

```
procedure SinX (var x : Extended);
  { x := sin(x) }

procedure CosX (var x : Extended);
  { x := cos(x) }

procedure TanX (var x : Extended);
  { x := tan(x) }

procedure RandomX (var x : Extended);
  { x := (7^5 * x) mod (2^31 - 1) }

{-----}

  { Procedures for Lisa and Mac only. }

function GetHltAddress : longint ;           { Returns halt address. }
procedure SetHltAddress ( HltAddress : longint ) ; { Sets halt address. }
procedure InitFPLib ;                       { Initializes FPLib. }
function SANE_Environ : longint ;          { Internal use only. }

{-----}
```

**D.4 MathLib**

The intrinsic unit MathLib, contained in the file IOSFPLib, contains procedures in the following areas:

- Environment Procedures.
- Elementary Functions.
- Utility Procedures.
- Sorting.
- Free-Format Conversion to ASCII.
- Correctly Rounded Conversion between Binary and Decimal.
- Financial Analysis.
- Zeros of Functions.
- Linear Algebra.

**D.4.1 How to Use MathLib**

MathLib is a Lisa intrinsic unit. Thus it may be conveniently used by Pascal programmers. MathLib procedures may also be used by assembly-language programmers who observe the Pascal conventions for data structures and procedure calls.

When writing Pascal source code, include a USES statement such as:

```
USES FPLib, MathLib ;
```

after the program statement in a main program or after the interface statement in a unit. If you are also using other units, include FPLib and MathLib in the list of units in your one USES statement. They may be listed before or after other units you are using, but FPLib must appear in the list before MathLib.

**D.4.2 Environment Procedures**

```
Type RoundPrecision = ( ExtPrecision, DblPrecision, RealPrecision ) ;

Procedure SetPrecision ( p : RoundPrecision ) ;
    { Set rounding precision. }
Function GetPrecision : RoundPrecision ;
    { Get rounding precision. }
Procedure ClearXcps ;
    { Turn off all exception flags. }
Procedure ClearHlts ;
    { Disable all halts. }
```

The environmental control procedures in MathLib supplement those in FPLib. They work on the global floating-point environment.

ClearXcps turns off all the exception flags at once. It is faster than the equivalent code:

```
for e := INVALID to INEXACT do SetXcp( e, FALSE ) ;
```

In the same way, ClearHlts disables all the halts at once.

The MathLib type RoundPrecision defines the possible settings of the rounding precision mode. The procedures SetPrecision and GetPrecision are used with RoundPrecision in the same way that SetRnd and GetRnd are used with RoundDir.

Rounding precision is usually used to simulate single-only or double-only arithmetic on a system which uses extended-precision expression evaluation. Thus to simulate

```
z := x * y ;
```

as it would occur in a double-only system, the following suffices:

```
savepre := GetPrecision ; { Savepre of type RoundPrecision. }
SetPrecision( DblPrecision ) ;
DZX( x, xx ) ;
AddD( y, xx ) ;
XZD( xx, z ) ;
SetPrecision( savepre ) ;
```

In this example the rounding precision affects only the AddD operation. The extended result xx is rounded as if the final destination were double precision, with inexact, underflow, and overflow signalled accordingly. The XZD operation will then raise no further exception.

### D.4.3 Elementary Functions

```
Const RandModulus = 2147483647 ;
      { Prime modulus for random number generation = 231-1. }
```

```
Function NextRandom ( lastrandom : longint ) : longint ;
      { Returns next 'random' longint with 1 <= nextrandom <=
        RandModulus-1. }
```

```
Procedure ASinX ( var x : Extended ) ; { x := asin(x) }
Procedure ACosX ( var x : Extended ) ; { x := acos(x) }
```

```
Procedure SinhX ( var x : Extended ) ; { x := sinh(x) }
Procedure CoshX ( var x : Extended ) ; { x := cosh(x) }
Procedure TanhX ( var x : Extended ) ; { x := tanh(x) }
```

```
Procedure AbsZX ( x, y : Extended ; var z : Extended ) ; { z := abs(y+ix) }
Procedure ATanZX( x, y : Extended ; var z : Extended ) ; { z := arg(y+ix) }
```

FPLib provides the procedure RandomX which operates on an extended argument. A valid argument for RandomX is an integral value between 1 and  $2^{31}-2$ , and RandomX replaces a valid argument with the next such valid argument. MathLib provides a more efficient function NextRandom, which operates on and returns longints. The following is equivalent to

RandomX( x ) for valid arguments x:

```
X2L( x, lx ) ;
LX := NextRandom ( lx ) ;
L2X( lx, x ) ;
```

NextRandom uses integer rather than floating-point arithmetic and thus is faster. The result of supplying an invalid argument to NextRandom is undefined.

The constant RandModulus can be used as in either of the following examples to produce an array of numbers distributed uniformly strictly between 0 and 1:

```
L2X( RandModulus, XRandModulus ) ;
I2X( 1234, r ) ;
for i := 1 to n do begin
  RandomX( r ) ;
  t := r ;
  DivX( XRandModulus, t ) ;
  a[i] := t ;
end ;
```

OR

```
L2X( RandModulus, XRandModulus ) ;
lr := 1234 ;
for i := 1 to n do begin
  lr := NextRandom( lr ) ;
  L2X( lr, t ) ;
  DivX( xRandModulus, t ) ;
  a[i] := t ;
end ;
```

The elementary functions ASinX, ACosX, SinhX, CoshX, and TanhX provide inverse sine and cosine, and hyperbolic sine, cosine, and tangent. Arguments in the interval  $[-1, +1]$  are valid for inverse sine and cosine; for these arguments, ASinX returns a value in  $[-\pi/2, +\pi/2]$  while ACosX returns a value in  $[+0, +\pi]$ ; the NaN for inverse trigonometric functions is returned for other arguments. The hyperbolic sine, cosine, and tangent are defined for all arguments, but SinhX and CoshX signal overflow for large arguments.

Abs2X and ATan2X are provided to facilitate coordinate conversion. Abs2x computes the square root of the sum of squares of its arguments; ATan2x computes the angle between a point (x, y) and the positive x-axis. ATan2x returns a number in  $[-\pi, +\pi]$ , even if x or y is zero or infinite.

To convert from rectangular coordinates (x, y) to polar coordinates (r, t) :

```
Abs2X( y, x, r ) ;
ATan2X( y, x, t ) ;
```

To convert back to rectangular coordinates:

```
x := t ; y := t ;
CosX ( x ) ; SinX ( y ) ;
MulX ( r, x ) ; MulX( r, y ) ;
```

#### D.4.4 Utility Procedures

```
Type FP_Type = ( TFP_byte, TFP_integer, TFP_longint, TFP_Comp, TFP_real,
                 TFP_Double, TFP_Extended ) ;
                { Number type names for FP_size. }
```

```
Procedure FP_Size ( x: Extended ; var sgn: integer ; var class: NumClass ;
                  var size: FP_Type ) ;
                { Returns sign bit, class, and size of smallest type that
                  would hold x exactly. }
```

```
Function SignOfX ( x : Extended ) : boolean ; { True if x has neg sign. }
```

```
Function FP_New ( n : longint ) : longint ;
                { Attempts to allocate n bytes on heap, returning address.
                  Returns ord4(nil) if space not available. }
```

The utility procedures simplify common programming tasks. SignOfX returns TRUE if x has negative sign, and FALSE if x has positive sign. Remember that zero, infinity, and NaN have sign bits too. The following are equivalent but the first is more efficient if only the sign is of interest:

```
if SignOfX ( x ) then ...
```

OR

```
c := ClassX ( x, sgn ) ;
if sgn = 1 then ...
```

FP\_Size tells the smallest storage type that can contain the value of x, and as a side benefit returns the class of x and its sign in the same format that ClassX uses. If x contains an integral value that can be contained in a Comp variable, then FP\_Size will return TFP\_byte, TFP\_integer, TFP\_longint, or TFP\_comp if the smallest integral container that will contain x is a byte -128..+127, an integer, a longint, or a comp, respectively. Otherwise FP\_Size will return TFP\_real, TFP\_double, or TFP\_extended if the smallest floating-point container that will contain x is real, double, or extended, respectively. Thus the size of positive zero is TFP\_byte, of negative zero is TFP\_real, of infinity is TFP\_real, of denormal is TFP\_extended, and of NaN is always one of the floating-point sizes.

FP\_New is a shortcut way to allocate a number of bytes on the Pascal heap without specifying the data structure to be placed there. It is used internally in MathLib to implement temporary arrays needed by the sorting and linear algebra procedures, but it is also useful for allocating space for other dynamic storage structures. The number of bytes to be allocated is specified by a longint argument and thus can be as large as desired, although the Lisa Pascal heap will rarely have more than about 600000 bytes available. If the requested space is available, then FP\_New returns the address of the first byte of the allocated storage; if not available then FP\_New returns ord4(nil). For instance, to allocate an array of 10000 double precision, do the following:

```
const DOUBLESIZE = 8 ; { 8 = SizeOf(Double) }

dpa := FP_New( ord4(10000) * DOUBLESIZE ) ;
if dpa = ord4(nil) then { error } else { ok }
```

Assuming the array is to be indexed from 0 to 9999, to access element k:

```
type pd = ^ Double ;

pd := pointer( dpa + ord4(k) * DOUBLESIZE ) ;
ak := pd^ ;
```

Just as in using the built-in Pascal procedure new, appropriate use of mark and release allows reuse of heap space: use mark(p) just before calling FP\_New, and then release(p) when that and any other heap space subsequently allocated with new or FP\_New is no longer in use.

#### D.4.5 Sorting

```
Procedure Math_Sort ( { General procedure to stably sort an arbitrary list. }
  first, last : integer ; { Records first..last will be sorted. }
  Function Sorted ( i, j : integer ) : boolean ;
    { User-supplied procedure called by Math_Sort to compare order of
      records i and j. Math_sort guarantees first <= i < j <= last.
      Sorted returns true if records i and j are already correctly
      sorted with respect to each other. }
  Procedure Swap ( i, j : integer ) ;
    { User-supplied procedure called by Math_Sort to swap records i
      and j. Math_sort guarantees first <= i < j <= last. }
  Var error : boolean ) ; { True if sort routine failed due to
                           insufficient heap space available. }
```



Math\_Sort is a generalized merge sorting procedure. It has no knowledge of the structure of the records being sorted; it obtains the information it needs through the user-supplied procedures Sorted and Swap. Math\_Sort only calls Sorted and Swap with  $i$  and  $j$  satisfying first  $\leq i < j \leq$  last.

Math\_Sort contains two phases: sorting and swapping. To sort  $n$  records, the number of calls of Sorted is proportional to  $n \cdot \log(n)$ . The number of calls of Swap is at most  $n-1$ .

The algorithm is *stable*: If prior to the sort, two records  $i$  followed by  $j$  are correctly ordered with respect to each other, then after the sort, the record that was originally at  $i$  will still be followed by the record that was originally at  $j$ . This is true even if Sorted( $i, j$ ) and Sorted( $j, i$ ) are true, as might happen if Sorted were implemented by a comparison like 'key[i] <= key[j]'.

Internally, Math\_Sort creates and disposes of a temporary array on the Pascal heap of size  $4 * (\text{last} - \text{first} + 1)$  bytes. If there is insufficient heap space available then error will be set TRUE and no sorting will be done.

The following sorting example is based on an array of 1000 records containing a primary key, which is a double precision number, and a secondary key, which is binary. For this example, records with NaN keys are to go to the end of the list.

```

type srec = record
    key : Double ;
    subkey : 0..1 ;
    ...
end ;

var a : array [1..1000] of srec ;

function sreccsorted ( i, j : integer ) ; (* User Sorted function. *)

    var ki, kj : Extended ;

begin (* sreccsorted *)
    DZX( a[i].key, ki ) ;
    DZX( a[j].key, kj ) ;
    case RelX( ki, kj ) of
        LT : sreccsorted := TRUE ;
        GT : sreccsorted := FALSE ;
        EQ : sreccsorted := a[i].subkey <= a[j].subkey ;
        UNORD : sreccsorted := ClassX( ki, sgn ) <= ClassX( kj, sgn ) ;
    end (* case *) ;
end (* sreccsorted *) ;

procedure sreccswap ( i, j : integer ) ; (* User Swap function. *)

```

```

var t : srec ;

begin (* srecswap *)
  t := a[i] ;
  a[i] := a[j] ;
  a[j] := t ;
end (* srecswap *) ;

... (* In the user's main program... *)

Math_Sort( 1, 1000, srecsorted, srecswap, error ) ;
if error then { not enough heap space } else { sorted OK }

```

#### D.4.6 Free Format Conversion to ASCII

```

Type Free_Format = record      { Specifications for free-form output.      }
  MaxSig : integer ;          { Maximum number of significant digits.    }
  Sig_FForm,                  { True if "fixed" style applies MaxSig to }
                              { significant digits; false if to digits }
                              { after the point.                          }
  Trail_Point,               { True if trailing point should be printed }
                              { for inexact values in "integral" style.  }
  Int_EForm,                 { True if "exponential" style acceptable for }
                              { integral values.                          }
  Plus_EForm : boolean ;     { True if "exponential" style should exhibit }
                              { + sign for positive exponents.          }
end ;

Procedure FP_Free_ASCII (      { Procedure to provide free form ASCII output. }
  x : Extended ;              { Number to be converted from binary to ASCII. }
  Width : integer ;           { Maximum number of characters in output string. }
  form : Free_Format ;        { Detailed format specifications.              }
  var s : Decstr ) ;          { Output destination string. If, after call, }
                              { length(s) > Width, then x was inconsistent with }
                              { the constraints Width or MaxSig.          }

```

FP\_Free\_ASCII provides a solution to the following problem: Given a number to be displayed in ASCII in a fixed field width, choose an ASCII format that displays as much information about the number as possible with as few ASCII characters as possible, not exceeding the fixed field width unless absolutely necessary.

Thus the number one should be displayed as '1' and not '1.0' or '1e0'. Positive zero should appear as '0' and not '0.000e-0'. Pi, to be displayed in columns of width 1, 5, 10, and 15, should appear as '3', '3.142', '3.14159265', '3.1415926535898'.  $-0.00001$  should appear as  $-1E-5$  unless Width  $\geq 7$ , in which case  $-.00001$  should appear.

The following special cases are formatted strictly according to Width:

For positive zero,  $s := '0'$ ; for negative zero,  $s := '-0'$  unless Width  $\leq 1$ , in which case  $s := '0'$ .

For positive infinity,  $s := 'Inf'$ ; for negative infinity,  $s := '-Inf'$ .

For NaNs,  $s$  will have the value that X2Str would return, unless that would exceed Width; then  $s := 'NaN'$  or  $-'NaN'$  depending on the sign bit, unless Width  $\leq 3$ ; then  $s := 'NaN'$  regardless of sign.

The essential method for formatting normal numbers is to first attempt a representation with *integral* format, then with a *fixed* decimal point format, and then with an *exponential* format with a minimal number of decimal digits in the exponent. (FORTRAN programmers are familiar with these as I, F, and E formats, respectively.) At each stage, a representation is rejected if it would require more than Width ASCII characters to represent the number according to the specifications in the Free\_Format record.

The number of significant digits never exceeds 19 and may be further limited by MaxSig.

*Integral* format is attempted only if  $x$  contains a value that would fit exactly in a Comp. The integral format of ten billion is 1000000000, but 3.14, not being an integral value, is not displayed in integral format. When the Free\_Format field Int\_EForm is true, then numbers like ten billion are shortened to 1E10 by converting three or more trailing zeros to an E and exponent.

A string in *fixed* decimal point format might look like '123.456' or '.00000000000234565'. MaxSig specifies the maximum number of digits that will be displayed. Sig\_FForm determines how MaxSig is applied. If Sig\_FForm is TRUE then there will be no more than MaxSig *significant* digits. Significant digits are counted from the first nonzero digit to the last nonzero digit. Thus 123456000000., 123.456, and .0000000000123456 all have six significant digits. If Sig\_FForm is FALSE then there will be no more than MaxSig digits *after the point*. Thus 1000000000000.123456, .123456, and .000001 all have six digits after the point.

After rounding to the specified number of decimal digits, which may be reduced to fit in *Width*, trailing zeros after the point are ignored. Thus if the number, rounded to six digits after the point, was 123.456000, the last three zeros would be deleted. Sometimes all the digits after the point might be removed, as in the case of 123.000000, which would be truncated to '123.'. Whether a trailing point is retained is determined by the *Free\_Format* field *Trail\_Point*: if TRUE, then *s* := '123.'; if FALSE, *s* := '123'. Note that the original value of *x* in this example could not have been 123 exactly; *x* would then have been displayed as '123' in *integral* format. Instead it might have been 123.000000000000001 before rounding to six digits after the point.

Finally *exponential* format is tried. *MaxSig* specifies the maximum number of significant digits to be displayed. If *x* is ten billion, then the *exponential* display will depend on the specification as follows:

<u>Trail_Point:</u>	<u>Plus_EForm:</u>	<u>String:</u>
False	False	1E10
True	False	1.E10
False	True	1E+10
True	True	1.E+10

When a single- or double-precision number is converted to extended and then converted to ASCII in free format with no more than 18 significant digits, then the ASCII string will satisfy the requirements of the IEEE Standard. But a free form string that, for instance, displays 12 digits in *exponential* format, may differ by one in the last digit from the string that would be obtained by calling *S2Str* or *D2Str* with *form* = *FLOATDECIMAL* and *digits* = 12. Both strings satisfy the IEEE Standard; a difference may only arise in the extreme exponent cases for which the Standard allows more than one possible result for conversion from binary to decimal.

Denormal *x* is always represented in *exponential* form with four exponent digits.

In LisaCalc, the default formatting conventions are *MaxSig* = 14, *Trail\_point* = FALSE, *Int\_EForm* = FALSE, *Plus\_EForm* = FALSE. *Sig\_FForm* is set FALSE for numbers less than one in magnitude, and TRUE otherwise.

*Examples:*

```

MaxSig      = 19
Sig_FForm   = TRUE
Trail_Point = TRUE
Int_EForm   = TRUE
Plus_EForm  = FALSE

```

Input = 1234567890.0123456789

Width	String
>= 20	'1234567890.012345678'
19	'1234567890.01234568'
18	'1234567890.0123457'
17	'1234567890.012346'
16	'1234567890.01235'
15	'1234567890.0123'
14	'1234567890.012'
13	'1234567890.01'
12	'1234567890.'
11	'1234567890.'
10	'1.234568E9'
9	'1.23457E9'
8	'1.2346E9'
7	'1.235E9'
6	'1.23E9'
5	'1.2E9'
<= 4	'1.E9'

Input = .00001234

>= 25	'0.00001233999999999999999'
23..24	'1.233999999999999999E-5'
8..22	'1.234E-5'
7	'1.23E-5'
6	'1.2E-5'
<= 5	'1.E-5'

Input = -6.023e-23

>= 25	'-6.022999999999999999E-23'
10..24	'-6.023E-23'
9	'-6.02E-23'
8	'-6.E-23'
<= 7	'-6.E-23'

**D.4.7 Correctly Rounded Conversion Between Binary and Decimal**

```

Const LSigDigLen = 30 ;    { Length of significand string. }

Type LongSigDig = string[LSigDigLen] ;

   LongDecimal = record
       sgn : 0..1 ;
       exp : integer ;
       sig : LongSigDig ;
   end ;

Procedure X2LDec ( f : DecForm ; x : Extended ; var y : LongDecimal ) ;
   { Converts x to y, correctly rounded according to f. }

Procedure LDec2X ( prec: RoundPrecision; x: LongDecimal; var y: Extended ) ;
   { Converts x to y, correctly rounded according to prec. }

```

The procedures X2LDec and LDec2X correspond to X2Dec and Dec2X, and work similarly, only more accurately and much more slowly. The IEEE Standard does not require correctly rounded conversion for single- and double-precision numbers for extremely large and small exponents, and does not specify conversion at all for extended-precision numbers. The results returned by Dec2S, S2Dec, Dec2D, and D2Dec may differ by one unit in the least significant bit or digit from the correctly rounded results, while the results returned by Dec2X and X2Dec may differ by more than one unit from the correctly rounded results.

The correctly rounded conversion routines accept or produce up to 30 decimal digits. X2LDec produces correctly rounded LongDecimal records according to its DecForm parameter. To obtain correctly rounded results from Single, Double, or Extended arguments, use one of the sequences:

```

   SZX( s, x ) ;
   X2LDec( f, x, y ) ;

OR

   DZX( d, x ) ;
   X2LDec( f, x, y ) ;

OR

   X2LDec( f, x, y ) ;

```

LDec2X rounds correctly according to its RoundPrecision parameter. To obtain correctly rounded single, double, or extended results, use one of the sequences:

```
LDec2X( REALPRECISION, x, y );
X2S( y, s );
```

OR

```
LDec2X( DBLPRECISION, x, y );
X2D( y, d );
```

OR

```
LDec2X( EXTPRECISION, x, y );
```

No correctly rounded conversions to DecStr strings are provided, but the routines Str2Dec and Dec2Str may be tricked to apply to LongDecimal arguments. To convert a DecStr x with no more than 19 significant digits to a correctly rounded Extended y, do:

```
var t : Decimal ;
    pd : ^ LongDecimal ;

index := 1 ;
Str2Dec( x, index, t, ValidPrefix ) ;
pd := pointer ( ord4( @t ) ) ;
LDec2X( EXTPRECISION, pd^, y ) ;
```

and to convert an Extended x to a string y correctly, do:

```
var t : LongDecimal ;
    pd : ^ Decimal ;

X2LDec( f, x, t ) ;
pd := pointer ( ord4( @t ) ) ;
Dec2Str ( f, pd^, y ) ;
```

X2LDec sets the inexact flag appropriately. LDec2X sets the inexact, underflow, and overflow flags appropriately.

The time required to convert correctly rounded is proportional to the square of the exponent. The most extreme double precision numbers take a few seconds, but extendeds with very large or small exponents require up to twenty minutes. Thus these routines are too slow to use habitually for converting the full range of extended-precision numbers; use these routines for applications such as obtaining the best possible approximations to tabulated values of mathematical constants such as pi or e.

#### D.4.8 Financial Analysis

```
Procedure Fin_Npv      (      { Compute net value of series of payments. }
    first,             { First payment period. }
    last,              { Last payment period. }
```

```

net : integer ;      { Period at which net value is to be
                    { computed; need not be between first and
                    { last. }
rate  : Extended ;  { Periodic interest rate. }
var Npv : Extended ; { Net payment value. }
Procedure payment ( i : integer ; var pmt : Extended )
    { User-supplied procedure to provide pmt, the payment at
    { period i. }
    { Fin_Npv guarantees first <= i <= last. }
);

Procedure Fin_Return ( { Analyze series of payments for external or
                    { internal rate of return. Discounting by
                    { external rates may be specified for positive or
                    { negative payments or both or neither. Standard
                    { internal rate of return is obtained by
                    { specifying, for example, negperiod, posperiod :=
                    { first-1. A conservative external rate of return
                    { is obtained by considering negative payments as
                    { out from the investor, positive payments as in
                    { to the investor, and specifying:
                    { negperiod := first ;
                    { posperiod := last ;
                    { negrate := guaranteed safe rate of return ;
                    { posrate := expected average portfolio
                    { reinvestment rate of return. }

first,                { Initial payment period. }
last  : integer ;    { Final payment period. }
negperiod, posperiod : integer ;
                    { Periods to which negative or positive payments
                    { are to be discounted; if < first or > last then
                    { corresponding payments are not discounted. }
negrate, posrate : Extended ;
                    { Discount rates for negative and positive payments
                    { respectively; ignored if corresponding period
                    { does not satisfy first <= ...period <= last. }
var ncs : integer ;  { Error code = number of changes of sign
                    { among adjusted payments; on normal return
                    { ncs = 1.ncs = -2 if an inf or NaN
                    { payment was supplied. }
var ret : Extended ; { Rate of return: if ncs = 1 then ret will
                    { contain the single real root > -1; if ncs
                    { > 1 is odd, then ret will contain some
                    { real root > -1; if ncs > 1 is even ret
                    { may contain a real root > -1; otherwise
                    { ret will contain NaN. }

```



```

Procedure payment ( i : integer ; var pmt : Extended )
  { User-supplied procedure to provide pmt,
    the payment at period i. }
  { Fin_Npv guarantees first <= i <= last. }
);

```

Fin\_Npv is used to calculate the time value of a series of payments. Typically, a series of payments, to occur at times 1 through n, is to be discounted to a net present value at time 0 using a fixed discount rate r. The contribution of the first payment p1 will thus be  $p1/(1+r)$ ; the next will be  $p2/(1+r)^2$ ; the last  $pn/(1+r)^n$ . For this typical problem, first=1, last=n, net=0, and rate=r.

For a fixed series of payments,  $V_i$ , the net value at time i, and  $V_j$ , the net value at time j, are related by:

$$V_i = V_j * \text{compound}(\text{rate}, i-j).$$

So if the net value is zero at one time, it will be zero at any other time.

Note that discount rates  $\leq -1$  are meaningless from a financial point of view.

Often a transaction involving payments between two parties at different times is regarded as fair if the net discounted value of the payment series is zero at the agreed upon discount rate. Alternately, given a series of payments regarded as fair, we might interpret the effective interest rate as one making the net value of the payments zero. Note that roundoff error may prevent the net value from ever being exactly zero. Furthermore, the net value can not be zero if any payment is infinite or a NaN, or if all the nonzero payments have the same sign.

Fin\_Return is designed to solve the problem mentioned above: given a series of payments, what discount rate would result in a net value of zero? This is the conventional form of the Internal Rate of Return (IRR) problem. In this form, it should be obvious that there will not always be a rate corresponding to every series of payments: if any payment is infinite or NaN, or if all the payments have the same sign, then no discount rate can ever make the net value zero. It turns out in other cases that there may be no such rate or there may be several rates with equally valid right to be called "internal rate of return." Modified methods for solving such problems will be discussed later.

To obtain a conventional internal rate of return, in the Fin\_Return calling sequence set negperiod and posperiod to, for instance, first-1 or last+1. Then after the call, the output parameter ncs returns a code to aid in interpretation of the result ret.

Fin\_Return will not attempt to compute an internal rate of return if any payment is infinite or NaN or if all payments are zero or all nonzero

payments have the same sign. `Fin_Return` will return a NaN with code `NaNIRR` in these cases. `Ncs = -2` if any payment was infinite or NaN; `ncs = 0` in the other cases mentioned.

If `ncs >= 1` then its value is the number of changes of sign in the payment series. A change of sign occurs whenever a nonzero payment has different sign from the previous nonzero payment. Thus, in the sequence:

10, 8, 7, 0, 13, 0, -0, 1, 0, -1, 0, 0, -7, 0

there is exactly one change of sign, between +1 and -1. The zero payments are ignored in computing changes of sign.

The number of changes of sign is important: if it is an odd number then the internal rate of return problem has one or more solutions; if it is an even number `>= 2` then the internal rate of return problem may have one or more solution. Generally, the number of real solutions `> -1` is the number of changes of sign or is less than that number by an even integer. So a series with three changes of sign has three or one internal rates of return while a series with four changes of sign has four, two, or none.

`Fin_Return` always computes an internal rate of return if `ncs` is odd. If `ncs = 1` then assuredly `ret` contains the only internal rate of return. If `ncs >= 3` then `ret` contains an internal rate of return but there may be others and there is no assurance that the value in `ret` is appropriate in the user's context.

If `ncs >= 2` is even, `Fin_Return` will search for an internal rate of return but will soon give up if it can't find any. In the latter case `ret` will be `NaNIRR`. There is no way to distinguish the cases in which no internal rate of return exists from those in which `Fin_Return` is unable to find one. If `ret` is not a NaN then it is a valid rate of return but there is at least one other that may be equally valid.

When there are two or more changes of sign the interpretation of the internal rate of return is evidently not a simple matter. One may plot the net present value of a series as a function of discount rate. Points where the graph crosses the x-axis are internal rates of return. Perhaps one of these points will be obviously suitable.

Another approach to rate of return is to simplify the series of payments until there is only one change of sign. For instance, if there are only two payments of different sign,  $P_i$  at time  $i$  and  $P_j$  at time  $j$ , then the internal rate of return  $r$  is defined by the equation:

$$(1+r)^{j-i} = -P_j/P_i$$

which should be solved by the formula:

$$r := \exp( \ln( -(P_i+P_j)/P_i ) / (j-i) );$$

Various methods based on this approach are called adjusted, modified, financial management, or external rate of return. A subseries such as all the

positive payments is replaced by its discounted value at some time, using an externally defined discount rate. If that positive subseries is replaced by a single positive payment, either before or after all the negative payments, then there will be exactly one change of sign and exactly one internal rate of return. Either the positive subseries or the negative subseries or both may be discounted; the same external discount rate may be applied to both, or different ones may be applied to the negative and positive subseries.

As an example, consider the following series of payments:

-3, -2, 2, -1, 1                    IRR = -.325

It has three sign changes, so there are either one or three internal rates of return. We might discount all the negative payments to the beginning, using a discount rate of 0.5, to get a different series:

-43/9, 0, 2, 0, 1                    IRR = -.156

or we might discount all the positive payments to the end, using a discount rate of 0.75, to get:

-3, -2, 0, -1, 57/8                    IRR = +.055

or we might do both to get:

-43/9, 0, 0, 0, 57/8.                    IRR = +.100

Each of these three series has a unique internal rate of return, but these rates differ according to the choices made to simplify the problem.

Fin\_Return allows for all these possibilities. To discount the subseries of negative payments to a single time between first and last, simply specify negperiod to be that time and specify a discount rate in negrate. Similarly, posperiod and posrate may be used to discount the subseries of positive payments.

The following code fragments correspond to the previous examples:

```

var
  p : array[1..n] of real;

procedure payment(i: integer; var pmt: Extended);
begin
  SZX(p[i], pmt);
end;

begin
  SZX(0.5, negrate); SZX(0.75, posrate);

  Fin_Return(1, n, 0, n+1, negrate, posrate, ncs, retirr, payment);
  if ncs >= 1 then if not(ClassX(retirr,sgn) in [ QNAN,SNAN ] ) then
    { retirr is a conventional internal rate of return. } ...

```

```

Fin_Return(1, n, 1, n+1, negrate, posrate, ncs, retneg, payment);
if ncs >= 1 then { retneg is a return rate based on discounting
                 negative payments to the beginning. } ...

Fin_Return(1, n, 0, n, negrate, posrate, ncs, retpos, payment);
if ncs >= 1 then { retpos is a return rate based on discounting
                 positive payments to the end. } ...

Fin_Return(1, n, 1, n, negrate, posrate, ncs, retx, payment);
if ncs >= 1 then { retx is a return rate based on discounting all
                 payments to the beginning or end. } ...

end;

```

LisaCalc adopts the convention that negative payments are discounted to the first time period, and positive payments are discounted to the last time period. If only one discount rate is specified, it is used for both `negrate` and `posrate`.

A common type of complex investment involves several payments in followed by several payments out. Even though with only one sign change there is a unique internal rate of return, it may not be meaningful since it does not reflect external conditions. A frequent basis for analysis is to require that at the beginning, sufficient funds must be on hand to be able to guarantee all payments in. So all the payments in are discounted to the first period using a "safe" guaranteed rate of return such as the return on a conventional savings account. Payments out, on the other hand, are to be reinvested at another rate which is probably higher than the safe rate. This rate is sometimes called the "portfolio" or "reinvestment" rate and represents the average return of the investment portfolio. These externally defined safe and reinvestment rates modify the rate of return of the investment.

When analyzing complex investments, remember that the computed results are no better than the assumptions from which they were developed. In particular, measures of rate of return do not reflect the risk that some of the payments might not occur as expected.

#### D.4.9 Zero of a Nonlinear Function

```

Procedure Math_Solve (           { Computes zero of function. }
  est1, est2 : Extended ;       { A priori estimates of zero. }
  var res    : Extended ;       { f(res) may = 0 or NaN or its sign may
                                differ from one of its neighbors or it
                                may merely be the x with minimal
                                abs(f(x)) among those x sampled by
                                Math_Solve. The user must decide the
                                significance of the result res. }

```

```

procedure f ( x : Extended ; var fx : Extended )
  { User-supplied procedure to evaluate fx = f(x). }
  ;

```

Math\_Solve is used to find a zero  $z$  of a nonlinear function  $f(x)$ , that is, a place where  $f(z) = 0$ .  $Z$  is also called a root of the equation  $f(x) = 0$ .

The user must specify the function  $f$  which should be at least piecewise continuous; the better the function, the better Math\_Solve can perform. The user may also specify one or two starting guesses. The user may supply NaNs as guesses; then Math\_Solve will generate its own guesses which usually will not be as efficient as those the user might have supplied. Zero finding is tricky enough with good guesses, so the user should supply the best information he can.

Internally, Math\_Solve has two main phases: the search for a sign change interval and the refinement of such an interval. A sign change interval is an interval for which the values of  $f$  at the endpoints have different signs. If the function is continuous it will have a zero in the interval; if  $1/f(x)$  is continuous then  $f$  will have a pole in the interval. Thus finding a sign change interval is critical. That interval is sought using a secant method whenever that is productive, and a parabolic method otherwise. After the sign change interval is found, the secant method is used unless bisection is faster. If no sign change interval is found, Math\_Solve eventually gives up, leaving in  $res$  the point at which the sampled function's magnitude was minimal.

Only the user can determine the ultimate significance of  $res$ . That's because nonlinear functions display a variety of complicated behaviors that can't be handled equally efficiently by one subroutine. Many functions such as  $f(x) = 1 + x * x$  have no real zeros while others may hide their zeros where Math\_Solve can not find them.

To interpret  $res$ , compute  $f(res)$ . Seldom do we find the happy circumstance that  $f(res)$  is 0 without generating any exceptions. If inexact, underflow, or other exceptions were signalled then the user must decide whether to ignore them or to subject  $res$  to the further tests described below. If  $f(res)$  is a NaN then Math\_Solve has wandered outside the domain of validity of  $f$ . The user might want to extend the domain of  $f$  and try again. Sometimes such extension is trivial, as in the case of a removable discontinuity.

Suppose  $f(x)$  were defined as  $\sin(x)/x$ ; then at  $x = 0$  its value is a NaN, and if Math\_Solve were to look there it would stop with  $res = 0$ . Remove this discontinuity by defining  $f(x)$  by

```
if x = 0 then f(x) := 1 else f(x) := sin(x)/x;
```

A tougher case is a function like  $f(x) = \sqrt{x} - 2$ ; if Math\_Solve happens to look at  $x < 0$  it will stop on a NaN. In this case, extend this definition of  $f(x)$  leftward:

```
if x <= 0 then f(x) := -2 else f(x) := sqrt(x) - 2;
```

Many such domain problems can be avoided if the starting guesses are sufficiently close to the desired zero.

Suppose now that  $f(\text{res})$  is a nonzero number or infinite. One possibility is that  $\text{res}$  is actually a zero of  $f$  but that the computed value  $f(\text{res})$  is nonzero because of roundoff. Another possibility is that the true zero of  $f$  does not lie at a machine representable number but lies between  $\text{res}$  and one of its adjacent machine representable numbers. A third possibility is that  $\text{res}$  lies at or near a pole rather than a zero of  $f$ . Let's consider these cases in turn.

Often it is possible to compute an analytical error bound  $ef(x)$  for a function  $f(x)$  that indicates a bound on the roundoff error in the function at  $x$ . Then a reasonable approach is to evaluate  $f(\text{res})$  and  $ef(\text{res})$  and accept  $\text{res}$  as an approximate zero of  $f$  if the error bound dominates the function value, that is,  $\text{abs}(f(\text{res})) \leq \text{abs}(ef(\text{res}))$ .

Books on rounding error analysis provide examples for constructing analytical formulas for error bounds. Another possibility is to use interval arithmetic to obtain computational error bounds. The directed rounding modes of IEEE arithmetic are helpful in implementing interval arithmetic.

A simpler alternative that suffices in many cases is simply to evaluate  $f(\text{res})$  in each of the four IEEE rounding directions. If  $f$  is typical, then  $f(\text{res})$  will be different in each rounding direction. If all four values are nonzero with the same sign, it is usually safe to assume that the true value of  $f(\text{res})$  is not 0. If one of the four values is 0 or if the signs vary, then the true value of  $f(\text{res})$  may well be 0 and  $\text{res}$  may be taken to be an approximate zero of  $f$ . Furthermore, it often suffices to compute  $f(\text{res})$  only in upward and downward directions.

Turning now to the case that the true zero of  $f$  is not a machine representable number, we may evaluate  $f$  at both of  $\text{res}$ 's neighbors. If the sign of  $f$  at a neighbor differs from the sign of  $f(\text{res})$ , then  $f$  must have either a zero or a pole between  $\text{res}$  and its neighbor. On an interval in which  $f$  changes sign, it's not possible to distinguish zeros from poles. Other knowledge of the function, such as a bound on a derivative, may be helpful if this issue is in doubt.

If  $f$  is known to have a pole in the region of interest, it may be useful to remove the pole analytically before calling `Math_Solve`. For example, instead of solving  $f(x) = 3 - 1/x$ , solve  $f(x) = 3x - 1$  to avoid the pole at zero. But beware of introducing spurious zeros this way.

If none of the above produces an indication of a zero at or near  $\text{res}$ , then it may be that  $\text{res}$  is merely that point at which  $\text{abs}(f(x))$  was minimized among those  $x$  sampled by `Math_Solve`. Since many functions do not have real zeros, `Math_Solve` will eventually give up searching if for each point it tries,  $f$  has the same sign and there is no significant decrease in the magnitude of  $f$ . If `Math_Solve` ever finds two points for which  $f$  has different signs, then

it will persist in searching for a solution until it finds a point  $x$  where  $f(x)$  is 0 or NaN; failing that, the sign change interval will be reduced in size until the endpoints are adjacent machine representable numbers. But if the function value seems to vanish between two such numbers, then it makes sense to accept one of them as a reasonable approximation of the zero.

It must be emphasized that at best `Math_Solve` will find a zero of the function defined by the procedure `f`, which may not be the same function the user had in mind when he wrote that procedure. Because one function may have many mathematically equivalent expressions, it is the user's responsibility to find an expression that will not produce gratuitously wrong results in the presence of roundoff. Two examples of helpful principles: Avoid or minimize rounding error when possible (e.g.,  $x/10$  instead of  $0.1*x$ ), and cancel early rather than late (e.g.,  $(x+y)*(x-y)$  rather than  $x**2 - y**2$ ).

The following example is intended to find a zero of a polynomial function

$$p(x) = c_0 * x^n + c_1 * x^{n-1} + \dots + c_{n-1} * x + c_n$$

Note that the function is evaluated in extended precision using Horner's method of nested multiplications and additions, and the `Math_Solve` result `r` is evaluated according to the guidelines discussed above:

```

const n = { degree of polynomial } >= 0 ;

var c : array [ 0..n ] of real ;
. . .

procedure peval ( x : Extended ; var px : Extended ) ;

  var i : integer ;

begin { peval }
  SZX( c[0], px ) ;
  for i := 1 to n do begin { px := px * x + ci }
    MULX( x, px ) ;
    AddS( c[i], px ) ;
  end { px := px * x + ci } ;
end { peval } ;

. . .

Math_Solve( g1, g2, r, peval ) ;
ClearXcps ;
fr := peval(r) ;
if ClassX(fr,sgn) in [Qnan, Snan] then
  { extend function domain and try again }
else if (ClassX(fr,sgn) = ZERO) and { no exceptions } then
  { accept r as zero }

```

```

else begin
  SetRnd( DOWNWARD );
  fd := peval(r) ;
  SetRnd( UPWARD );
  fu := peval(r) ;
  SetRnd( TONEAREST );
  if SignOfX( fd ) <> SignOfX( fu ) then
    { accept r as zero }
  else begin
    left := NextX( r, neginf ); {neginf contains negative infinity}
    right := NextX( r, posinf ); {posinf contains positive infinity}
    fleft := peval(left) ;
    fright := peval(right) ;
    if (SignOfX( fleft ) <> SignOfX( fr ) )
      or (SignOfX( fright ) <> SignOfX( fr ) ) then
      { accept r as a zero }
    else { no zero was found }
  end ;
end ;

```

#### D.4.10 Linear Algebra

The linear algebra routines in MathLib solve common algebraic and statistical problems using methods that are independent of the storage formats of vectors and matrices. Prior to discussing specific routines we shall review relevant aspects of linear algebra.

##### D.4.10.1 Vectors and Linear Transformations

Linear algebra is concerned with elements in vector spaces and the class of linear transformations upon them. If that sounds too abstract, think about this specific example: The vector space is the set of points in a graphics window, forming a picture. One point, the origin, is special; often it is one of the corners. Typical linear transformations include the identity transformation, which does nothing, scaling transformations, which act like a zoom lens to magnify or reduce the picture, and rotations, which rotate the picture by a fixed angle relative to the origin. It is possible to combine linear transformations to create new ones.

The simplest way to understand the effect of a linear transformation in two dimensions is to consider what it does to the unit circle, which is a circle of radius one around the origin. The identity transformation leaves the circle unchanged; scaling transformations make the circle bigger or smaller; rotations leave the unit circle seemingly unchanged, although circles centered elsewhere are rotated as a whole. The unit sphere is the three-dimensional counterpart to the unit circle.

Most linear transformations can be inverted. For instance, a scaling transformation that magnifies by two can be inverted by the inverse



transformation: a scaling transformation that reduces by two. A 45-degree clockwise rotation can be inverted by a rotation of 45 degrees counter-clockwise.

Transformations that have inverses are called nonsingular; transformations without inverses are called singular. To understand singularity, consider the cases of ordinary multiplication and division of numbers. The transformation "multiply by  $x$ ", as in  $z := x * y$ , is nonsingular unless  $x = 0$ . The inverse transformation "divide by  $x$ ", as in  $y := z / x$ , does not exist when  $x = 0$ . We could define a "pseudo-inverse" transformation:

```
if x = 0 then y := 0 else y := z/x ;
```

which exists for any  $x$ , but we would not expect to recover the original value of  $y$  unless by luck it were 0.

Two-dimensional linear transformations can only map the unit circle in certain ways. Nonsingular transformations map the unit circle into a circle or an ellipse. Singular transformations map the unit circle into a line segment or point. There are no other possibilities. A singular linear transformation that maps the unit circle to a line segment is not one-to-one; it maps more than one point in the unit circle to the same point on the line segment. Such a transformation has no inverse because a point on the line segment may have come from more than one point on the unit circle, and there's no way to tell from which it came. However, pseudo-inverses have been defined which make somewhat arbitrary choices; all linear transformations have pseudo-inverses.

#### D.4.10.2 Transformations Between Spaces of Different Dimension

Transformations may be defined which map elements of one vector space into elements of another. For instance, a painting of a three-dimensional scene is based on artistic perspective convention for mapping three dimensions into two.

Linear transformations that map vectors from two dimensions to three can at best map the unit circle into a two-dimensional object in the three-dimensional space. Transformations from three dimensions to two map the unit sphere into at most a two-dimensional object, of course. Generally speaking, a transformation that maps the unit circle or sphere into an object of the maximum possible dimensionality is said to be of full rank. Otherwise it is said to be rank-deficient. When the two spaces are of the same dimension, then "full rank" is the same as "nonsingular" and "rank-deficient" is the same as "singular."

#### D.4.10.3 Arrays and Matrices

Programming languages deal with arrays of numbers rather than elements of a vector space and transformations upon them. Arrays of numbers can have any meaning that the programmer wishes to assign, but conventionally vectors are represented by an array with one dimension. Thus an element of a two-dimensional vector space might be declared as

**u : array [1..2] of real ;**

where  $u[1]$  is the first coordinate, along the x axis, and  $u[2]$  is the second coordinate, along the y axis, of a point in a two-dimensional space. The size of a vector is measured by its Euclidean length, which is the square root of the sum of the squares of its elements:

**lengthu := sqrt( sqr(u[1]) + sqr(u[2]) ) ;**

Linear transformations mapping n-dimensional spaces to m-dimensional spaces are conveniently declared as

**a : array [1..m, 1..n] of real ;**

The following discussion uses the term "matrix" to refer to an array representing a single linear transformation. The individual components of a matrix A depend on the linear transformation that A represents.

In general, the components of an array representing a two-dimensional linear transformation can be determined by examining the effect of the transformation on the unit vectors E1 and E2 corresponding to the coordinates (1,0) and (0,1). The first column of A contains the coordinates of the result of applying the transformation to E1 and the second column contains the coordinates corresponding to E2.

In two dimensions, to represent the identity transformation:

```
for i := 1 to 2 do for j := 1 to 2 do
  if i=j then a[i,j] := 1 else a[i,j] := 0 ;
```

while to represent a three times magnification:

```
for i := 1 to 2 do for j := 1 to 2 do
  if i=j then a[i,j] := 3 else a[i,j] := 0 ;
```

and to represent a rotation through angle t:

```
a[1,1] := cos(t) ; a[1,2] := +sin(t) ;
a[2,1] := -sin(t) ; a[2,2] := cos(t) ;
```

One singular transformation is the zero transformation which maps everything to the origin:

```
for i := 1 to 2 do for j := 1 to 2 do
  a[i,j] := 0 ;
```

Another singular transformation maps any vector vertically onto the x-axis:

```
for i := 1 to 2 do for j := 1 to 2 do
  a[i,j] := 0 ;
a[1,1] := 1 ;
```

It maps the unit circle into a line segment on the x-axis.

Sometimes it is convenient to think of a two-dimensional array [1..m, 1..n], not as a transformation from an n-dimensional vector space to an

m-dimensional vector space, but as a collection of  $n$  distinct vectors of dimension  $m$ . For instance, a triangle is defined by specifying its three vertices, so an array of three columns may be used to represent a triangle.

With the conventions for vectors and transformations outlined above, there are operations for applying transformations to one or more vectors, composing transformations, finding the vector that would be transformed to a given one, and computing inverse and pseudo-inverse transformations.

### Composing Transformations

To represent a transformation  $C$  which first performs  $A$ , then performs  $B$ , multiply the matrix  $B$  times the matrix  $A$ ; in mathematical notation,  $C := B * A$ . In Pascal you could write

```
var
  a, b, c : array [1..n, 1..n] of real ;

  for i := 1 to n do for j := 1 to n do begin
    t := 0 ;
    for k := 1 to n do t := t + b[i,k]*a[k,j] ;
    c[i,j] := t ;
  end ;
```

although the matrix multiplication routine in MathLib is better. If you ever wondered why the textbook definition of matrix multiplication is so complicated, it is to insure that transformations can be combined by multiplying their matrices in this way. Matrix multiplication only works when the second dimension of  $B$  is the same as the first dimension of  $A$ , because it only makes sense to compose two such transformations when the result space of  $A$  is the same as the operand space of  $B$ .

To apply a transformation represented by an array  $A$  to a vector  $X$ , simply multiply them together to get the transformed vector  $B$ :

```
B := A * X
```

Note that  $X$  might represent one or more vectors depending on the number of columns of  $X$ .

### Linear Equations

The assignment  $B:=A*X$  computes  $B$ , given  $A$  and  $X$ . The inverse problem, to compute  $X$ , given  $A$  and  $B$ , is usually called "solving a system of linear equations." The dimensions of  $B$ ,  $A$ , and  $X$  must conform so that  $A$  and  $X$  could be multiplied to get  $B$ . If  $A$  is square and nonsingular, there will always be a unique  $X$  satisfying  $B=A*X$ .

MathLib procedures find  $X$  directly from  $B$  and  $A$ . Another way to find  $X$  is to find  $P$ , the inverse transformation of  $A$ , and apply it to  $B$ :

```
X := P * B
```

But computing  $P$  explicitly is always slower and less accurate than computing  $X$  directly from  $B$  and  $A$ .

### Linear Least Squares

The equation  $B=A*X$  sometimes has solutions  $X$  even when  $A$  is singular or not square. Sometimes there is more than one such  $X$ , at other times there is none. All these cases can be generalized as the "linear least squares" problem: Given  $B$  and  $A$ , find an  $X$  that minimizes the length of the residual  $R:=B-A*X$ . Such an  $X$  always exists;  $X$  will be unique if and only if  $Y=0$  is the unique solution of the equation  $0=A*Y$ .

Clearly  $X$  solves the linear equation problem  $B=A*X$  if and only if  $R:=B-A*X$  is zero. Therefore, MathLib provides just one set of procedures to solve the linear least squares problem; these procedures can also be used to solve linear equations. A solution  $X$  is always computed directly from  $B$  and  $A$ ; if there is more than one solution  $X$ , MathLib returns an  $X$  whose length is small, but not necessarily minimal among all  $X$  minimizing the length of  $R$ .

Only square nonsingular matrices  $A$  have inverses, but every matrix  $A$  has a pseudo-inverse  $P$ , which may be applied to  $B$  to compute  $X$ :

$$X := P * B$$

But computing  $P$  explicitly is always slower and less accurate than computing  $X$  directly from  $B$  and  $A$ .

An even more inaccurate method for obtaining  $X$  is to solve the linear equation system:

$$(A^T*B) = (A^T*A) * X$$

using  $A^T$ , the transpose of  $A$ .

Avoid methods that require  $P$  or  $A^T*A$  rather than  $A$ ; they are inaccurate, or slow, or both.

### Existence

MathLib always computes an  $x$  to solve a linear least squares problem. How can you tell whether that  $x$  is also a solution of the system of linear equations  $B=A*X$ ?

That depends on the shape of  $A$ . If  $A$  has at least as many columns as rows, *and*  $A$  is of full rank, then  $x$  would satisfy, in the absence of rounding errors,  $B=A*X$ . Fullness of rank is indicated by a condition number greater than zero, discussed in Section D.4.10.4.

If  $A$  has more rows than columns or is rank deficient, then it will be necessary to actually compute the residual  $R:=B-A*X$  to see if it is zero or negligible compared to  $B$ .

### Uniqueness

MathLib always computes some  $X$ , even when the linear equation system  $B=A*X$  has zero, one, or many solutions. The multiplicity of solutions may

be seen even for  $b=a*x$  where  $b$ ,  $a$ , and  $x$  are real numbers. This equation has a unique solution  $x=b/a$  if  $a \neq 0$ . But if  $a=0$ , then  $b$  determines the number of solutions. When  $a=0$  and  $b=0$ , any value of  $x$  is a solution; when  $a=0$  and  $b \neq 0$ , no value of  $x$  is a solution.

But the related problem "minimize  $|b - ax|$ " always has at least one solution  $x$ . When  $a=0$ , then MathLib chooses the solution  $x=0$ , regardless of  $b$ . This is because among all the solutions  $x$ , namely all the real numbers,  $x=0$  has the smallest magnitude.

When MathLib has computed a solution  $x$  that minimizes  $R=B-A*X$ , how can you tell that it is unique? That depends on the shape of  $A$ . If  $A$  has more columns than rows, then  $X$  is never unique. If the number of  $A$ 's rows is greater than or equal to the number of  $A$ 's columns, then  $X$  will be unique if and only if  $A$  is of full rank. Fullness of rank is indicated by a condition number greater than zero.

#### D.4.10.4 III-Conditioned Problems

All the operations we have discussed are subject to roundoff errors during each floating-point operation. This has important implications because roundoff errors blur the distinction between matrices of full and deficient rank. A matrix may be of full rank, but if it is close enough to a rank-deficient matrix, the result  $X$  may not be satisfactory: it may be far from the correct solution  $X$ , and the residual  $R := B - A * X$  might not be minimal. The condition number  $COND$  supplies an estimate of the effect of roundoff:  $COND$  will be zero for singular and rank-deficient matrices  $A$  and greater than zero for nonsingular and full rank  $A$ . The largest possible value of  $COND$  is 1, which is attained by the identity and rotation matrices, among others. Generally, you can not count on more than  $18 + \text{LOG}_{10}(COND)$  significant digits being correct in the largest component of  $X$ , with fewer reliable digits in smaller components. But occasionally  $X$  will by chance be more accurate than  $COND$  suggests.

$COND$  is actually an estimate of the relative change in  $A$  to make  $A$  into the nearest rank-deficient matrix. Matrices with small  $COND$  often cause trouble because they are close to rank-deficient. The corresponding transformations map the unit circle into very skinny ellipses, which from a distance look much like the line segments generated by rank-deficient transformations. Two points on opposite sides of such a skinny ellipse may be very close together, perhaps within a rounding error, but the corresponding points on the unit circle that they were mapped from may be much further apart. So small errors like rounding errors can cause big errors when computing solutions  $X$  to linear equations or least squares problems.

#### D.4.10.5 Determinants

MathLib provides routines to obtain the determinant of a square matrix. The determinant is not defined if the matrix is not square.

The determinant of a square matrix has valid uses in statistical computations, but the determinant is most often used inappropriately as a  $x$

criterion for singularity. The determinant of a singular square matrix is zero and the determinant of a nonsingular square matrix is not zero, but a nonzero determinant tells nothing about the condition of the problem. Consider a two-by-two matrix  $A$  with  $u$  and  $v$  on the diagonal,  $|u| \leq |v|$ , and zeros off the diagonal. The determinant is  $u*v$ , and the condition number is  $|u/v|$ . The distance to the nearest singular matrix is  $|u|$ ; this distance relative to  $A$  is  $|u/v|$ , the condition number. Both the determinant and condition number are zero if  $A$  is singular, an infrequent occurrence; only the condition number is helpful in the far more common case when  $A$  may be nearly, but not quite, singular. Since the determinant can only be used to distinguish singular from nonsingular, and rounding errors blur this distinction, the use of the determinant is not recommended. Use COND instead.

#### D.4.10.6 Iterative Improvement

Iterative improvement is a technique for refining a first approximation to a solution of a linear equations or linear least squares problem. Given an approximate solution  $X_0$ , iterative improvement computes a residual  $R := B - A * X_0$  and then solves the equation  $R = A * DX$  using a factorization of  $A$ . Then the improved solution is  $X_1 := X_0 + DX$ . Usually one iteration improves the residual and moves  $X_1$  closer to the correct answer. Subsequent iterations are sometimes helpful but they may worsen  $R$ ,  $X_n$ , or both.

The LinSys operators in LisaCalc and Lisa BASIC always perform one iteration of iterative improvement.

#### D.4.10.7 Statistical Computations with $A^T A$

Many important statistical problems of regression are formulated in terms of the matrix  $A^T A$ , which is the matrix product of  $A^T$ , the transpose of  $A$ , with  $A$  itself. For instance the solution of the linear least squares problem "choose  $X$  to minimize the length of  $B - A * X$ " is the same as the solution of the linear equation

$$A^T A * X = A^T * B$$

in exact arithmetic. But since the solution must be computed in the presence of rounding errors and  $A$  may be rank-deficient or nearly so, least squares problems are better solved without forming  $A^T A$ .

MathLib does provide two procedures for solving problems formulated in terms of  $A^T A$ . Neither computes  $A^T A$  or its factorization; instead the solutions are more accurately determined from the factorization of  $A$  itself. Standard errors can be determined from the diagonal elements of the inverse of  $A^T A$ ; these can be obtained by solving

$$A^T A * X = \text{Identity}$$

Determinants of  $A^T A$  are of interest when  $A^T A$  is a correlation matrix.

## D.4.10.8 Linear Algebra Procedures

```

Procedure Mat_Mult (      { Matrix multiplication B := A * X. }
  n,                    { Rows of A = rows of B. }
  p,                    { Columns of A = rows of X. }
  m : integer ;        { Columns of X = columns of B. }
  overlap : boolean ;  { True if B overlaps A or X; temporary
                        B is created on heap and copied at
                        end. }
  var error : boolean ; { True if failure due to lack of heap
                        space. Not possible if overlap
                        false. }

  procedure afetch ( i,j : integer ; var aij : Extended ) ;
    { User routine to provide aij := A[i,j]. }
    { Afetch may assume 1 <= i <= n, 1 <= j <= p. }
  procedure xfetch ( i,j : integer ; var xij : Extended ) ;
    { User routine to provide xij := X[i,j]. }
    { Xfetch may assume 1 <= i <= p, 1 <= j <= m. }
  procedure bstore ( i,j : integer ;   bij : Extended )
    { User routine to store B[i,j] := bij. }
    { Bstore may assume 1 <= i <= n, 1 <= j <= m. }
) ;

Procedure QR_Factor (    { Compute the QR factorization of
                          matrix A. }
  n,                    { Number of rows of A. }
  p : integer ;        { Number of columns of A. }
  pivot : boolean ;    { True if pivoting is to be performed,
                          false if not. }
  var QR : P_QR_Record ; { Pointer to factorization of A, which
                          will be created in the heap in an
                          internal format. QR will be ord(NIL)
                          if insufficient heap space is
                          available. }

  procedure afetch ( i,j : integer ; var aij : Extended ) ;
    { User routine to provide aij := A[i,j]. }
    { Afetch may assume 1 <= i <= n, 1 <= j <= p. }
) ;

Procedure QR_Condition ( { Estimate condition number of
                          matrix whose factorization is in
                          QR^*. }
  QR : P_QR_Record ;    { QR^* is a decomposed matrix
                          produced by QR_Factor. }
  var cond : Extended   { Estimate of condition number. }
) ;

```

```

Procedure QR_Determinant (      { Compute determinant of
                                matrix whose factorization is in
                                QR^ . }

    QR : P_QR_Record ;        { QR^ is a decomposed matrix
                                produced by QR_Factor. }
    var det : Extended        { Determinant. }
) ;

Procedure QR_Solve (          { Compute X = pseudo-inverse(QR^) * B
                                to solve linear equations or linear
                                least squares problems. }

    m : integer ;            { Number of columns of X and B. }
    QR : P_QR_Record ;      { QR^ is a decomposed matrix
                                produced by QR_Factor. }
    var error : boolean ;    { True if procedure failed
                                due to lack of heap space. }
    procedure bfetch ( i,j : integer ; var bij : Extended )
        { User routine to provide bij := B[i,j]. }
        { Bfetch may assume 1 <= i <= n, 1 <= j <= m. }
    procedure xstore ( i,j : integer ;   xij : Extended ) ;
        { User routine to store X[i,j] := xij. }
        { Xstore may assume 1 <= i <= p, 1 <= j <= m. }
) ;

Procedure QR_Residual (      { Compute residual R := B - AX for a
                                linear equations or linear
                                least-squares problem }

    n,                        { Number of rows of A. }
    p : integer ;            { Number of columns of A. }
    m : integer ;            { Number of columns of X and B. }
    procedure afetch ( i,j : integer ; var aij : Extended ) ;
        { User routine to provide aij := A[i,j]. }
        { Afetch may assume 1 <= i <= n, 1 <= j <= p. }
    procedure bfetch ( i,j : integer ; var bij : Extended )
        { User routine to provide bij := B[i,j]. }
        { Bfetch may assume 1 <= i <= n, 1 <= j <= m. }
    procedure xfetch ( i,j : integer ; var xij : Extended ) ;
        { User routine to provide xij := X[i,j]. }
        { Xfetch may assume 1 <= i <= p, 1 <= j <= m. }
    procedure rstore ( i,j : integer ;   rij : Extended )
        { User routine to store R[i,j] := rij. }
        { Rstore may assume 1 <= i <= n, 1 <= j <= m. }
) ;

```



```

Procedure QR_Improve (      { Perform one iteration to improve
                             the solution X of a linear equations
                             or linear least squares problem
                             A * X = B. }
  m : integer ;           { Number of columns of X and B. }
  QR : P_QR_Record ;     { QR^ is a decomposed matrix
                             produced by QR_Factor. }
  var error : boolean ;  { True if QR_Improve failed
                             due to lack of heap space. }
  procedure afetch ( i, j : integer ; var aij : Extended ) ;
    { User routine to provide aij := A[i, j]. }
    { Afetch may assume 1 <= i <= n, 1 <= j <= p. }
  procedure bfetch ( i, j : integer ; var bij : Extended )
    { User routine to provide bij := B[i, j]. }
    { Bfetch may assume 1 <= i <= n, 1 <= j <= m. }
  procedure xfetch ( i, j : integer ; var xij : Extended ) ;
    { User routine to provide xij := X[i, j]. }
    { Xfetch may assume 1 <= i <= p, 1 <= j <= m. }
  procedure xstore ( i, j : integer ;      xij : Extended )
    { User routine to store X[i, j] := xij. }
    { Xstore may assume 1 <= i <= p, 1 <= j <= m. }
) ;

Procedure QR_TranSolve (   { Compute a solution for (ATA) X = B,
                             where T denotes transpose, given
                             factorization of A in QR^ . }
  m : integer ;           { Number of columns of X and B. }
  QR : P_QR_Record ;     { QR^ is a decomposed matrix
                             produced by QR_Factor. }
  var error : boolean ;  { True if procedure failed
                             due to lack of heap space. }
  procedure bfetch ( i, j : integer ; var bij : Extended )
    { User routine to provide bij := B[i, j]. }
    { Bfetch may assume 1 <= i <= p, 1 <= j <= m. }
  procedure xstore ( i, j : integer ;      xij : Extended )
    { User routine to store X[i, j] := xij. }
    { Xstore may assume 1 <= i <= p, 1 <= j <= m. }
) ;

Procedure QR_TranDeterminant ( { Compute determinant of ATA
                                 given factorization of A in QR^ . }
  QR : P_QR_Record ;         { QR^ is a decomposed matrix
                                 produced by QR_Factor. }
  var det : Extended        { Determinant. }
) ;

```

Mat\_Mult performs matrix multiplication in order to determine the effect of a linear transformation upon one or more vectors or upon another linear transformation. The user specifies the dimensions of arrays A, X, and B, and defines procedures that provide access to the elements of these arrays. Mat\_Mult is not concerned with the internal organization of the arrays, which may be more general or of a different structure than the array type defined in the Pascal language. Mat\_Mult calls the user-defined -fetch and -store procedures (afetch, xfetch, etc.) to fetch or store the (i,j) element of the user's arrays.

The result B may overlap the inputs A or X. If so, Mat\_Mult must compute a temporary copy of B prior to storing any of it lest an input be overwritten prematurely. The boolean overlap is specified by the user accordingly. If the user has specified that the data overlap, then Mat\_Mult creates its temporary copy of B on the Pascal heap. If the heap is nearly full then there may not be sufficient room to hold B. Then Mat\_Mult will terminate and set the boolean error true prior to performing any computation. If the user sets overlap true prior to the call then he must check error after the call. Any heap space used by Mat\_Mult is released prior to returning.

The following example illustrates a typical use of Mat\_Mult and demonstrates overlapping X and B as well as how to create and access a matrix A which is larger than 32768 bytes, the limit for a Pascal data structure.

```

const n = 1000 ;
      p = 100 ;
      m = 2 ;

var a : longint ;
    aifactor : longint ; { aifactor * i <= 400000 requires 32 bit
                          integers }
    ajfactor : integer ; { ajfactor * j <= 400    requires 16
                          bit integers }

    b : array [ 1..n, 1..m ] of real ;
    error : boolean ;

procedure fetcha( i, j : integer ; var aij : Extended ) ;
var pr : ^ real ;
begin
  pr := pointer( a + aifactor * i + ajfactor * j ) ;
  SZX( pr^, aij ) ;
end ;

```

```

procedure fetchx( i, j : integer ; var xij : Extended ) ;
begin
  SZX( b[i,j], xij ) ;
end ;

procedure storeb( i, j : integer ;    bij : Extended ) ;
begin
  X2S( bij, b[i,j] ) ;
end ;

{ Create space for a on heap. }
a := FP_New( ord4( n ) * ord4( p ) * SizeOf( real ) ) ;

if a = ord4(nil) then
  { no room for a! }
else begin
  aifactor := SizeOf(real) * ord4( p ) ;
  ajfactor := SizeOf(real) ;
  a := a - aifactor - ajfactor ;

  { a will point to a[0,0] to improve the efficiency of afetch. }

  { Now fill a with its elements, and b with the elements of x. }

  Mat_Mult( n, p, m, true, error, fetcha, fetchx, storeb ) ;

  if error then { not enough room on heap } else { OK }
end ;

```

#### D.4.10.9 QR Factorization

The MathLib routines to solve systems of linear equations  $A * X = B$  and linear least squares problems depend on first obtaining the QR factorization of the matrix  $A$ . Every  $n$ -by- $p$  matrix  $A$  can be factored into a product of two matrices  $Q$  and  $R$ .

The  $n$ -by- $n$  orthogonal matrix  $Q$  represents an  $n$ -dimensional rotation of the coordinate axes and so preserves lengths of vectors. The inverse of  $Q$  is just its transpose  $Q^T$ .

The  $n$ -by- $p$  triangular matrix  $R$  has zeros below the diagonal: if  $i > j$  then  $R[i,j] = 0$ . This form makes  $R * X = Q^T * B$  easier to solve for  $X$  than  $A * X = B$ . In MathLib, `QR_Factor` performs the factorization  $A = Q * R$ , and `QR_Solve` computes  $X$ .

It turns out that smaller residuals  $B - A * X$  can often be obtained if a process called column pivoting is performed during the QR factorization. This

amounts to performing the factorization first on the column of largest norm, then on the column of largest norm among those remaining, and so on. The effect is to produce three factors  $Q * R * P = A$ , where  $P$  is a  $p$ -by- $p$  permutation matrix: an identity matrix with some of the rows interchanged. Column pivoting is optional in `QR_Factor` since some matrices can be analyzed in advance to show that they do not require it. But if column pivoting has not been shown to be unnecessary then it should be performed. Pivoting usually improves accuracy but it may slow down the factorization by a factor of five to ten per cent for square matrices. LisaCalc and Lisa BASIC always perform column pivoting.

`QR_Factor` stores the factorization  $QRP$  in a condensed internal form on the Pascal heap. `QR_Factor` returns a pointer to the factorization for use by the other QR routines. None of these other routines releases the heap space allocated by `QR_Factor`, so it is up to the user to mark the heap before calling `QR_Factor` and to release the heap to the same mark when that factorization is no longer required. The other QR routines that allocate space on the Pascal heap release that space before returning. All the QR routines that require heap space contain an error flag in their calling sequences and terminate without storing any result if sufficient heap space is not available.

#### D.4.10.10 MathLib QR Procedures

`QR_Factor` is the factorization routine. Its inputs describe  $A$ ; its output is a pointer to the factorization  $QRP$ . That pointer and factorization are only useful to the other QR routines in MathLib. About  $18 + 10np$  bytes are allocated on the heap if pivoting is not requested; pivoting requires an additional  $20p$  bytes. Execution time is proportional to  $n^3$  for an  $n$ -by- $n$  matrix.

`QR_Determinant` computes the determinant of  $A$  very quickly given  $A$ 's QR factorization. A NaN is returned if the matrix  $A$  is not square.

`QR_Condition` provides an estimate of the condition number of  $A$  with respect to solving linear equations or least squares problems. Conventionally this condition number is defined to be the ratio of the largest singular value of  $A$  to the smallest, and thus ranges from 1 upward to infinity.

`QR_Condition` inverts this ratio and so returns a number ranging from 1 down to 0. Furthermore, since computation of singular values is fairly time consuming, `QR_Condition` only makes an estimate of the largest and smallest singular values, which sometimes may vary substantially from the correct values. Execution time is about twenty percent of the time required for the factorization. `QR_Condition` requires  $10p$  bytes of heap space.

`QR_Solve` finds the  $X$  in  $A * X = B$  given  $A$ 's factorization. It requires  $10 * \max(n,p)$  bytes of heap space. The  $j$ 'th column of  $X$  may overwrite the  $j$ 'th column of  $B$ .

QR\_Residual provides a convenient computation of the residual  $R := B - A * X$ , not to be confused with the R in the QR factorization!

QR\_Improve uses QR\_Residual and QR\_Solve to perform one iteration of improvement of the solution X.

QR\_TranSolve computes a solution X of  $A^T A * X = B$  from the QR factorization of A.

QR\_TranDeterminant computes the determinant of  $A^T A$  from the QR factorization of A; even if A has no determinant,  $A^T A$  is always square and always has a determinant.

#### D.4.10.11 QR Example

The following example codes a procedure LinSys that works somewhat like the LinSys in LisaCalc and Lisa BASIC, but its arguments are limited to Pascal real arrays.

LinSys solves m linear least squares problems:

"For  $k=1$  to m, find  $x_{i,k}$  to minimize the length of

$$r_{1,k} = (a_{1,1}x_{1,k} + a_{1,2}x_{2,k} + \dots + a_{1,p}x_{p,k}) - b_{1,k}$$

...

$$r_{n,k} = (a_{n,1}x_{1,k} + a_{n,2}x_{2,k} + \dots + a_{n,p}x_{p,k}) - b_{n,k} "$$

If  $r_{j,k} = 0$  then  $x_{i,k}$  also solves the m systems of linear equations

$$a_{1,1}x_{1,k} + a_{1,2}x_{2,k} + \dots + a_{1,p}x_{p,k} = b_{1,k}$$

...

$$a_{n,1}x_{1,k} + a_{n,2}x_{2,k} + \dots + a_{n,p}x_{p,k} = b_{n,k}$$

```
type atype = array [1..n, 1..p] of real ;
    btype = array [1..n, 1..m] of real ;
    xtype = array [1..p, 1..m] of real ;
```

```
var amatrix : atype ;
    bmatrix : btype ;
    xmatrix : xtype ;
```

```
det, cond : real ;
    { Last determinant and condition number computed by linsys. }
```

```
function linsys ( a: atype; b: btype; var x: xtype ) : boolean ;
```

```
{ Linsys will find x to minimize b-a*x, if possible; will return a
  function value of FALSE if successful, TRUE otherwise; will
```

```

    update det and cond with the determinant and condition estimate
    for a. }

var marker : ^ integer ;
    qr : P_QR_Record ;
    error : boolean ;

procedure fetcha( i, j : integer ; var aij : extended ) ;
begin
    SZX( a[i,j], aij ) ;
end ;

procedure fetchb( i, j : integer ; var bij : extended ) ;
begin
    SZX( b[i,j], bij ) ;
end ;

procedure storex( i, j : integer ; xij : extended ) ;
begin
    XZS( xij, b[i,j] ) ;
end ;

procedure fetchx( i, j : integer ; var xij : extended ) ;
begin
    SZX( b[i,j], xij ) ;
end ;

begin { linsys }
    mark(marker) ; { Mark heap storage for subsequent release. }

    QR_Factor( n, p, {pivot} true, qr, fetcha ) ;
    if qr = ord4(nil) then error := true
    else begin { factorization OK }
        QR_Determinant ( qr, det ) ;
        QR_Condition ( qr, cond ) ; { Cond error represented by NaN.}
        QR_Solve( m, qr, error, fetchb, storex ) ;
        if not error then begin { solve OK }
            QR_Improve ( m, qr, error, fetcha, fetchb, fetchx, storex);
            { Only one improvement iteration. }
        end { solve OK } ;

    end { factorization OK } ;

    linsys := error ;
    release(marker) ; { Release heap storage. }
end { linsys } ;

```

**D.4.11 MathLib NaNs**

Besides the NaNs that can be generated by the procedures in FPLib, there are some NaN codes that are used by the procedures in MathLib to signify unusual results:

<u>Name</u>	<u>Dec</u>	<u>Hex</u>	<u>Meaning</u>
NaNIRR	39	\$27	Internal rate of return is not real, does not exist, or was not found.
NaNDet	49	\$31	nonsquare matrix has no determinant.
NaNCond	50	\$32	Condition estimate could not be computed because of inadequate heap space.

**D.4.12 MathLib Interface**

```

UNIT MathLib ; INTRINSIC ;

INTERFACE

{ Lisa Math Library. }

{$C Copyright 1983, 1984, Apple Computer Inc. }

USES FPLib ;

    CONST

{ Lisa Math Library constants. }

RandModulus = 2147483647 ;
                { Prime modulus for random number generation = 2^31-1. }

LSigDigLen = 30 ;    { Length of significand string. }

    TYPE

{ Lisa Math Library types. }

RoundPrecision = ( ExtPrecision, DblPrecision, RealPrecision) ;

Type FP_Type = ( TFP_byte, TFP_integer, TFP_longint, TFP_Comp, TFP_real,
                TFP_Double, TFP_Extended ) ;
                { Number type names for FP_size.}

Free_Format = record
    MaxSig : integer ;
    Sig_FForm,
    Trail_Point,
    Int_EForm,
    Plus_EForm : boolean ;
end ;
                { Specifications for free-form output. }
                { Maximum number of significant digits. }
                { True if "fixed" style applies MaxSig to }
                { significant digits; false if to digits after }
                { the point. }
                { True if trailing point should be printed for }
                { inexact values in "integral" style. }
                { True if "exponential" style acceptable for }
                { integral values. }
                { True if "exponential" style should exhibit }
                { + sign for positive exponents. }

P_QR_Record = longint ;    { Pointer to matrix factored as QRP. }

```



```
LongSigDig = string[LSigDigLen] ;
```

```
LongDecimal = record
    sgn : 0..1 ;
    exp : integer ;
    sig : LongSigDig ;
end ;
```

```
{-----}
```

```
{ Elementary functions to support BASIC and Fortran. }
```

```
procedure ASinX ( var x : Extended ) ; { x := asin(x) }
procedure ACosX ( var x : Extended ) ; { x := acos(x) }

procedure SinhX ( var x : Extended ) ; { x := sinh(x) }
procedure CoshX ( var x : Extended ) ; { x := cosh(x) }
procedure TanhX ( var x : Extended ) ; { x := tanh(x) }
```

```
{-----}
```

```
{ Procedures to support polar coordinates. }
```

```
procedure Abs2X ( x, y : Extended ; var z : Extended ) ; { z := abs(y+ix) }
procedure ATan2X( x, y : Extended ; var z : Extended ) ; { z := arg(y+ix) }
```

```
{-----}
```

```
{ Random number procedure. }
```

```
function NextRandom ( lastrandom : longint ) : longint ;
    { Returns next "random" longint with 1 <= nextrandom <= RandModulus-1. }
```

```
{-----}
```

```
{ Floating point status and mode procedures. }
```

```
procedure ClearXcps ; { Turns off all exception flags. }
procedure ClearHlts ; { Turns off all halt flags. }
procedure SetPrecision ( p : RoundPrecision ) ;
    { Set extended rounding precision. }
function GetPrecision : RoundPrecision ;
    { Get extended rounding precision. }
```

```
{-----}
```

```

    { Sort procedure. }

procedure Math_Sort ( { General procedure to stably sort an arbitrary list. }
    first, last : integer ; { Records first..last will be sorted. }
    function Sorted ( i, j : integer ) : boolean ;
        { User-supplied procedure called by Math_Sort to compare order of
          records i and j. Math_sort guarantees first <= i < j <= last.
          Sorted returns true if records i and j are already correctly
          sorted with respect to each other. }
    procedure Swap ( i, j : integer ) ;
        { User-supplied procedure called by Math_Sort to swap records i
          and j. Math_sort guarantees first <= i < j <= last. }
    var error : boolean ) ; { True if sort routine failed due to
                            insufficient heap space available. }

-----

    { Miscellaneous utility procedures. }

function SignOfX ( x : Extended ) : boolean ;      { True if x has neg sign. }

function FP_New ( n : longint ) : longint ;
    { Attempts to allocate n bytes on heap, returning address.
      Returns ord4(nil) if space not available. }

procedure FP_Size ( x : Extended ; var sgn : integer ; var class : NumClass ; var
    size : FP_Type ) ;
    { Returns sign bit, class, and size of smallest type that
      would hold x exactly. }

procedure FP_Free_ASCII ( { Procedure to provide free-form ASCII output. }
    x : Extended ; { Number to be converted from binary to ASCII. }
    width : integer ; { Maximum number of characters in output string. }
    form : Free_Format ; { Detailed format specifications. }
    var s : Decstr ) ; { Output destination string. If, after call,
                       length(s) > width, then x was inconsistent with
                       the constraints Width or MaxSig. }

-----

    { Financial analysis procedures. }

procedure Fin_Npv      (      { Compute net value of series of payments. }
    first,              { First payment period. }
    last,               { Last payment period. }
    net : integer ;    { Period at which net value is to be computed;
                       need not be between first and last. }

```

```

rate      : Extended ; { Periodic interest rate. }
var Npv   : Extended ; { Net payment value. }
Procedure payment ( i : integer ; var pmt : Extended )
    { User-supplied procedure to provide pmt, the payment at
      period i. }
    { Fin_Npv guarantees first <= i <= last. }
);

```

```

procedure Fin_Return ( { Analyze series of payments for external or internal
rate of return. Discounting by external rates may be
specified for positive or negative payments or both or
neither. Standard internal rate of return is obtained
by specifying, for example, negperiod, posperiod :=
first-1. A conservative external rate of return is
obtained by considering negative payments as out from
the investor, positive payments as in to the investor,
and specifying:
    negperiod := first ;
    posperiod := last ;
    negrate := guaranteed safe rate of return ;
    posrate := expected average portfolio reinvestment
              rate of return. }

```

```

first,          { Initial payment period. }
last   : integer ; { Final payment period. }
negperiod, posperiod : integer ;
    { Periods to which negative or positive payments
      are to be discounted; if < first or > last then
      corresponding payments are not discounted. }
negrate, posrate : Extended ;
    { Discount rates for negative and positive payments
      respectively; ignored if corresponding period
      does not satisfy first <= ...period <= last. }
var ncs : integer ; { Error code = number of changes of sign among
adjusted payments; on normal return ncs =
1.ncs = -2 if an inf or NaN payment was
supplied. }
var ret : Extended ; { Rate of return: if ncs = 1 then ret will
contain the single real root > -1; if ncs >
1 then ret will contain some real root > -1 if
ncs is odd; if ncs > 1 is even ret may contain
a real root > -1; otherwise ret will contain
NaN. }
Procedure payment ( i : integer ; var pmt : Extended )
    { User-supplied procedure to provide pmt,
      the payment at period i. }

```

```

        { Fin_Npv guarantees first <= i <= last. }
    );
}
{ Numerical algebra. }

procedure Mat_Mult (
    n,
    p,
    m : integer ;
    overlap : boolean ;
    var error : boolean ;
    procedure afetch ( i, j : integer ; var aij : Extended ) ;
    procedure xfetch ( i, j : integer ; var xij : Extended ) ;
    procedure bstore ( i, j : integer ;      bij : Extended ) ;
) ;
    { Matrix multiplication B := A * X. }
    { Rows of A = rows of B. }
    { Columns of A = rows of X. }
    { Columns of X = columns of B. }
    { True if B overlaps A or X; temporary B is
      created on heap and copied at end. }
    { True if failure due to lack of heap space.
      Not possible if overlap false. }
    { User routine to provide aij := A[i, j].
      Afetch may assume 1 <= i <= n, 1 <= j <= p. }
    { User routine to provide xij := X[i, j].
      Xfetch may assume 1 <= i <= p, 1 <= j <= m. }
    { User routine to store B[i, j] := bij.
      Bstore may assume 1 <= i <= n, 1 <= j <= m. }

procedure QR_Factor (
    n,
    p : integer ;
    pivot : boolean ;
    var QR : P_QR_Record ;
    procedure afetch ( i, j : integer ; var aij : Extended ) ;
) ;
    { Compute the QR factorization of matrix A. }
    { Number of rows of A. }
    { Number of columns of A. }
    { True if pivoting is to be performed, false if
      not. }
    { Pointer to factorization of A, which will be
      created in the heap in an internal format.
      QR will be ord(NIL) if insufficient heap
      space is available. }
    { User routine to provide aij := A[i, j].
      Afetch may assume 1 <= i <= n, 1 <= j <= p. }

procedure QR_Condition (
    QR : P_QR_Record ;
    var cond : Extended
) ;
    { Estimate condition number of
      matrix whose factorization is in QR^*. }
    { QR^* is a decomposed matrix produced by
      QR_Factor. }
    { Estimate of condition number. }

```

```

procedure QR_Determinant (      { Compute determinant of matrix whose
                                factorization is in QR^ . }
  QR : P_QR_Record ;          { QR^ is a decomposed matrix produced by
                                QR_Factor. }
  var det : Extended         { Determinant. }
) ;

procedure QR_Solve (           { Compute X = pseudo-inverse(QR^ ) * B to Solve
                                linear equations or linear least squares
                                problems. }
  m : integer ;               { Number of columns of X and B. }
  QR : P_QR_Record ;         { QR^ is a decomposed matrix produced by
                                QR_Factor. }
  var error : boolean ;      { True if procedure failed due to lack of heap
                                space. }
  procedure bfetch ( i, j : integer ; var bij : Extended )
  { User routine to provide bij := B[i, j]. }
  { Bfetch may assume 1 <= i <= n, 1 <= j <= m. }
  procedure xstore ( i, j : integer ; xij : Extended ) ;
  { User routine to store X[i, j] := xij. }
  { Xstore may assume 1 <= i <= p, 1 <= j <= m. }
) ;

procedure QR_Residual (       { Compute residual R := B - AX for a linear
                                equations or linear least squares problem. }
  n,                          { Number of rows of A. }
  p : integer ;               { Number of columns of A. }
  m : integer ;               { Number of columns of X and B. }
  procedure afetch ( i, j : integer ; var aij : Extended ) ;
  { User routine to provide aij := A[i, j]. }
  { Afetch may assume 1 <= i <= n, 1 <= j <= p. }
  procedure bfetch ( i, j : integer ; var bij : Extended )
  { User routine to provide bij := B[i, j]. }
  { Bfetch may assume 1 <= i <= n, 1 <= j <= m. }
  procedure xfetch ( i, j : integer ; var xij : Extended ) ;
  { User routine to provide xij := X[i, j]. }
  { Xfetch may assume 1 <= i <= p, 1 <= j <= m. }
  procedure rstore ( i, j : integer ; rij : Extended )
  { User routine to store R[i, j] := rij. }
  { Rstore may assume 1 <= i <= n, 1 <= j <= m. }
) ;

procedure QR_Improve (        { Perform one iteration to improve the
                                solution X of a linear equations or linear
                                least squares problem A * X = B. }
  m : integer ;               { Number of columns of X and B. }

```

```

QR : P_QR_Record ;      { QR^ is a decomposed matrix produced by
                        { QR_Factor. }
var error : boolean ;  { True if procedure failed due to lack of heap
                        { space. }
procedure afetch ( i,j : integer ; var aij : Extended ) ;
                        { User routine to provide aij := A[i,j]. }
                        { Afetch may assume 1 <= i <= n, 1 <= j <= p. }
procedure bfetch ( i,j : integer ; var bij : Extended )
                        { User routine to provide bij := B[i,j]. }
                        { Bfetch may assume 1 <= i <= n, 1 <= j <= m. }
procedure xfetch ( i,j : integer ; var xij : Extended ) ;
                        { User routine to provide xij := X[i,j]. }
                        { Xfetch may assume 1 <= i <= p, 1 <= j <= m. }
procedure xstore ( i,j : integer ;      xij : Extended )
                        { User routine to store X[i,j] := xij. }
                        { Xstore may assume 1 <= i <= p, 1 <= j <= m. }
) ;

procedure QR_TranSolve (      { Compute a solution for (ATA) X = B, where T
                              { denotes transpose, given factorization of A
                              { in QR^ . }
m : integer ;                { Number of columns of X and B. }
QR : P_QR_Record ;          { QR^ is a decomposed matrix produced by
                              { QR_Factor. }
var error : boolean ;      { True if procedure failed due to lack of heap
                              { space. }
procedure bfetch ( i,j : integer ; var bij : Extended )
                              { User routine to provide bij := B[i,j]. }
                              { Bfetch may assume 1 <= i <= p, 1 <= j <= m. }
procedure xstore ( i,j : integer ;      xij : Extended )
                              { User routine to store X[i,j] := xij. }
                              { Xstore may assume 1 <= i <= p, 1 <= j <= m. }
) ;

procedure QR_TranDeterminant ( { Compute determinant of ATA given
                               { factorization of A in QR^ . }
QR : P_QR_Record ;          { QR^ is a decomposed matrix produced by
                               { QR_Factor. }
var det : Extended          { Determinant. }
) ;

-----
{ Procedures for correctly rounded conversion between binary and
  decimal. }

```

```
procedure X2LDec ( f : DecForm ; x : Extended ; var y : LongDecimal ) ;
    { Converts x to y, correctly rounded according to f. }

procedure LDec2X ( prec: RoundPrecision; x: LongDecimal; var y: Extended ) ;
    { Converts x to y, correctly rounded according to prec. }

-----

    { Numerical analysis. }

procedure Math_Solve (           { Computes zero of function. }
    est1, est2 : Extended ;      { A priori estimates of zero. }
    var res    : Extended ;      { f(res) may = 0 or NaN or its sign may differ
                                from one of its neighbors or it may merely
                                be the x with minimal abs(f(x)) among those x
                                sampled by Math_Solve. The user must decide
                                the significance of the result res. }
    procedure f ( x : Extended ; var fx : Extended )
                                { User-supplied procedure to evaluate fx = f(x). }
    ) ;

-----
```

**D.5 Macintosh Floating-Point Programming**

Sections D.2, D.3, and D.4 describe floating-point programming for the Lisa. Floating-point programming for the Macintosh is similar; the changes are described below.

Assembly-language programs that use FP68K may be assembled on the Lisa and run on the Macintosh or on MacWorks. Pascal programs that use *real* arithmetic or the intrinsic units FPLib or MathLib may be compiled with the Lisa Pascal Compiler and run on Macintosh or Macworks.

**WARNING**

---

Early Macintosh developers received the files:

```
INTRFC/SANE.TEXT  OBJ/SANE.OBJ  OBJ/SANEAsm.OBJ
INTRFC/Elms.TEXT  OBJ/Elms.OBJ  OBJ/ElmsAsm.OBJ
```

which are no longer recommended, and older versions of the files:

```
OBJ/MacPasLib.OBJ  TLASM/ToolMacs.TEXT  TLASM/SANEMacs.TEXT
```

which have been replaced by newer versions distributed with the Macintosh software supplement. Do not mix any of these older files with the newer ones described below.

---

**D.5.1 Assembly Language**

Include the files TLASM/SANEMacs, TLASM/ToolEqu, and TLASM/ToolMacs with your assembly-language source files. It is not necessary to link with any other Lisa files to get assembly-language floating-point arithmetic. In the file TLASM/SANEMacs, the first equate, FPByTrap, must be 1 to run on Macintosh or MacWorks, or 0 to run on the Lisa Operating System.

**D.5.2 Pascal Real Arithmetic**

It is not necessary to USE any Pascal files to compile Pascal *real* arithmetic. Link with the files:

```
OBJ/RealPasUnit  OBJ/FPUnit  OBJ/FPSub  OBJ/MacPasLib
```

**D.5.3 FPLib and MathLib**

Regular versions of the units FPLib and MathLib, called FPUnit and MathUnit, are available in the files OBJ/FPUnit and OBJ/MathUnit. Change your USES statement accordingly:

```
USES {$U OBJ/FPUnit}  FPUnit,
      {$U OBJ/MathUnit} MathUnit ;
```

Do not include {\$U INTRFC/SANE} SANE or {\$U INTRFC/Elms} Elms in your USES statement.



Link with the files:

OBJ/MathUnit    OBJ/FPUnit    OBJ/RealPasUnit  
OBJ/FPSub      OBJ/MacPasLib

Only the procedures you actually need will be linked into your object file.  
Do not link with:

OBJ/SANE    OBJ/SANEAsm    OBJ/Elms    OBJ/ElmsAsm

#### **D.5.4 Restrictions**

Assembly-language programmers should clear the floating-point environment with `FSetEnv` prior to any floating-point operations. Pascal programmers should call

**Procedure `InitFPLib` ;**

which is declared in the `FPUnit` interface, prior to any floating-point operations.

`MathLib` depends on certain `IOSPasLib` procedures that are not implemented in `OBJ/MacPasLib`. Consequently, certain `MathUnit` procedures do not work reliably. Affected procedures include financial rate of return, matrix, and sorting.

# Appendix E

## QuickDraw

E.1	About This Appendix .....	E-1
E.2	About QuickDraw .....	E-2
E.2.1	How To Use QuickDraw .....	E-3
E.2.2	QuickDraw Data Types .....	E-4
E.3	The Mathematical Foundation of QuickDraw .....	E-4
E.3.1	The Coordinate Plane .....	E-4
E.3.2	Points .....	E-5
E.3.3	Rectangles .....	E-6
E.3.4	Regions .....	E-7
E.4	Graphic Entities .....	E-9
E.4.1	The Bit Image .....	E-9
E.4.2	The Bitmap .....	E-11
E.4.3	Patterns .....	E-13
E.4.4	Cursors .....	E-13
E.5	The Drawing Environment: GrafPort .....	E-15
E.5.1	Pen Characteristics .....	E-18
E.5.2	Text Characteristics .....	E-20
E.6	Coordinates in GrafPorts .....	E-22
E.7	General Discussion of Drawing .....	E-24
E.7.1	Transfer Modes .....	E-26
E.7.2	Drawing in Color .....	E-28
E.8	Pictures and Polygons .....	E-28
E.8.1	Pictures .....	E-29
E.8.2	Polygons .....	E-30
E.9	QuickDraw Routines .....	E-31
E.9.1	GrafPort Routines .....	E-32
E.9.2	Cursor-Handling Routines .....	E-36
E.9.3	Pen and Line-Drawing Routines .....	E-37
E.9.4	Text-Drawing Routines .....	E-40
E.9.5	Drawing in Color .....	E-43

E.9.6	Calculations with Rectangles .....	E-43
E.9.7	Graphic Operations on Rectangles .....	E-46
E.9.8	Graphic Operations on Ovals .....	E-47
E.9.9	Graphic Operations on Rounded-Corner Rectangles .....	E-47
E.9.10	Graphic Operations on Arcs and Wedges .....	E-49
E.9.11	Calculations with Regions .....	E-51
E.9.12	Graphic Operations on Regions .....	E-55
E.9.13	Bit Transfer Operations .....	E-56
E.9.14	Pictures .....	E-58
E.9.15	Calculations with Polygons .....	E-59
E.9.16	Graphic Operations on Polygons .....	E-61
E.9.17	Calculations with Points .....	E-62
E.9.18	Miscellaneous Utilities .....	E-64
<b>E.10</b>	<b>Customizing QuickDraw Operations .....</b>	<b>E-67</b>
<b>E.11</b>	<b>Using QuickDraw from Assembly Language .....</b>	<b>E-71</b>
E.11.1	Constants .....	E-71
E.11.2	Data Types .....	E-71
E.11.3	Global Variables .....	E-73
E.11.4	Procedures and Functions .....	E-73
<b>E.12</b>	<b>Graf3D: Three-Dimensional Graphics .....</b>	<b>E-75</b>
E.12.1	How Graf3D is Related to QuickDraw .....	E-75
E.12.2	Features of Graf3D .....	E-75
E.12.3	Graf3D Data Types .....	E-76
E.12.4	Graf3D Procedures and Functions .....	E-77
<b>E.13</b>	<b>QuickDraw Interface .....</b>	<b>E-80</b>
E.13.1	Graf3D Interface .....	E-89
<b>E.14</b>	<b>QuickDraw Sample Programs .....</b>	<b>E-91</b>
E.14.1	QDSample .....	E-91
E.14.2	Boxes .....	E-101
<b>E.15</b>	<b>QDSupport .....</b>	<b>E-106</b>
<b>E.16</b>	<b>Glossary .....</b>	<b>E-108</b>

# QuickDraw

## E.1 About This Appendix

This appendix describes QuickDraw, a set of graphics procedures, functions, and data types that allows a Pascal or assembly-language programmer of Lisa to perform highly complex graphic operations very easily and very quickly. It covers the graphic concepts behind QuickDraw, as well as the technical details of the data types, procedures, and functions you will use in your programs.

We assume that you are familiar with the Lisa Workshop Manager, Lisa Pascal, and the Lisa Operating System's memory management. This graphics package is for programmers, not end users. Although QuickDraw may be used from either Pascal or assembly language, all examples are given in their Pascal form, to be clear, concise, and more intuitive; Section E.11 describes the details of the assembly-language interface to QuickDraw.

The appendix begins with an introduction to QuickDraw and what you can do with it (Section E.2). It then steps back a little and looks at the mathematical concepts that form the foundation for QuickDraw: coordinate planes, points, and rectangles (Section E.3). Once you understand these concepts, read on to Section E.4, which describes the graphic entities based on them--how the mathematical world of planes and rectangles is translated into the physical phenomena of light and shadow.

Then comes some discussion of how to use several graphics ports (Section E.6), a summary of the basic drawing process (Section E.7), and a discussion of two more parts of QuickDraw, pictures and polygons (Section E.8).

Next, in Section E.9, there's a detailed description of all QuickDraw procedures and functions, their parameters, calling protocol, effects, side effects, and so on--all the technical information you'll need each time you write a program for the Lisa.

Following these descriptions are sections that will not be of interest to all readers. Special information is given in Section E.10 for programmers who want to customize QuickDraw operations by overriding the standard drawing procedures, in Section E.11 for those who will be using QuickDraw from assembly language, and in Section E.12 for those interested in creating three-dimensional graphics using the Graf3D unit.

Finally, there are listings of the QuickDraw Interface (Section E.13), two sample programs (Section E.14), and the QDSupport unit (E.15); and a glossary that explains terms that may be unfamiliar to you (Section E.16).

**E.2 About QuickDraw**

QuickDraw allows you to organize the Lisa screen into a number of individual areas. Within each area you can draw many things, as illustrated in Figure E-1.

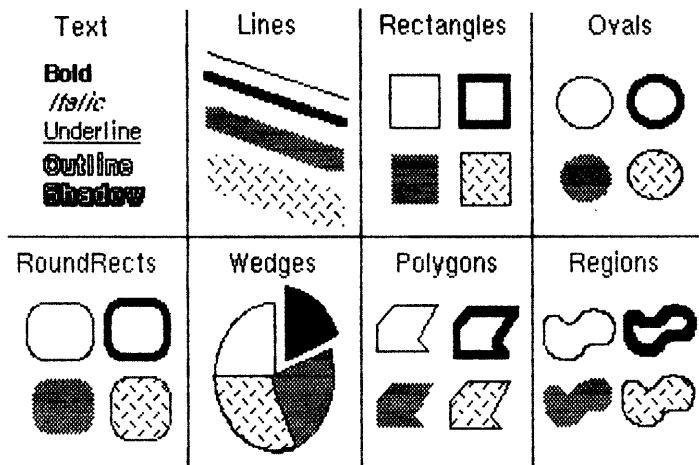

**Figure E-1**  
**Samples of QuickDraw's Abilities**

You can draw:

- Text characters in a number of proportionally-spaced fonts, with variations that include boldfacing, italicizing, underlining, and outlining.
- Straight lines of any length and width.
- A variety of shapes, either solid or hollow, including: rectangles, with or without rounded corners; full circles and ovals or wedge-shaped sections; and polygons.
- Any other arbitrary shape or collection of shapes, again either solid or hollow.
- A picture consisting of any combination of the above items, with just a single procedure call.

In addition, QuickDraw has some other abilities that you won't find in many other graphics packages. These abilities take care of most of the "house-

keeping"--the trivial but time-consuming and bothersome overhead that's necessary to keep things in order.

- The ability to define many distinct *ports* on the screen, each with its own complete drawing environment--its own coordinate system, drawing location, character set, location on the screen, and so on. You can easily switch from one such port to another.
- Full and complete *clipping* to arbitrary areas, so that drawing will occur only where you want. It's like a super-duper coloring book that won't let you color outside the lines. You don't have to worry about accidentally drawing over something else on the screen, or drawing off the screen and destroying memory.
- Off-screen drawing. Anything you can draw on the screen, you can draw into an off-screen buffer, so you can prepare an image for an output device without disturbing the screen, or you can prepare a picture and move it onto the screen very quickly.

And QuickDraw lives up to its name! It's very fast. The speed and responsiveness of the Lisa user interface are due primarily to the speed of the QuickDraw package. You can do good-quality animation, fast interactive graphics, and complex yet speedy text displays using the full features of QuickDraw. This means you don't have to bypass the general-purpose QuickDraw routines by writing a lot of special routines to improve speed.

#### E.2.1 How To Use QuickDraw

QuickDraw can be used from either Pascal or MC68000 machine language. It has no user interface of its own.

If you're using Pascal, you must write a Pascal program that includes the proper QuickDraw calls, compile it against the files `QD/QuickDraw.OBJ` and `QD/QDSupport.OBJ`, link it with the files listed in `QD/QDstuff.TEXT`, and execute the linked object file.

If you're using machine language, your program should include the proper QuickDraw calls, and `.INCLUDE` the file `QD/GRAFTYPES.TEXT`. Assemble the program, link it with the files listed in `QD/QDstuff.TEXT`, and execute the linked object file.

A programming model, `QDSample`, is included with the Workshop software in the file `QD/QDSample.TEXT` (listed in Section E.14.1); it shows the structure of a properly organized QuickDraw program. What's best for beginners is to read through the text, and, using the superstructure of the program as a "shell", modify it to suit your own purposes. Once you get the hang of writing programs inside the presupplied shell, you can work on changing the shell itself.

Note that all files related to QuickDraw are prefixed by "QD/".

QuickDraw includes only the graphics and utility procedures and functions you'll need to create graphics on the screen. Procedures for dealing with the

mouse, cursors, keyboard, and screen settings, as well as those allowing you to generate sounds and read and set clocks and dates, are described in Appendix F, Hardware Interface.

### E.2.2 QuickDraw Data Types

QuickDraw defines three general data types, `QDByte`, `QDPtr`, and `QDHandle`:

```
type QDByte = -128..127
      QDPtr  = ^QDByte
      QDHandle = ^QDPtr
```

Other data types are described throughout this appendix in the sections in which they're relevant. For a summary of all QuickDraw data types, see Section E.13.2.

### E.3 The Mathematical Foundation of QuickDraw

To create graphics that are both precise and pretty requires not super-charged features but a firm mathematical foundation for the features you have. If the mathematics that underlie a graphics package are imprecise or fuzzy, the graphics will be, too. QuickDraw defines some clear mathematical constructs that are widely used in its procedures, functions, and data types: the *coordinate plane*, the *point*, the *rectangle*, and the *region*.

#### E.3.1 The Coordinate Plane

All information about location, placement, or movement that you give to QuickDraw is in terms of coordinates on a plane. The coordinate plane is a two-dimensional grid, as illustrated in Figure E-2.

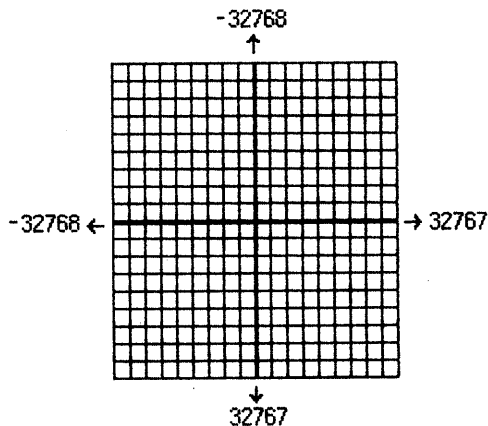

Figure E-2  
The Coordinate Plane

There are two distinctive features of the QuickDraw coordinate plane:

- All grid coordinates are integers.
- All grid lines are infinitely thin.

These concepts are important! First, they mean that the QuickDraw plane is finite, not infinite (although it's very large). Horizontal coordinates range from -32768 to +32767, and vertical coordinates have the same range.

Second, they mean that all elements represented on the coordinate plane are mathematically pure. Mathematical calculations using integer arithmetic will produce intuitively correct results. If you keep in mind that grid lines are infinitely thin, you'll never have "endpoint paranoia"--the confusion that results from not knowing whether that last dot is included in the line.

### E.3.2 Points

On the coordinate plane are 4,294,967,296 unique points. Each point is at the intersection of a horizontal grid line and a vertical grid line. As the grid lines are infinitely thin, a point is infinitely small. Of course there are more points on this grid than there are dots on the Lisa screen: when using QuickDraw you associate small parts of the grid with areas on the screen, so that you aren't bound into an arbitrary, limited coordinate system.

The coordinate origin (0,0) is in the middle of the grid. Horizontal coordinates increase as you move from left to right, and vertical coordinates increase as you move from top to bottom. This is the way both a TV screen and a page of English text are scanned: from the top left to the bottom right.

You can store the coordinates of a point in a Pascal variable whose type is defined by QuickDraw. The type `Point` is a record of two integers, and has the following structure:

```

type VHSlect = (V,H);
Point      = record case integer of

    0: (v: integer;
        h: integer);

    1: (vh: array [VHSlect] of integer)

end;
```

The variant part allows you to access the vertical and horizontal components of a point either individually or as an array. For example, if the variable `goodPt` were declared to be of type `Point`, the following would all refer to the coordinate parts of the point:

```

goodPt.v          goodPt.h
goodPt.vh[V]     goodPt.vh[H]
```



### E.3.3 Rectangles

Any two points can define the top left and bottom right corners of a rectangle. As these points are infinitely small, the borders of the rectangle are infinitely thin (see Figure E-3).

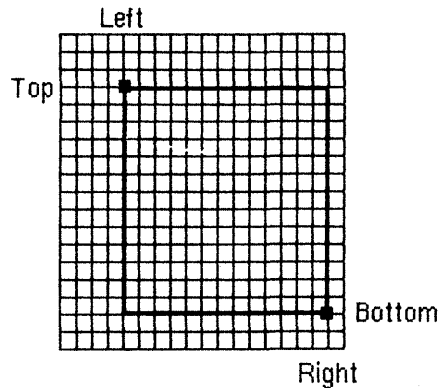

**Figure E-3**  
**A Rectangle**

Rectangles are used to define active areas on the screen, to assign coordinate systems to graphic entities, and to specify the locations and sizes for various drawing commands. QuickDraw also allows you to perform many mathematical calculations on rectangles--changing their sizes, shifting them around, and so on.

---

#### NOTE

Remember that rectangles, like points, are mathematical concepts that have no direct representation on the screen. The association between these conceptual elements and their physical representations is made by a bitmap, described below.

---

The data type for rectangles is `Rect`, and consists of four integers or two points:

```

type Rect = record case integer of
    0: (top:    integer;
        left:   integer;
        bottom: integer;
        right:  integer);
    1: (topLeft: Point;
        botRight: Point)
end;

```

Again, the record variant allows you to access a variable of type `Rect` either as four boundary coordinates or as two diagonally opposing corner points. Combined with the record variant for points, all of the following references to the rectangle named `bRect` are legal:

<code>bRect</code>		{type <code>Rect</code> }
<code>bRect.topLeft</code>	<code>bRect.botRight</code>	{type <code>Point</code> }
<code>bRect.top</code>	<code>bRect.left</code>	{type <code>integer</code> }
<code>bRect.topLeft.v</code>	<code>bRect.topLeft.h</code>	{type <code>integer</code> }
<code>bRect.topLeft.vh[V]</code>	<code>bRect.topLeft.vh[H]</code>	{type <code>integer</code> }
<code>bRect.bottom</code>	<code>bRect.right</code>	{type <code>integer</code> }
<code>bRect.botRight.v</code>	<code>bRect.botRight.h</code>	{type <code>integer</code> }
<code>bRect.botRight.vh[V]</code>	<code>bRect.botRight.vh[H]</code>	{type <code>integer</code> }

---

#### WARNING

---

If the bottom coordinate of a rectangle is equal to or less than the top, or the right coordinate is equal to or less than the left, the rectangle is an *empty* rectangle (i.e., one that contains no bits).

---

### E.3.4 Regions

Unlike most graphics packages that can manipulate only simple geometric structures (usually rectilinear, at that), QuickDraw can gather an arbitrary set of spatially coherent points into a structure called a region, and perform complex yet rapid manipulations and calculations on such structures. This remarkable feature not only will make your standard programs simpler and faster, but will let you perform operations that would otherwise be nearly impossible; it is fundamental to the Lisa user interface.

You define a region by drawing lines, shapes such as rectangles and ovals, or even other regions. The outline of a region should be one or more closed loops. A region can be concave or convex, can consist of one area or many disjoint areas, and can even have "holes" in the middle. In Figure E-4, the region on the left has a hole in the middle, and the region on the right consists of two disjoint areas.

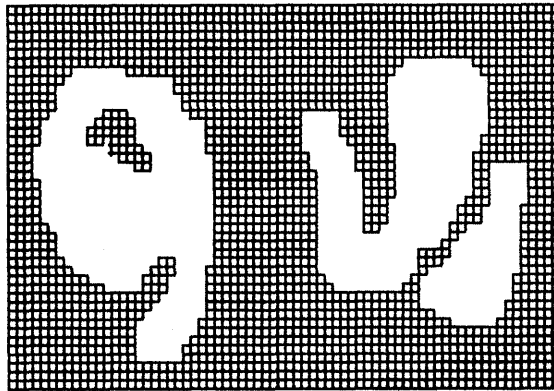

Figure E-4  
Regions

Because a region can be any arbitrary area or set of areas on the coordinate plane, it takes a variable amount of information to store the outline of a region. The data structure for a region, therefore, is a variable-length entity with two fixed fields at the beginning, followed by a variable-length data field:

```
type Region = record
    rgnSize: integer;
    rgnBBox: Rect;
    {optional region definition data}
end;
```

The `rgnSize` field contains the size, in bytes, of the region variable. The `rgnBBox` field is a rectangle which completely encloses the region.

The simplest region is a rectangle. In this case, the `rgnBBox` field defines the entire region, and there is no optional region data. For rectangular regions (or empty regions), the `rgnSize` field contains 10 (two bytes for `rgnSize`, plus eight for `rgnBBox`).

The region definition data for nonrectangular regions is stored in a compact way which allows for highly efficient access by QuickDraw procedures.

As regions are of variable size, they are stored dynamically on the heap, and the Operating System's memory management moves them around as their sizes change. Being dynamic, a region can be accessed only through a pointer; but when a region is moved, all pointers referring to it must be updated. For this reason, all regions are accessed through *handles*, which point to one master pointer which in turn points to the region.

```
type RgnPtr    = ^Region;
     RgnHandle = ^RgnPtr;
```

When the memory management relocates a region's data in memory, it updates only the `RgnPtr` master pointer to that region. The references through the master pointer can find the region's new home, but any references pointing directly to the region's previous position in memory would now point at dead bits. To access individual fields of a region, use the region handle and double indirection:

```
myRgn^.rgnSize      {size of region whose handle is myRgn}
myRgn^.rgnBBox      {rectangle enclosing the same region}
myRgn^.rgnBBox.top  {minimum vertical coordinate of all points
                    in the region}
myRgn^.rgnBBox      {semantically incorrect; will not compile if
                    myRgn is a RgnHandle}
```

Regions are created by a QuickDraw function which allocates space for the region, creates a master pointer, and returns a region handle. When you're done with a region, you dispose of it with another QuickDraw routine which frees up the space used by the region. Only these calls allocate or deallocate regions; do *not* use the Pascal procedure `new` to create a new region!

You specify the outline of a region with procedures that draw lines and shapes, as described in Section E.9, QuickDraw Routines. An example is given in the discussion of `CloseRgn` in Section E.9.11, Calculations with Regions.

Many calculations can be performed on regions. A region can be "expanded" or "shrunk" and, given any two regions, QuickDraw can find their union, intersection, difference, and exclusive-OR; it can also determine whether a given point or rectangle intersects a given region, and so on. There is of course a set of graphic operations on regions to draw them on the screen.

## E.4 Graphic Entities

Coordinate planes, points, rectangles, and regions are all good mathematical models, but they aren't really graphic elements--they don't have a direct physical appearance. Some graphic entities that do have a direct graphic interpretation are the *bit image*, *bitmap*, *pattern*, and *cursor*. This section describes the data structure of these graphic entities and how they relate to the mathematical constructs described above.

### E.4.1 The Bit Image

A bit image is a collection of bits in memory which have a rectilinear representation. Take a collection of words in memory and lay them end to

end so that bit 15 of the lowest-numbered word is on the left and bit 0 of the highest-numbered word is on the far right. Then take this array of bits and divide it, on word boundaries, into a number of equal-size rows. Stack these rows vertically so that the first row is on the top and the last row is on the bottom. The result is a matrix like the one shown in Figure E-5--rows and columns of bits, with each row containing the same number of bytes. The number of bytes in each row of the bit image is called the *row width* of that image.

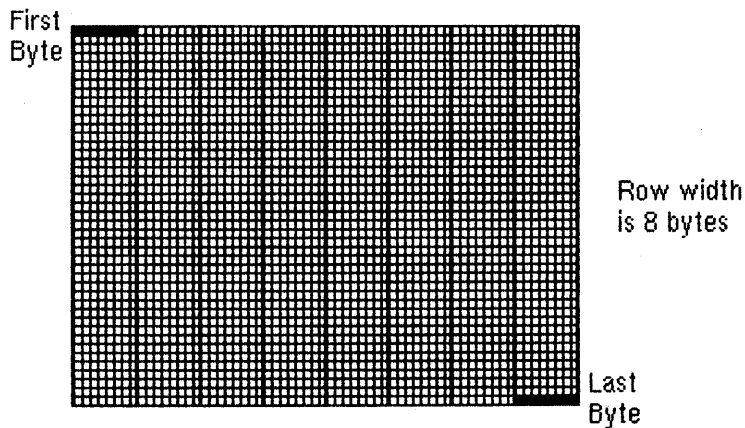

Figure E-5  
A Bit Image

A bit image can be stored in any static or dynamic variable, and can be of any length that is a multiple of the row width.

The Lisa screen itself is one large visible bit image. There are 32,760 bytes of memory that are displayed as a matrix of 262,080 *pixels* on the screen, each bit corresponding to one pixel. If a bit's value is 0, its pixel is white; if the bit's value is 1, the pixel is black.

The screen is 364 pixels tall and 720 pixels wide, and the row width of its bit image is 90 bytes. Each pixel on the screen is one and a half times taller than it is wide, meaning a rectangle 30 pixels wide by 20 tall looks square, and a 30 by 20 oval looks circular. There are 90 pixels per inch horizontally, and 60 per inch vertically.

## NOTE

---

Since each pixel on the screen represents one bit in a bit image, wherever this appendix says "bit", you can substitute "pixel" if the bit image is the Lisa screen. Likewise, this appendix often refers to pixels on the screen where the discussion applies equally to bits in an off-screen bit image.

---

## E.4.2 The Bitmap

When you combine the physical entity of a bit image with the conceptual entities of the coordinate plane and rectangle, you get a bitmap. A bitmap has three parts: a pointer to a bit image, the row width (in bytes) of that image, and a boundary rectangle which gives the bitmap both its dimensions and a coordinate system. Notice that a bitmap does not actually include the bits themselves: it points to them.

There can be several bitmaps pointing to the same bit image, each imposing a different coordinate system on it. This important feature is explained more fully in Section E.6, Coordinates in GrafPorts.

As shown in Figure E-6, the data structure of a bitmap is as follows:

```

type Bitmap = record
    baseAddr: QDPtr;
    rowBytes: integer;
    bounds: Rect
end;

```

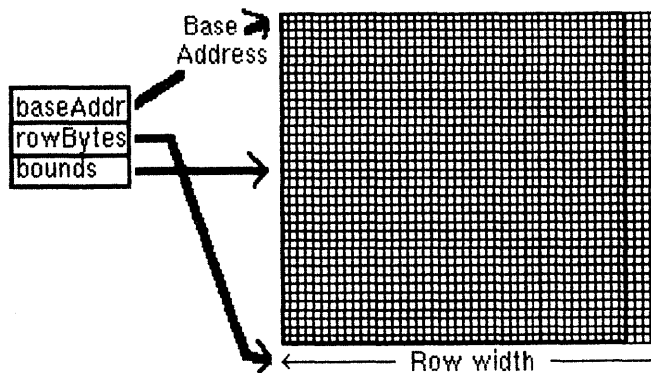

Figure E-6  
A Bitmap

The `baseAddr` field is a pointer to the beginning of the bit image in memory, and the `rowBytes` field is the number of bytes in each row of the image. Both of these should always be even: a bitmap should always begin on a word boundary and contain an integral number of words in each row.

The `bounds` field is a boundary rectangle that both encloses the active area of the bit image and imposes a coordinate system on it. The relationship between the boundary rectangle and the bit image in a bitmap is simple yet very important. First, a few general rules:

- Bits in a bit image fall between points on the coordinate plane.
- A rectangle divides a bit image into two sets of bits: those bits inside the rectangle and those outside the rectangle.
- A rectangle that is `H` points wide and `V` points tall encloses exactly  $(H-1) * (V-1)$  bits.

The top left corner of the boundary rectangle is aligned around the first bit in the bit image. The width of the rectangle determines how many bits of one row are logically owned by the bitmap; the relationship

$$8 * \text{map.rowBytes} \geq \text{map.bounds.right} - \text{map.bounds.left}$$

must always be true. The height of the rectangle determines how many rows of the image are logically owned by the bitmap. To ensure that the number of bits in the logical bitmap is not larger than the number of bits in the bit image, the bit image must be at least as big as

$$(\text{map.bounds.bottom} - \text{map.bounds.top}) * \text{map.rowBytes}$$

Normally, the boundary rectangle completely encloses the bit image: the width of the boundary rectangle is equal to the number of bits in one row of the image, and the height of the rectangle is equal to the number of rows in the image. If the rectangle is smaller than the dimensions of the image, the least significant bits in each row, as well as the last rows in the image, are not affected by any operations on the bitmap.

The bitmap also imposes a coordinate system on the image. Because bits fall between coordinate points, the coordinate system assigns integer values to the lines that border and separate bits, not to the bit positions themselves. For example, if a bitmap is assigned the boundary rectangle with corners (10,-8) and (34,8), the bottom right bit in the image will be between horizontal coordinates 33 and 34, and between vertical coordinates 7 and 8 (see Figure E-7).

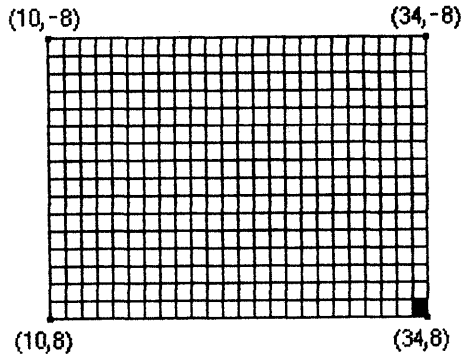

Figure E-7  
Coordinates and Bitmaps

#### E.4.3 Patterns

A pattern is a 64-bit image, organized as an 8-by-8-bit rectangle, which is used to define a repeating design (such as stripes) or tone (such as gray). Patterns can be used to draw lines and shapes or to fill areas on the screen.

When a pattern is drawn, it is aligned such that adjacent areas of the same pattern in the same graphics port will blend with each other into a continuous, coordinated pattern. QuickDraw provides the predefined patterns **white**, **black**, **gray**, **ltGray**, and **dkGray**. Any other 64-bit variable or constant can be used as a pattern, too. The data type definition for a pattern is as follows:

```
type Pattern = packed array [0..7] of 0..255;
```

The row width of a pattern is 1 byte.

#### E.4.4 Cursors

A cursor is a small image that appears on the screen and is controlled by the mouse. (It appears only on the screen, and never in an off-screen bit image.)

A cursor is defined as a 256-bit image, a 16-by-16-bit rectangle. The row width of a cursor is 2 bytes. Figure E-8 illustrates four cursors.



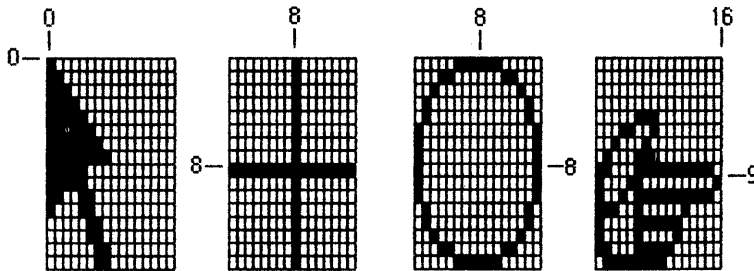

Figure E-8  
Cursors

A cursor has three fields: a 16-word data field that contains the image itself, a 16-word mask field that contains information about the screen appearance of each bit of the cursor, and a *hotspot* point that aligns the cursor with the position of the mouse.

```

type Cursor = record
    data:    array [0..15] of integer;
    mask:    array [0..15] of integer;
    hotspot: Point
end;
    
```

The data for the cursor must begin on a word boundary.

The cursor appears on the screen as a 16-by-16-bit rectangle. The appearance of each bit of the rectangle is determined by the corresponding bits in the data and mask and, if the mask bit is 0, by the pixel "under" the cursor (the one already on the screen in the same position as this bit of the cursor):

Data	Mask	Resulting pixel on screen
0	1	White
1	1	Black
0	0	Same as pixel under cursor
1	0	Inverse of pixel under cursor

Notice that if all mask bits are 0, the cursor is completely transparent, in that the image under the cursor can still be viewed: pixels under the white part of the cursor appear unchanged, while under the black part of the cursor, black pixels show through as white.

The hotspot aligns a point in the image (not a bit, a point!) with the mouse position. Imagine the rectangle with corners (0,0) and (16,16) framing the image, as in each of the examples in Figure E-8; the hotspot is defined in this coordinate system. A hotspot of (0,0) is at the top left of the image. For the arrow in Figure E-8 to point to the mouse position, (0,0) would be its hotspot. A hotspot of (8,8) is in the exact center of the image; the center of the plus

sign or oval in Figure E-8 would coincide with the mouse position if (8,8) were the hotspot for that cursor. Similarly, the hotspot for the pointing hand would be (16,9).

Whenever you move the mouse, the low-level interrupt-driven mouse routines move the cursor's hotspot to be aligned with the new mouse position.

QuickDraw supplies a predefined arrow cursor, an arrow pointing north-northwest.

Refer to Appendix F, Hardware Interface, for more information on the mouse and cursor control.

### E.5 The Drawing Environment: GrafPort

A *grafPort* is a complete drawing environment that defines how and where graphic operations will have their effect. It contains all the information about one instance of graphic output that is kept separate from all other instances. You can have many grafPorts open at once, and each one will have its own coordinate system, drawing pattern, background pattern, pen size and location, character font and style, and bitmap in which drawing takes place. You can instantly switch from one port to another. GrafPorts are the structures on which a program builds windows, which are fundamental to the Lisa's "overlapping windows" user interface.

A grafPort is a dynamic data structure, defined as follows:

```

type GrafPtr = ^GrafPort;
   GrafPort = record
       device:      integer;
       portBits:   BitMap;
       portRect:   Rect;
       visRgn:     RgnHandle;
       clipRgn:    RgnHandle;
       bkPat:      Pattern;
       fillPat:    Pattern;
       pnLoc:      Point;
       pnSize:     Point;
       pnMode:     integer;
       pnPat:      Pattern;
       pnVis:      integer;
       txFont:     integer;
       txFace:     Style;
       txMode:     integer;
       txSize:     integer;
       spExtra:    longint;
       fgColor:    longint;
       bkColor:    longint;
       colrBit:    integer;
       patStretch: integer;
       picSave:    QDHandle;

```

```

    rgnSave:    QDHandle;
    polySave:   QDHandle;
    grafProcs:  QDProcsPtr
end;
```

All QuickDraw operations refer to grafPorts via grafPtrs. You create a grafPort with the Pascal procedure `new` and use the resulting pointer in calls to QuickDraw. You could, of course, declare a static variable of type `GrafPort`, and obtain a pointer to that static structure (with the `@` operator), but as most grafPorts will be used dynamically, their data structures should be dynamic also.

---

#### NOTE

---

You can access all fields and subfields of a grafPort normally, but you should not store new values directly into them. QuickDraw has procedures for altering all fields of a grafPort, and using these procedures ensures that changing a grafPort produces no unusual side effects.

---

The `device` field of a grafPort is the number of the logical output device that the grafPort will be using. QuickDraw uses this information, since there are physical differences in the same logical font for different output devices. The default device number is 0, for the Lisa screen.

The `portBits` field is the bitmap that points to the bit image to be used by the grafPort. All drawing that is done in this grafPort will take place in this bit image. The default bitmap uses the entire Lisa screen as its bit image, with `rowBytes` of 90 and a boundary rectangle of (0,0,720,364). The bitmap may be changed to indicate a different structure in memory: all graphics procedures work in exactly the same way regardless of whether their effects are visible on the screen. A program can, for example, prepare an image to be printed on a printer without ever displaying the image on the screen, or develop a picture in an off-screen bitmap before transferring it to the screen. By altering the coordinates of the `portBits.bounds` rectangle, you can change the coordinate system of the grafPort; with a QuickDraw procedure call, you can set an arbitrary coordinate system for each grafPort, even if the different grafPorts all use the same bit image (e.g., the full screen).

The `portRect` field is a rectangle that defines a subset of the bitmap for use by the grafPort. Its coordinates are in the system defined by the `portBits.bounds` rectangle. All drawing done by the application occurs inside this rectangle. The `portRect` usually defines the "writable" interior area of a window, document, or other object on the screen. The default `portRect` is the entire screen.

The `visRgn` field indicates the region that is actually visible on the screen. It is reserved for use by future software, and should be treated as read-only.

The default `visRgn` is set to the `portRect`.

The `clipRgn` is an arbitrary region that the application can use to limit drawing to any region within the `portRect`. If, for example, you want to draw a half circle on the screen, you can set the `clipRgn` to half the square that would enclose the whole circle, and go ahead and draw the whole circle. Only the half within the `clipRgn` will actually be drawn in the `grafPort`. The default `clipRgn` is set arbitrarily large, and you have full control over its setting. Notice that unlike the `visRgn`, the `clipRgn` affects the image even if it is not displayed on the screen.

Figure E-9 illustrates a typical bitmap (as defined by `portBits`), `portRect`, `visRgn`, and `clipRgn`.

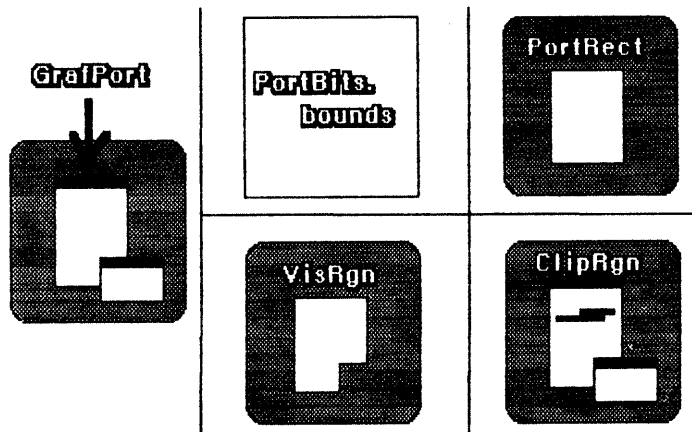

Figure E-9  
GrafPort Regions

The `bkPat` and `fillPat` fields of a `grafPort` contain patterns used by certain QuickDraw routines. `BkPat` is the "background" pattern that is used when an area is erased or when bits are scrolled out of it. When asked to fill an area with a specified pattern, QuickDraw stores the given pattern in the `fillPat` field and then calls a low-level drawing routine which gets the pattern from that field. The various graphic operations are discussed in detail later in the descriptions of individual QuickDraw routines.

Of the next ten fields, the first five determine characteristics of the graphics pen, described in Section E.5.1, and the last five determine characteristics of any text that may be drawn, described in Section E.5.2.

The `fgColor`, `bkColor`, and `colrBit` fields contain values related to drawing in color, a capability that will be available in the future when Apple supports

color output devices for the Lisa. **FgColor** is the grafPort's foreground color and **bkColor** is its background color. **ColrBit** tells the color imaging software which plane of the color picture to draw into. For more information, see Section E.7.2, Drawing in Color.

The **patStretch** field is used during output to a printer to expand patterns if necessary. The application should not change its value.

The **picSave**, **rgnSave**, and **polySave** fields reflect the state of picture, region, and polygon definition, respectively. To define a region, for example, you "open" it, call routines that draw it, and then "close" it. If no region is open, **rgnSave** contains **nil**; otherwise, it contains a handle to information related to the region definition. The application should not be concerned about exactly what information the handle leads to; you may, however, save the current value of **rgnSave**, set the field to **nil** to disable the region definition, and later restore it to the saved value to resume the region definition. The **picSave** and **polySave** fields work similarly for pictures and polygons.

Finally, the **grafProcs** field may point to a special data structure that the application stores into if it wants to customize QuickDraw drawing procedures or use QuickDraw in other advanced, highly specialized ways. (For more information, see Section E.10, Customizing QuickDraw Operations.) If **grafProcs** is **nil**, QuickDraw responds in the standard ways described in this appendix.

#### E.5.1 Pen Characteristics

The **pnLoc**, **pnSize**, **pnMode**, **pnPat**, and **pnVis** fields of a grafPort deal with the graphics pen. Each grafPort has one and only one graphics pen, which is used for drawing lines, shapes, and text. As illustrated in Figure E-10, the pen has four characteristics: a *location*, a *size*, a *drawing mode*, and a *drawing pattern*.

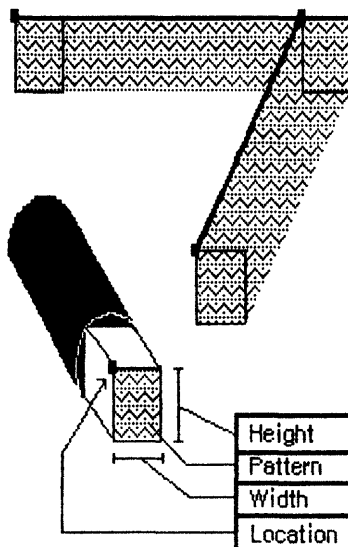

**Figure E-10**  
A Graphics Pen

The pen location (`pnLoc`) is a point in the coordinate system of the `grafPort`, and is where QuickDraw will begin drawing the next line, shape, or character. It can be anywhere on the coordinate plane: there are no restrictions on the movement or placement of the pen. Remember that the pen location is a point on the coordinate plane, not a pixel in a bit image!

The pen is rectangular in shape, and has a user-definable width and height (`pnSize`). The default size is a 1-by-1-bit rectangle; the width and height can range from (0,0) to (32767,32767). If either the pen width or the pen height is less than 1, the pen will not draw on the screen.

- The pen appears as a rectangle with its top left corner at the pen location; it hangs below and to the right of the pen location.

The `pnMode` and `pnPat` fields of a `grafPort` determine how the bits under the pen are affected when lines or shapes are drawn. The `pnPat` is a pattern that is used as the "ink" in the pen. This pattern, like all other patterns drawn in the `grafPort`, is always aligned with the port's coordinate system: the top left corner of the pattern is aligned with the top left corner of the `portRect`, so that adjacent areas of the same pattern will blend into a continuous, coordinated pattern. Five patterns are predefined (white, black, and three shades of gray); you can also create your own pattern and use it as the `pnPat`. (A utility procedure, called `StuffHex`, allows you to fill patterns easily.)

The `pnMode` field determines how the pen pattern is to affect what's already on the bitmap when lines or shapes are drawn. When the pen draws, QuickDraw first determines what bits of the bitmap will be affected and finds their corresponding bits in the pattern. It then does a bit-by-bit evaluation based on the pen mode, which specifies one of eight boolean operations to perform. The resulting bit is placed into its proper place in the bitmap. The pen modes are described in Section E.7.1, Transfer Modes.

The `pnVis` field determines the pen's visibility, that is, whether it draws on the screen. For more information, see the descriptions of `HidePen` and `ShowPen` in Section E.9.3, Pen and Line-Drawing Routines.

### E.5.2 Text Characteristics

The `txFont`, `txFace`, `txMode`, `txSize`, and `spExtra` fields of a `grafPort` determine how text will be drawn--the font, style, and size of characters and how they will be placed on the bitmap.

QuickDraw can draw characters as quickly and easily as it draws lines and shapes, and in many prepared fonts. Figure E-11 shows two QuickDraw characters and some terms you should become familiar with.

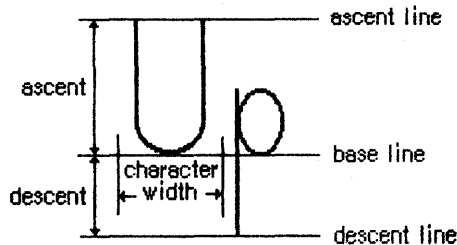

Figure E-11  
QuickDraw Characters

QuickDraw can display characters in any size, as well as boldfaced, italicized, outlined, or shadowed, all without changing fonts. It can also underline the characters, or draw them closer together or farther apart.

The `txFont` field is a font number that identifies the character font to be used in the `grafPort`. The font number 0 represents the system font, and is the default established by `OpenPort`. The unit `QDSupport` (listed in Section E.15) includes definitions of other available font numbers.

A character font is defined as a collection of bit images: these images make up the individual characters of the font. The characters can be of unequal widths, and they're not restricted to their "cells": the lower curl of a lowercase `j`, for example, can stretch back under the previous character (typographers call this *kerning*). A font can consist of up to 256 distinct characters, yet not all characters need be defined in a single font. Each font

contains a *missing symbol* to be drawn in case of a request to draw a character that is missing from the font.

The `txFace` field controls the appearance of the font with values from the set defined by the `Style` data type:

```
type StyleItem = (bold, italic, underline, outline, shadow,
                 condense, extend);
```

```
Style = set of StyleItem;
```

You can apply these either alone or in combination (see Figure E-12). Most combinations usually look good only for large fonts.

Normal Characters  
**Bold Characters**  
*Italic Characters*  
Underlined Characters xyz  
**Outlined Characters**  
**Shadowed Characters**  
 Condensed Characters  
 Extended Characters  
***Bold Italic Characters***  
**Bold Outlined Underlined**

... and in other fonts, too!

Figure E-12  
 Character Styles

If you specify **bold**, each character is repeatedly drawn one bit to the right an appropriate number of times for extra thickness.

**Italic** adds an italic slant to the characters. Character bits above the base line are skewed right; bits below the base line are skewed left.

**Underline** draws a line below the base line of the characters. If part of a character descends below the base line (as "y" in Figure E-12), the underline is not drawn through the pixel on either side of the descending part.

You may specify either **outline** or **shadow**. **Outline** makes a hollow, outlined character rather than a solid one. With **shadow**, not only is the character hollow and outlined, but the outline is thickened below and to the right of the character to achieve the effect of a shadow. If you specify **bold** along with **outline** or **shadow**, the hollow part of the character is widened.



**Condense** and **extend** affect the horizontal distance between all characters, including spaces. **Condense** decreases the distance between characters and **extend** increases it, by an amount which QuickDraw determines is appropriate.

The **txMode** field controls the way characters are placed on a bit image. It functions much like a **pmMode**: when a character is drawn, QuickDraw determines which bits of the bit image will be affected, does a bit-by-bit comparison based on the mode, and stores the resulting bits into the bit image. These modes are described in Section E.7.1, Transfer Modes. Only three of them--**srcOr**, **srcXor**, and **srcBlc**--should be used for drawing text.

The **txSize** field specifies the type size for the font, in points (where "point" here is a typographical term meaning approximately 1/72 inch). Any size may be specified. If QuickDraw does not have the font in a specified size, it will scale a size it does have as necessary to produce the size desired. A value of 0 in this field directs QuickDraw to choose the size from among those it has for the font; it will choose whichever size is closest to the system font size.

Finally, the **spExtra** field is useful when a line of characters is to be drawn justified such that it is aligned with both a left and a right margin (sometimes called "full justification"). **SpExtra** is the number of pixels by which each space character should be widened to fill out the line.

## E.6 Coordinates in GrafPorts

Each **grafPort** has its own *local* coordinate system. All fields in the **grafPort** are expressed in these coordinates, and all calculations and actions performed in QuickDraw use the local coordinate system of the currently selected port.

Two things are important to remember:

- Each **grafPort** maps a portion of the coordinate plane into a similarly-sized portion of a bit image.
- The **portBits.bounds** rectangle defines the local coordinates for a **grafPort**.

The top left corner of **portBits.bounds** is always aligned around the first bit in the bit image; the coordinates of that corner "anchor" a point on the grid to that bit in the bit image. This forms a common reference point for multiple **grafPorts** using the same bit image (such as the screen). Given a **portBits.bounds** rectangle for each port, you know that their top left corners coincide.

The interrelationship between the **portBits.bounds** and **portRect** rectangles is very important. As the **portBits.bounds** rectangle establishes a coordinate system for the port, the **portRect** rectangle indicates the section of the coordinate plane (and thus the bit image) that will be used for drawing. The **portRect** usually falls inside the **portBits.bounds** rectangle, but it's not required to do so.

When a new **grafPort** is created, its bitmap is set to point to the entire Lisa screen, and both the **portBits.bounds** and the **portRect** rectangles are set to

720-by-364-bit rectangles, with the point (0,0) at the top left corner of the screen.

You can redefine the local coordinates of the top left corner of the grafPort's **portRect**, using the **SetOrigin** procedure. This changes the local coordinate system of the grafPort, recalculating the coordinates of all points in the grafPort to be relative to the new corner coordinates. For example, consider these procedure calls:

```
SetPort(gamePort);
SetOrigin(40,80);
```

The call to **SetPort** sets the current grafPort to **gamePort**; the call to **SetOrigin** changes the local coordinates of the top left corner of that port's **portRect** to (40,80) (see Figure E-13).

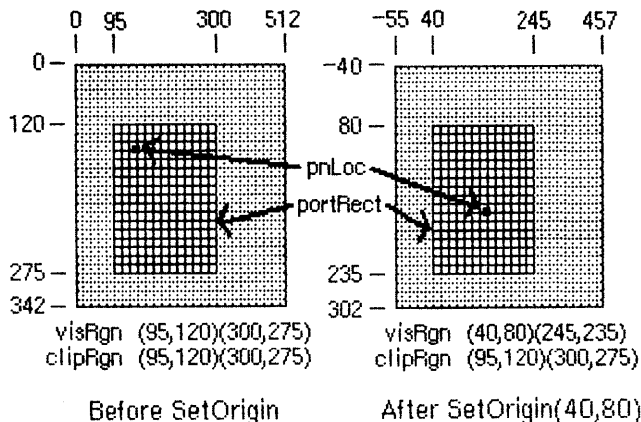

Figure E-13  
Changing Local Coordinates

This recalculates the coordinate components of the following elements:

```
gamePort^.portBits.bounds    gamePort^.portRect
gamePort^.visRgn
```

These elements are always kept "in sync", so that all calculations, comparisons, or operations that seem right, work right.

Notice that when the local coordinates of a grafPort are offset, the **visRgn** of that port is offset also, but the **clipRgn** is not. A good way to think of it is that if a document is being shown inside a grafPort, the document "sticks" to the coordinate system, and the port's structure "sticks" to the screen. Suppose, for example, that the **visRgn** and **clipRgn** in Figure E-13 before

SetOrigin are the same as the `portRect`, and a document is being shown. After the SetOrigin call, the top left corner of the `clipRgn` is still (95,120), but this location has moved down and to the right, and the location of the pen within the document has similarly moved. The locations of `portBits.bounds`, `portRect`, and `visRgn` did not change; their coordinates were offset. As always, the top left corner of `portBits.bounds` remains aligned around the first bit in the bit image (the first pixel on the screen).

If you are moving, comparing, or otherwise dealing with mathematical items in different `grafPorts` (for example, finding the intersection of two regions in two different `grafPorts`), you must adjust to a common coordinate system before you perform the operation. A QuickDraw procedure, `LocalToGlobal`, lets you convert a point's local coordinates to a *global* system where the top left corner of the bit image is (0,0); by converting the various local coordinates to global coordinates, you can compare and mix them with confidence. For more information, see the description of this procedure in Section E.9.17, *Calculations with Points*.

## E.7 General Discussion of Drawing

Drawing occurs:

- Always inside a `grafPort`, in the bit image and coordinate system defined by the `grafPort`'s bitmap.
- Always within the intersection of the `grafPort`'s `portBits.bounds` and `portRect`, and clipped to its `visRgn` and `clipRgn`.
- Always at the `grafPort`'s pen location.
- Usually with the `grafPort`'s pen size, pattern, and mode.

With QuickDraw procedures, you can draw lines, shapes, and text. Shapes include rectangles, ovals, rounded-corner rectangles, wedge-shaped sections of ovals, regions, and polygons.

Lines are defined by two points: the current pen location and a destination location. When drawing a line, QuickDraw moves the top left corner of the pen along the mathematical trajectory from the current location to the destination. The pen hangs below and to the right of the trajectory (see Figure E-14).

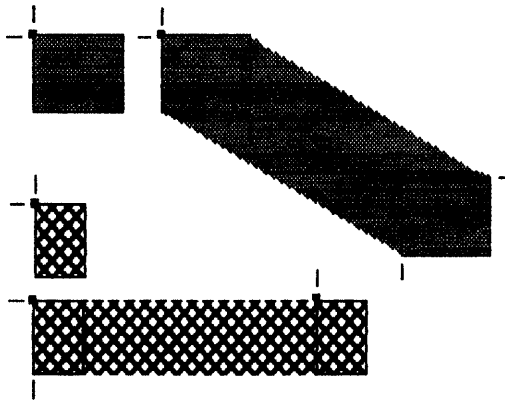

Figure E-14  
Drawing Lines

---

NOTE

No mathematical element (such as the pen location) is ever affected by clipping: clipping only determines what appears where in the bit image. If you draw a line to a location outside your grafPort, the pen location will move there, but only the portion of the line that is inside the port will actually be drawn. This is true for all drawing procedures.

---

Rectangles, ovals, and rounded-corner rectangles are defined by two corner points. The shapes always appear inside the mathematical rectangle defined by the two points. A region is defined in a more complex manner, but also appears only within the rectangle enclosing it. Remember, these enclosing rectangles have infinitely thin borders and are not visible on the screen.

As illustrated in Figure E-15, shapes may be drawn either *solid* (filled in with a pattern) or *framed* (outlined and hollow).

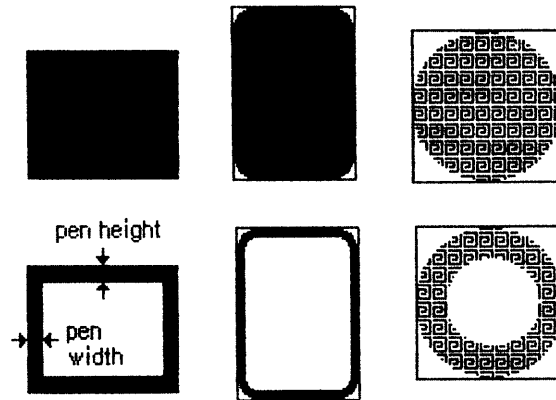

Figure E-15  
Solid Shapes and Framed Shapes

In the case of framed shapes, the outline appears completely within the enclosing rectangle--with one exception--and the vertical and horizontal thickness of the outline is determined by the pen size. The exception is polygons, as discussed in Section E.8.2, Polygons.

The pen pattern is used to fill in the bits that are affected by the drawing operation. The pen mode defines how those bits are to be affected by directing QuickDraw to apply one of eight boolean operations to the bits in the shape and the corresponding pixels on the screen.

Text drawing does not use the `pnSize`, `pnPat`, or `pnMode`, but it does use the `pnLoc`. Each character is placed to the right of the current pen location, with the left end of its base line at the pen's location. The pen is moved to the right to the location where it will draw the next character. No wrap or carriage return is performed automatically.

The method QuickDraw uses in placing text is controlled by a mode similar to the pen mode. This is explained in Section E.7.1, Transfer Modes. Clipping of text is performed in exactly the same manner as all other clipping in QuickDraw.

#### E.7.1 Transfer Modes

When lines or shapes are drawn, the `pnMode` field of the `grafPort` determines how the drawing is to appear in the port's bit image; similarly, the `txMode` field determines how text is to appear. There is also a QuickDraw procedure that transfers a bit image from one bitmap to another, and this procedure has a mode parameter that determines the appearance of the result. In all these cases, the mode, called a *transfer mode*, specifies one of eight boolean operations: for each bit in the item to be drawn, QuickDraw finds the

corresponding bit in the destination bit image, performs the boolean operation on the pair of bits, and stores the resulting bit into the bit image.

There are two types of transfer mode:

- *Pattern transfer modes*, for drawing lines or shapes with a pattern.
- *Source transfer modes*, for drawing text or transferring any bit image between two bitmaps.

For each type of mode, there are four basic operations--Copy, Or, Xor, and Bic. The Copy operation simply replaces the pixels in the destination with the pixels in the pattern or source, "painting" over the destination without regard for what is already there. The Or, Xor, and Bic operations leave the destination pixels under the white part of the pattern or source unchanged, and differ in how they affect the pixels under the black part: Or replaces those pixels with black pixels, thus "overlaying" the destination with the black part of the pattern or source; Xor inverts the pixels under the black part; and Bic erases them to white.

Each of the basic operations has a variant in which every pixel in the pattern or source is inverted before the operation is performed, giving eight operations in all. Each mode is defined by name as a constant in QuickDraw (see Figure E-16).

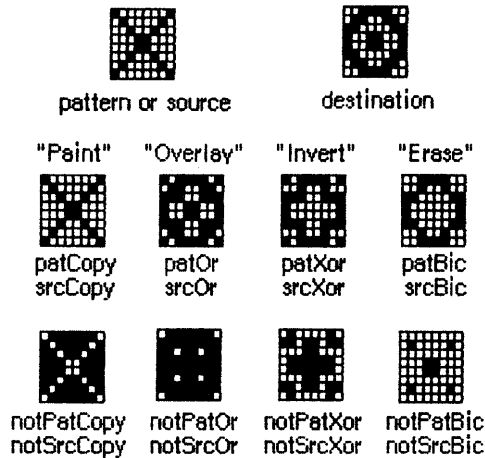

Figure E-16  
Transfer Modes

<u>Pattern transfer mode</u>	<u>Source transfer mode</u>	<u>Action on each pixel in destination:</u>	
		<u>If black pixel in pattern or source</u>	<u>If white pixel in pattern or source</u>
<b>patCopy</b>	<b>srcCopy</b>	Force black	Force white
<b>patOr</b>	<b>srcOr</b>	Force black	Leave alone
<b>patXor</b>	<b>srcXor</b>	Invert	Leave alone
<b>patBic</b>	<b>srcBic</b>	Force white	Leave alone
<b>notPatCopy</b>	<b>notSrcCopy</b>	Force white	Force black
<b>notPatOr</b>	<b>notSrcOr</b>	Leave alone	Force black
<b>notPatXor</b>	<b>notSrcXor</b>	Leave alone	Invert
<b>notPatBic</b>	<b>notSrcBic</b>	Leave alone	Force white

### E.7.2 Drawing In Color

Currently you can only look at QuickDraw output on a black-and-white screen or printer. Eventually, however, Apple will support color output devices. If you want to set up your application now to produce color output in the future, you can do so by using QuickDraw procedures to set the foreground color and the background color. Eight standard colors may be specified with the following predefined constants: **blackColor**, **whiteColor**, **redColor**, **greenColor**, **blueColor**, **cyanColor**, **magentaColor**, and **yellowColor**. Initially, the foreground color is **blackColor** and the background color is **whiteColor**. If you specify a color other than **whiteColor**, it will appear as black on a black-and-white output device.

To apply the table above (in Section E.7.1) to drawing in color, make the following translation: where the table shows "Force black", read "Force foreground color", and where it shows "Force white", read "Force background color". When you eventually receive the color output device, you'll find out the effect of inverting a color on it.

---

#### NOTE

QuickDraw can support output devices that have up to 32 bits of color information per pixel. A color picture may be thought of, then, as having up to 32 planes. At any one time, QuickDraw draws into only one of these planes. A QuickDraw routine called by the color-imaging software specifies which plane.

---

### E.8 Pictures and Polygons

QuickDraw lets you save a sequence of drawing commands and "play them back" later with a single procedure call. There are two such mechanisms: one for drawing any picture to scale in a destination rectangle that you specify, and another for drawing polygons in all the ways you can draw other shapes in QuickDraw.

### E.8.1 Pictures

A *picture* in QuickDraw is a transcript of calls to routines which draw something--anything--on a bitmap. Pictures make it easy for one program to draw something defined in another program, with great flexibility and without knowing the details about what's being drawn.

For each picture you define, you specify a rectangle that surrounds the picture; this rectangle is called the *picture frame*. When you later call the procedure that draws the saved picture, you supply a destination rectangle, and QuickDraw scales the picture so that its frame is completely aligned with the destination rectangle. Thus, the picture may be expanded or shrunk to fit its destination rectangle. For example, if the picture is a circle inside a square picture frame, and the destination rectangle is not square, the picture is drawn as an oval.

Since a picture may include any sequence of drawing commands, its data structure is a variable-length entity. It consists of two fixed fields followed by a variable-length data field:

```

type Picture = record
    picSize: integer;
    picFrame: Rect;
    {picture definition data}
end;
```

The `picSize` field contains the size, in bytes, of the picture variable. The `picFrame` field is the picture frame which surrounds the picture and gives a frame of reference for scaling when the picture is drawn. The rest of the structure contains a compact representation of the drawing commands that define the picture.

All pictures are accessed through handles, which point to one master pointer which in turn points to the picture.

```

type PicPtr = ^Picture;
PicHandle = ^PicPtr;
```

To define a picture, you call a QuickDraw function that returns a picture handle and then call the routines that draw the picture. There is a procedure to call when you've finished defining the picture, and another for when you're done with the picture altogether.

QuickDraw also allows you to intersperse *picture comments* with the definition of a picture. These comments, which do not affect the picture's appearance, may be used to provide additional information about the picture when it's played back. This is especially valuable when pictures are transmitted from one application to another. There are two standard types of



comment which, like parentheses, serve to group drawing commands together (such as all the commands that draw a particular part of a picture):

```
const picLParen = 0;  
      picRParen = 1;
```

The application defining the picture can use these standard comments as well as comments of its own design.

To include a comment in the definition of a picture, the application calls a QuickDraw procedure that specifies the comment with three parameters: the comment kind, which identifies the type of comment; a handle to additional data if desired; and the size of the additional data, if any. When playing back a picture, QuickDraw passes any comments in the picture's definition to a low-level procedure accessed indirectly through the `grafProcs` field of the `grafPort` (see Section E.10, Customizing QuickDraw Operations, for more information). To process comments, the application must include a procedure to do the processing and store a pointer to it in the data structure pointed to by the `grafProcs` field.

---

**NOTE**

---

The standard low-level procedure for processing picture comments simply ignores all comments.

---

### E.8.2 Polygons

Polygons are similar to pictures in that you define them by a sequence of calls to QuickDraw routines. They are also similar to other shapes that QuickDraw knows about, since there is a set of procedures for performing graphic operations and calculations on them.

A *polygon* is simply any sequence of connected lines (see Figure E-17). You define a polygon by moving to the starting point of the polygon and drawing lines from there to the next point, from that point to the next, and so on.

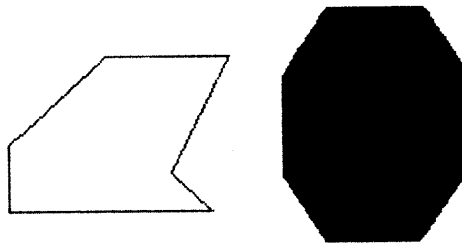

**Figure E-17**  
Polygons

The data structure for a polygon is a variable-length entity. It consists of two fixed fields followed by a variable-length array:

```

type Polygon = record
    polySize: integer;
    polyBBox: Rect;
    polyPoints: array [0..0] of Point
end;

```

The `polySize` field contains the size, in bytes, of the polygon variable. The `polyBBox` field is a rectangle which just encloses the entire polygon. The `polyPoints` array expands as necessary to contain the points of the polygon--the starting point followed by each successive point to which a line is drawn.

Like pictures and regions, polygons are accessed through handles.

```

type PolyPtr = ^Polygon;
    PolyHandle = ^PolyPtr;

```

To define a polygon, you call a QuickDraw function that returns a polygon handle and then form the polygon by calling procedures that draw lines. You call a procedure when you've finished defining the polygon, and another when you're done with the polygon altogether.

Just as for other shapes that QuickDraw knows about, there is a set of graphic operations on polygons to draw them on the screen. QuickDraw draws a polygon by moving to the starting point and then drawing lines to the remaining points in succession, just as when the routines were called to define the polygon. In this sense it "plays back" those routine calls. As a result, polygons are not treated exactly the same as other QuickDraw shapes. For example, the procedure that frames a polygon draws outside the actual boundary of the polygon, because QuickDraw line-drawing routines draw below and to the right of the pen location. The procedures that fill a polygon with a pattern, however, stay within the boundary of the polygon; they also add an additional line between the ending point and the starting point if those points are not the same, to complete the shape.

There is also a difference in the way QuickDraw scales a polygon and a similarly-shaped region if it's being drawn as part of a picture: when stretched, a slanted line is drawn more smoothly if it's part of a polygon rather than a region. You may find it helpful to keep in mind the conceptual difference between polygons and regions: a polygon is treated more as a continuous shape, a region more as a set of bits.

## E.9 QuickDraw Routines

This section describes all the procedures and functions in QuickDraw, their parameters, and their operation. They are presented in their Pascal form; for information on using them from assembly language, see Section E.11, Using QuickDraw from Assembly Language. Note that the actual procedure and function declarations are given here, rather than the BNF notation or syntax diagrams used elsewhere in this manual.

## E.9.1 GrafPort Routines

**Procedure InitGraf (globalPtr: QDPtr);**

InitGraf initializes QuickDraw. It is called by the QDSupport unit's QDInit routine; you need not call it again. It initializes the QuickDraw global variables listed below.

<u>Variable</u>	<u>Type</u>	<u>Initial setting</u>
thePort	GrafPtr	nil
white	Pattern	all-white pattern
black	Pattern	all-black pattern
gray	Pattern	50% gray pattern
ltGray	Pattern	25% gray pattern
dkGray	Pattern	75% gray pattern
arrow	Cursor	pointing arrow cursor
screenBits	Bitmap	Lisa screen, (0,0,720,364)
randSeed	longint	1

The `globalPtr` parameter tells QuickDraw where to store its global variables, beginning with `thePort`. From Pascal programs, this parameter should always be set to `@thePort`; assembly-language programmers may choose any location, as long as it can accommodate the number of bytes specified by `GRAFSIZE` in `GRAFTYPES.TEXT` (see Section E.11, Using QuickDraw from Assembly Language).

---

**NOTE**

---

To initialize the cursor, call `InitCursor` (described in Section E.9.2, `Cursor-Handling Routines`).

---

**Procedure OpenPort (gp: GrafPtr);**

`OpenPort` allocates space for the given `grafPort`'s `visRgn` and `clipRgn`, initializes the fields of the `grafPort` as indicated below, and makes the `grafPort` the current port (see `SetPort`, below). You must call `OpenPort` before using any `grafPort`; first create a `grafPtr` with `new`, then use that `grafPtr` in the `OpenPort` call.

<u>Field</u>	<u>Type</u>	<u>Initial setting</u>
device	integer	0 (Lisa screen)
portBits	BitMap	screenBits (see InitGraf)
portRect	Rect	screenBits.bounds (0,0,720,364)
visRgn	RgnHandle	handle to the rectangular region (0,0,720,364)
clipRgn	RgnHandle	handle to the rectangular region (-30000, -30000, 30000, 30000)
bkPat	Pattern	white
fillPat	Pattern	black
pnLoc	Point	(0,0)
pnSize	Point	(1,1)
pnMode	integer	patCopy
pnPat	Pattern	black
pnVis	integer	0 (visible)
txFont	integer	0 (system font)
txFace	Style	normal
txMode	integer	srcOr
txSize	integer	0 (QuickDraw decides)
spExtra	longint	0
fgColor	longint	blackColor
bkColor	longint	whiteColor
colrBit	integer	0
patStretch	integer	0
picSave	QDHandle	nil
rgnSave	QDHandle	nil
polySave	QDHandle	nil
grafProcs	QDProcsPtr	nil

#### Procedure InitPort (gp: GrafPtr);

Given a pointer to a grafPort that has been opened with OpenPort, InitPort reinitializes the fields of the grafPort and makes it the current port (if it's not already).

---

#### NOTE

InitPort does everything OpenPort does except allocate space for the visRgn and clipRgn.

---

#### Procedure ClosePort (gp: GrafPtr);

ClosePort deallocates the space occupied by the given grafPort's visRgn and clipRgn. When you are completely through with a grafPort, call this procedure.

---

**WARNINGS**

---

If you do not call `ClosePort` before disposing of the `grafPort`, the memory used by the `visRgn` and `clipRgn` will be unrecoverable.

After calling `ClosePort`, be sure not to use any copies of the `visRgn` or `clipRgn` handles that you may have made.

---

**Procedure SetPort (gp: GrafPtr);**

`SetPort` sets the `grafPort` indicated by `gp` to be the current port. The global pointer `thePort` always points to the current port. All QuickDraw drawing routines affect the bitmap `thePort^.portBits` and use the local coordinate system of `thePort`. Note that `OpenPort` and `InitPort` do a `SetPort` to the given port.

---

**WARNING**

---

Never do a `SetPort` to a port that has not been opened with `OpenPort`.

---

Each port possesses its own pen and text characteristics which remain unchanged when the port is not selected as the current port.

**Procedure GetPort (var gp: GrafPtr);**

`GetPort` returns a pointer to the current `grafPort`. If you have a program that draws into more than one `grafPort`, it's extremely useful to have each procedure save the current `grafPort` (with `GetPort`), set its own `grafPort`, do drawing or calculations, and then restore the previous `grafPort` (with `SetPort`). The pointer to the current `grafPort` is also available through the global pointer `thePort`, but you may prefer to use `GetPort` for better readability of your program text. For example, a procedure could do a `GetPort(savePort)` before setting its own `grafPort` and a `SetPort(savePort)` afterwards to restore the previous port.

**Procedure GrafDevice (device: Integer);**

`GrafDevice` sets `thePort^.device` to the given number, which identifies the logical output device for this `grafPort`. QuickDraw uses this information. The initial device number is 0, which represents the Lisa screen.

**Procedure SetPortBits (bm: Bitmap);**

`SetPortBits` sets `thePort^.portBits` to any previously defined bitmap. This allows you to perform all normal drawing and calculations on a buffer other than the Lisa screen—for example, a 640-by-8 output buffer for a dot matrix printer, or a small off-screen image for later "stamping" onto the screen.

Remember to prepare all fields of the bitmap before you call SetPortBits.

**Procedure PortSize (width,height: integer);**

PortSize changes the size of the current grafPort's portRect. *This does not affect the screen;* it merely changes the size of the "active area" of the grafPort.

The top left corner of the portRect remains at its same location; the width and height of the portRect are set to the given width and height. In other words, PortSize moves the bottom right corner of the portRect to a position relative to the top left corner.

PortSize does not change the clipRgn or the visRgn, nor does it affect the local coordinate system of the grafPort; it changes only the portRect's width and height. Remember that all drawing occurs only in the intersection of the portBits.bounds and the portRect, clipped to the visRgn and the clipRgn.

**Procedure MovePortTo (leftGlobal,topGlobal: integer);**

MovePortTo changes the position of the current grafPort's portRect. *This does not affect the screen;* it merely changes the location at which subsequent drawing inside the port will appear.

The leftGlobal and topGlobal parameters set the distance between the top left corner of the portBits.bounds and the top left corner of the new portRect. For example,

**MovePortTo(360,182);**

will move the top left corner of the portRect to the center of the screen (if portBits is the Lisa screen) regardless of the local coordinate system.

Like PortSize, MovePortTo does not change the clipRgn or the visRgn, nor does it affect the local coordinate system of the grafPort.

**Procedure SetOrigin (h,v: integer);**

SetOrigin changes the local coordinate system of the current grafPort. *This does not affect the screen;* it does, however, affect where subsequent drawing and calculation will appear in the grafPort. SetOrigin updates the coordinates of the portBits.bounds, the portRect, and the visRgn. All subsequent drawing and calculation routines will use the new coordinate system.

The h and v parameters set the coordinates of the top left corner of the portRect. All other coordinates are calculated from this point. All relative distances among any elements in the port will remain the same; only their absolute local coordinates will change.

---

**NOTE**

---

SetOrigin does not update the coordinates of the clipRgn or the pen; these items stick to the coordinate system (unlike the port's structure, which sticks to the screen).

---

SetOrigin is useful for adjusting the coordinate system after a scrolling operation. (See ScrollRect in Section E.9.13, Bit Transfer Operations.)

**Procedure SetClip (rgn: RgnHandle);**

SetClip changes the clipping region of the current grafPort to a region equivalent to the given region. Note that this does not change the region handle, but affects the clipping region itself. Since SetClip makes a copy of the given region, any subsequent changes you make to that region will not affect the clipping region of the port.

You can set the clipping region to any arbitrary region, to aid you in drawing inside the grafPort. The initial clipRgn is an arbitrarily large rectangle.

**Procedure GetClip (rgn: RgnHandle);**

GetClip changes the given region to a region equivalent to the clipping region of the current grafPort. This is the reverse of what SetClip does. Like SetClip, it does not change the region handle.

**Procedure ClipRect (r: Rect);**

ClipRect changes the clipping region of the current grafPort to a rectangle equivalent to given rectangle. Note that this does not change the region handle, but affects the region itself.

**Procedure BackPat (pat: Pattern);**

BackPat sets the background pattern of the current grafPort to the given pattern. The background pattern is used in ScrollRect and in all QuickDraw routines that perform an "erase" operation.

**E.9.2 Cursor-Handling Routines**

Additional information on cursor handling can be found in Appendix F, Hardware Interface.

**Procedure InitCursor;**

InitCursor sets the current cursor to the predefined **arrow** cursor, an arrow pointing north-northwest, and sets the *cursor level* to 0, making the cursor visible. The cursor level, which is initialized to 0 when the system is booted, keeps track of the number of times the cursor has been hidden to compensate for nested calls to HideCursor and ShowCursor (below).

Before you call `InitCursor`, the cursor is undefined (or, if set by a previous process, it's whatever that process set it to).

**Procedure `SetCursor` (`crsr: Cursor`);**

`SetCursor` sets the current cursor to the 16-by-16-bit image in `crsr`. If the cursor is hidden, it remains hidden and will attain the new appearance when it's uncovered; if the cursor is already visible, it changes to the new appearance immediately.

The cursor image is initialized by `InitCursor` to a north-northwest arrow, visible on the screen. There is no way to retrieve the current cursor image.

**Procedure `HideCursor`;**

`HideCursor` removes the cursor from the screen, restoring the bits under it, and decrements the cursor level (which `InitCursor` initialized to 0). Every call to `HideCursor` should be balanced by a subsequent call to `ShowCursor`.

**Procedure `ShowCursor`;**

`ShowCursor` increments the cursor level, which may have been decremented by `HideCursor`, and displays the cursor on the screen if the level becomes 0. A call to `ShowCursor` should balance each previous call to `HideCursor`. The level is not incremented beyond 0, so extra calls to `ShowCursor` don't hurt.

If the cursor has been changed (with `SetCursor`) while hidden, `ShowCursor` presents the new cursor.

The cursor is initialized by `InitCursor` to a north-northwest arrow, not hidden.

**Procedure `ObscureCursor`;**

`ObscureCursor` hides the cursor until the next time the mouse is moved. Unlike `HideCursor`, it has no effect on the cursor level and must not be balanced by a call to `ShowCursor`.

### **E.9.3 Pen and Line-Drawing Routines**

The pen and line-drawing routines all depend on the coordinate system of the current `grafPort`. Remember that each `grafPort` has its own pen; if you draw in one `grafPort`, change to another, and return to the first, the pen will have remained in the same location.

**Procedure `HidePen`;**

`HidePen` decrements the current `grafPort`'s `pnVis` field, which is initialized to 0 by `OpenPort`; whenever `pnVis` is negative, the pen does not draw on the screen. `pnVis` keeps track of the number of times the pen has been hidden to compensate for nested calls to `HidePen` and `ShowPen` (below). `HidePen` is



called by `OpenRgn`, `OpenPicture`, and `OpenPoly` so that you can define regions, pictures, and polygons without drawing on the screen.

**Procedure ShowPen;**

`ShowPen` increments the current `grafPort`'s `pnVis` field, which may have been decremented by `HidePen`; if `pnVis` becomes 0, `QuickDraw` resumes drawing on the screen. Extra calls to `ShowPen` will increment `pnVis` beyond 0, so every call to `ShowPen` should be balanced by a subsequent call to `HidePen`. `ShowPen` is called by `CloseRgn`, `ClosePicture`, and `ClosePoly`.

**Procedure GetPen (var pt: Point);**

`GetPen` returns the current pen location, in the local coordinates of the current `grafPort`.

**Procedure GetPenState (var pnState: PenState);**

`GetPenState` saves the pen location, size, pattern, and mode in a storage variable, to be restored later with `SetPenState` (below). This is useful when calling short subroutines that operate in the current port but must change the graphics pen: each such procedure can save the pen's state when it's called, do whatever it needs to do, and restore the previous pen state immediately before returning.

The `PenState` data type is not useful for anything except saving the pen's state.

**Procedure SetPenState (pnState: PenState);**

`SetPenState` sets the pen location, size, pattern, and mode in the current `grafPort` to the values stored in `pnState`. This is usually called at the end of a procedure that has altered the pen parameters and wants to restore them to their state at the beginning of the procedure. (See `GetPenState`, above.)

**Procedure PenSize (width,height: Integer);**

`PenSize` sets the dimensions of the graphics pen in the current `grafPort`. All subsequent calls to `Line`, `LineTo`, and the procedures that draw framed shapes in the current `grafPort` will use the new pen dimensions.

The pen dimensions can be accessed in the variable `thePort^.pnSize`, which is of type `Point`. If either of the pen dimensions is set to a negative value, the pen assumes the dimensions (0,0) and no drawing is performed. For a discussion of how the pen draws, see Section E.7, General Discussion of Drawing.

**Procedure PenMode (mode: integer);**

PenMode sets the transfer mode through which the `pnPat` is transferred onto the bitmap when lines or shapes are drawn. The mode may be any one of the pattern transfer modes:

<code>patCopy</code>	<code>patXor</code>	<code>notPatCopy</code>	<code>notPatXor</code>
<code>patOr</code>	<code>patB1c</code>	<code>notPatOr</code>	<code>notPatB1c</code>

If the mode is one of the source transfer modes (or negative), no drawing is performed. The current pen mode can be obtained in the variable `thePort.pnMode`. The initial pen mode is `patCopy`, in which the pen pattern is copied directly to the bitmap.

**Procedure PenPat (pat: Pattern);**

PenPat sets the pattern that is used by the pen in the current `grafPort`. The standard patterns `white`, `black`, `gray`, `ltGray`, and `dkGray` are predefined; the initial pen pattern is `black`. The current pen pattern can be obtained in the variable `thePort.pnPat`, and this value can be assigned (but not compared!) to any other variable of type `Pattern`.

**Procedure PenNormal;**

PenNormal resets the initial state of the pen in the current `grafPort`, as follows:

<u>Field</u>	<u>Setting</u>
<code>pnSize</code>	(1,1)
<code>pnMode</code>	<code>patCopy</code>
<code>pnPat</code>	<code>black</code>

The pen location is not changed.

**Procedure MoveTo (h,v: integer);**

MoveTo moves the pen to location `(h,v)` in the local coordinates of the current `grafPort`. No drawing is performed.

**Procedure Move (dh,dv: integer);**

Move moves the pen a distance of `dh` horizontally and `dv` vertically from its current location; it calls `MoveTo(h+dh,v+dv)`, where `(h,v)` is the current location. The positive directions are to the right and down. No drawing is performed.

**Procedure LineTo (h, v: integer);**

LineTo draws a line from the current pen location to the location specified (in local coordinates) by *h* and *v*. The new pen location is (*h,v*) after the line is drawn. See Section E.7, General Discussion of Drawing.

If a region or polygon is open and being formed, its outline is infinitely thin and is not affected by the *pnSize*, *pnMode*, or *pnPat*. (See *OpenRgn* and *OpenPoly*.)

**Procedure Line (dh, dv: integer);**

Line draws a line to the location that is a distance of *dh* horizontally and *dv* vertically from the current pen location; it calls *LineTo(h+dh,v+dv)*, where (*h,v*) is the current location. The positive directions are to the right and down.

The pen location becomes the coordinates of the end of the line after the line is drawn. See Section E.7, General Discussion of Drawing.

If a region or polygon is open and being formed, its outline is infinitely thin and is not affected by the *pnSize*, *pnMode*, or *pnPat*. (See *OpenRgn* and *OpenPoly*.)

**E.9.4 Text-Drawing Routines**

Each *grafPort* has its own text characteristics, and all these procedures deal with those of the current port.

**Procedure TextFont (font: integer);**

TextFont sets the current *grafPort*'s font (*thePort^.txFont*) to the given font number. The initial font number is 0, which represents the system font. For other font numbers, refer to the *QDSupport* unit, listed in Section E.15.

**Procedure TextFace (face: Style);**

TextFace sets the current *grafPort*'s character style (*thePort^.txFace*). The *Style* data type allows you to specify a set of one or more of the following predefined constants: *bold*, *italic*, *underline*, *outline*, *shadow*, *condense*, and *extend*. For example:

TextFace([bold]);	{bold}
TextFace([bold, italic]);	{bold and italic}
TextFace(thePort^.txFace+[bold]);	{whatever it was plus bold}
TextFace(thePort^.txFace-[bold]);	{whatever it was but not bold}
TextFace([]);	{normal}

**Procedure TextMode (mode: integer);**

TextMode sets the current grafPort's transfer mode for drawing text (`thePort^.txMode`). The mode should be `srcOr`, `srcXor`, or `srcBic`. The initial transfer mode for drawing text is `srcOr`.

**Procedure TextSize (size: integer);**

TextSize sets the current grafPort's type size (`thePort^.txSize`) to the given number of points. Any size may be specified, but the result will look best if QuickDraw has the font in that size (otherwise it will scale a size it does have). The next best result will occur if the given size is an even multiple of a size available for the font. If 0 is specified, QuickDraw will choose one of the available sizes--whichever is closest to the system font size. The initial `txSize` setting is 0.

**Procedure SpaceExtra (extra: integer);**

SpaceExtra sets the current grafPort's `spExtra` field, which specifies the number of pixels by which to widen each space in a line of text. This is useful when text is being fully justified (that is, aligned with both a left and a right margin). Consider, for example, a line that contains three spaces; if there would normally be six pixels between the end of the line and the right margin, you would call `SpaceExtra(2)` to print the line with full justification. The initial `spExtra` setting is 0.

---

**NOTE**

---

SpaceExtra will also take a negative argument, but be careful not to narrow spaces so much that the text is unreadable.

---

**Procedure DrawChar (ch: char);**

DrawChar places the given character to the right of the pen location, with the left end of its base line at the pen's location, and advances the pen accordingly. If the character is not in the font, the font's missing symbol is drawn.

**Procedure DrawString (s: Str255);**

DrawString performs consecutive calls to DrawChar for each character in the supplied string; the string is placed beginning at the current pen location and extending right. No formatting (carriage returns, line feeds, etc.) is performed by QuickDraw. The pen location ends up to the right of the last character in the string.

**Procedure DrawText (textBuf: QDPtr; firstByte,byteCount: integer);**

DrawText draws text from an arbitrary structure in memory specified by **textBuf**, starting **firstByte** bytes into the structure and continuing for **byteCount** bytes. The string of text is placed beginning at the current pen location and extending right. No formatting (carriage returns, line feeds, etc.) is performed by QuickDraw. The pen location ends up to the right of the last character in the string.

**Function CharWidth (ch: char) : integer;**

CharWidth returns the value that will be added to the pen horizontal coordinate if the specified character is drawn. CharWidth includes the effects of the stylistic variations set with TextFace; if you change these after determining the character width but before actually drawing the character, the predetermined width may not be correct. If the character is a space, CharWidth also includes the effect of SpaceExtra.

**Function StringWidth (s: Str255) : integer;**

StringWidth returns the width of the given text string, which it calculates by adding the widths of all the characters in the string (see CharWidth, above). This value will be added to the pen horizontal coordinate if the specified string is drawn.

**Function TextWidth (textBuf: QDPtr; firstByte,byteCount: integer) : integer;**

TextWidth returns the width of the text stored in the arbitrary structure in memory specified by **textBuf**, starting **firstByte** bytes into the structure and continuing for **byteCount** bytes. It calculates the width by adding the widths of all the characters in the text. (See CharWidth, above.)

**Procedure GetFontInfo (var info: FontInfo);**

GetFontInfo returns the following information about the current grafPort's character font, taking into consideration the style and size in which the characters will be drawn: the ascent, descent, maximum character width (the greatest distance the pen will move when a character is drawn), and leading (the vertical distance between the descent line and the ascent line below it), all in pixels. The FontInfo data structure is defined as:

```
type FontInfo = record
    ascent: integer;
    descent: integer;
    widthMax: integer;
    leading: integer
end;
```

### E.9.5 Drawing in Color

These routines will enable applications to do color drawing in the future when Apple supports color output devices for the Lisa. All nonwhite colors will appear as black on black-and-white output devices.

#### Procedure ForeColor (color: longint);

ForeColor sets the foreground color for all drawing in the current grafPort (`thePort^.fgColor`) to the given color. The following standard colors are predefined: `blackColor`, `whiteColor`, `redColor`, `greenColor`, `blueColor`, `cyanColor`, `magentaColor`, and `yellowColor`. The initial foreground color is `blackColor`.

#### Procedure BackColor (color: longint);

BackColor sets the background color for all drawing in the current grafPort (`thePort^.bkColor`) to the given color. Eight standard colors are predefined (see ForeColor, above). The initial background color is `whiteColor`.

#### Procedure ColorBit (whichBit: integer);

ColorBit is called by printing software for a color printer, or other color-imaging software, to set the current grafPort's `colorBit` field to `whichBit`; this tells QuickDraw which plane of the color picture to draw into. QuickDraw will draw into the plane corresponding to bit number `whichBit`. Since QuickDraw can support output devices that have up to 32 bits of color information per pixel, the possible range of values for `whichBit` is 0 through 31. The initial value of the `colorBit` field is 0.

### E.9.6 Calculations with Rectangles

Calculation routines are independent of the current coordinate system; a calculation will operate the same regardless of which grafPort is active.

---

#### NOTE

Remember that if the parameters to one of the calculation routines were defined in different grafPorts, you must first adjust them to be in the same coordinate system. If you do not adjust them, the result returned by the routine may be different from what you see on the screen. To adjust to a common coordinate system, see `LocalToGlobal` and `GlobalToLocal` in Section E.9.17, Calculations with Points.

---

#### Procedure SetRect (var r: Rect; left,top,right,bottom: integer);

SetRect assigns the four boundary coordinates to the rectangle. The result is a rectangle with coordinates (`left,top,right,bottom`).

This procedure is supplied as a utility to help you shorten your program text. If you want a more readable text at the expense of length, you can assign

Integers (or points) directly into the rectangle's fields. There is no significant code size or execution speed advantage to either method; one's just easier to write, and the other's easier to read.

**Procedure OffsetRect (var r: Rect; dh,dv: integer);**

OffsetRect moves the rectangle by adding **dh** to each horizontal coordinate and **dv** to each vertical coordinate. If **dh** and **dv** are positive, the movement is to the right and down; if either is negative, the corresponding movement is in the opposite direction. The rectangle retains its shape and size; it's merely moved on the coordinate plane. This does not affect the screen unless you subsequently call a routine to draw within the rectangle.

**Procedure InsetRect (var r: Rect; dh,dv: integer);**

InsetRect shrinks or expands the rectangle. The left and right sides are moved in by the amount specified by **dh**; the top and bottom are moved toward the center by the amount specified by **dv**. If **dh** or **dv** is negative, the appropriate pair of sides is moved outward instead of inward. The effect is to alter the size by  $2*dh$  horizontally and  $2*dv$  vertically, with the rectangle remaining centered in the same place on the coordinate plane.

If the resulting width or height becomes less than 1, the rectangle is set to the empty rectangle (0,0,0,0).

**Function SectRect (srcRectA,srcRectB: Rect; var dstRect: Rect) : boolean;**

SectRect calculates the rectangle that is the intersection of the two input rectangles, and returns **true** if they indeed intersect or **false** if they do not. Rectangles that "touch" at a line or a point are not considered intersecting, because their intersection rectangle (really, in this case, an intersection line or point) does not enclose any bits on the bitmap.

If the rectangles do not intersect, the destination rectangle is set to (0,0,0,0). SectRect works correctly even if one of the source rectangles is also the destination.

**Procedure UnionRect (srcRectA,srcRectB: Rect; var dstRect: Rect);**

UnionRect calculates the smallest rectangle which encloses both input rectangles. It works correctly even if one of the source rectangles is also the destination.

**Function PtInRect (pt: Point; r: Rect) : boolean;**

PtInRect determines whether the pixel below and to the right of the given coordinate point is enclosed in the specified rectangle, and returns **true** if so or **false** if not.

**Procedure Pt2Rect (ptA, ptB: Point; var dstRect: Rect);**

Pt2Rect returns the smallest rectangle which encloses the two input points.

**Procedure PtToAngle (r: Rect; pt: Point; var angle: integer);**

PtToAngle calculates an integer angle between a line from the center of the rectangle to the given point and a line from the center of the rectangle pointing straight up (12 o'clock high). The angle is in degrees from 0 to 359, measured clockwise from 12 o'clock, with 90° at 3 o'clock, 180° at 6 o'clock, and 270° at 9 o'clock. Other angles are measured relative to the rectangle: If the line to the given point goes through the top right corner of the rectangle, the angle returned is 45 degrees, even if the rectangle is not square; if it goes through the bottom right corner, the angle is 135 degrees, and so on (see Figure E-18).

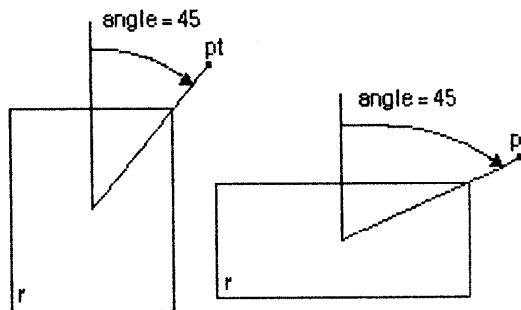

**Figure E-18**  
**PtToAngle**

The angle returned might be used as input to one of the procedures that manipulate arcs and wedges, as described in Section E.9.10, Graphic Operations on Arcs and Wedges.

**Function EqualRect (rectA, rectB: Rect) : boolean;**

EqualRect compares the two rectangles and returns **true** if they are equal or **false** if not. The two rectangles must have identical boundary coordinates to be considered equal.



**Function EmptyRect (r: Rect) : boolean;**

EmptyRect returns **true** if the given rectangle is an empty rectangle or **false** if not. A rectangle is considered empty if the bottom coordinate is equal to or less than the top or the right coordinate is equal to or less than the left.

### E.9.7 Graphic Operations on Rectangles

These procedures perform graphic operations on rectangles. See also ScrollRect in Section E.9.13, Bit Transfer Operations.

**Procedure FrameRect (r: Rect);**

FrameRect draws an outline just inside the specified rectangle, using the current grafPort's pen pattern, mode, and size. The outline is as wide as the pen width and as tall as the pen height. It is drawn with the pnPat, according to the pattern transfer mode specified by pnMode. The pen location is not changed by this procedure.

If a region is open and being formed, the outside outline of the new rectangle is mathematically added to the region's boundary.

**Procedure PaintRect (r: Rect);**

PaintRect paints the specified rectangle with the current grafPort's pen pattern and mode. The rectangle on the bitmap is filled with the pnPat, according to the pattern transfer mode specified by pnMode. The pen location is not changed by this procedure.

**Procedure EraseRect (r: Rect);**

EraseRect paints the specified rectangle with the current grafPort's background pattern bkPat (in patCopy mode). The grafPort's pnPat and pnMode are ignored; the pen location is not changed.

**Procedure InvertRect (r: Rect);**

InvertRect inverts the pixels enclosed by the specified rectangle: every white pixel becomes black and every black pixel becomes white. The grafPort's pnPat, pnMode, and bkPat are all ignored; the pen location is not changed.

**Procedure FillRect (r: Rect; pat: Pattern);**

FillRect fills the specified rectangle with the given pattern (in patCopy mode). The grafPort's pnPat, pnMode, and bkPat are all ignored; the pen location is not changed.

**E.9.8 Graphic Operations on Ovals**

- Ovals are drawn inside rectangles that you specify. If the rectangle you specify is square, QuickDraw draws a circle.

**Procedure FrameOval (r: Rect);**

FrameOval draws an outline just inside the oval that fits inside the specified rectangle, using the current grafPort's pen pattern, mode, and size. The outline is as wide as the pen width and as tall as the pen height. It is drawn with the **pnPat**, according to the pattern transfer mode specified by **pnMode**. The pen location is not changed by this procedure.

If a region is open and being formed, the outside outline of the new oval is mathematically added to the region's boundary.

**Procedure PaintOval (r: Rect);**

PaintOval paints an oval just inside the specified rectangle with the current grafPort's pen pattern and mode. The oval on the bitmap is filled with the **pnPat**, according to the pattern transfer mode specified by **pnMode**. The pen location is not changed by this procedure.

**Procedure EraseOval (r: Rect);**

EraseOval paints an oval just inside the specified rectangle with the current grafPort's background pattern **bkPat** (in **patCopy** mode). The grafPort's **pnPat** and **pnMode** are ignored; the pen location is not changed.

**Procedure InvertOval (r: Rect);**

InvertOval inverts the pixels enclosed by an oval just inside the specified rectangle: every white pixel becomes black and every black pixel becomes white. The grafPort's **pnPat**, **pnMode**, and **bkPat** are all ignored; the pen location is not changed.

**Procedure FillOval (r: Rect; pat: Pattern);**

FillOval fills an oval just inside the specified rectangle with the given pattern (in **patCopy** mode). The grafPort's **pnPat**, **pnMode**, and **bkPat** are all ignored; the pen location is not changed.

**E.9.9 Graphic Operations on Rounded-Corner Rectangles****Procedure FrameRoundRect (r: Rect; ovalWidth, ovalHeight: Integer);**

FrameRoundRect draws an outline just inside the specified rounded-corner rectangle, using the current grafPort's pen pattern, mode, and size. **OvalWidth** and **ovalHeight** specify the diameters of curvature for the corners (see Figure E-19). The outline is as wide as the pen width and as tall as the pen height.

It is drawn with the **pnPat**, according to the pattern transfer mode specified by **pnMode**. The pen location is not changed by this procedure.

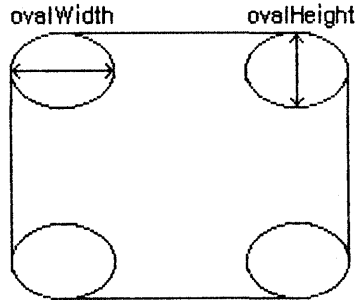

**Figure E-19**  
**Rounded-Corner Rectangle**

If a region is open and being formed, the outside outline of the new rounded-corner rectangle is mathematically added to the region's boundary.

**Procedure PaintRoundRect (r: Rect; ovalWidth, ovalHeight: integer);**

**PaintRoundRect** paints the specified rounded-corner rectangle with the current grafPort's pen pattern and mode. **OvalWidth** and **ovalHeight** specify the diameters of curvature for the corners. The rounded-corner rectangle on the bitmap is filled with the **pnPat**, according to the pattern transfer mode specified by **pnMode**. The pen location is not changed by this procedure.

**Procedure EraseRoundRect (r: Rect; ovalWidth, ovalHeight: integer);**

**EraseRoundRect** paints the specified rounded-corner rectangle with the current grafPort's background pattern **bkPat** (in **patCopy** mode). **OvalWidth** and **ovalHeight** specify the diameters of curvature for the corners. The grafPort's **pnPat** and **pnMode** are ignored; the pen location is not changed.

**Procedure InvertRoundRect (r: Rect; ovalWidth, ovalHeight: integer);**

**InvertRoundRect** inverts the pixels enclosed by the specified rounded-corner rectangle: every white pixel becomes black and every black pixel becomes white. **OvalWidth** and **ovalHeight** specify the diameters of curvature for the corners. The grafPort's **pnPat**, **pnMode**, and **bkPat** are all ignored; the pen location is not changed.

**Procedure FillRoundRect** (r: Rect; ovalWidth, ovalHeight: integer; pat: Pattern);

FillRoundRect fills the specified rounded-corner rectangle with the given pattern (in patCopy mode). OvalWidth and ovalHeight specify the diameters of curvature for the corners. The grafPort's pnPat, pnMode, and bkPat are all ignored; the pen location is not changed.

**E.9.10 Graphic Operations on Arcs and Wedges**

These procedures perform graphic operations on arcs and wedge-shaped sections of ovals. See also PtToAngle in Section E.9.6, Calculations with Rectangles.

**Procedure FrameArc** (r: Rect; startAngle, arcAngle: integer);

FrameArc draws an arc of the oval that fits inside the specified rectangle, using the current grafPort's pen pattern, mode, and size. StartAngle indicates where the arc begins and is treated mod 360. ArcAngle defines the extent of the arc. The angles are given in positive or negative degrees; a positive angle goes clockwise, while a negative angle goes counterclockwise. Zero degrees is at 12 o'clock high, 90° (or -270°) is at 3 o'clock, 180° (or -180°) is at 6 o'clock, and 270° (or -90°) is at 9 o'clock. Other angles are measured relative to the enclosing rectangle: a line from the center of the rectangle through its top right corner is at 45 degrees, even if the rectangle is not square; a line through the bottom right corner is at 135 degrees, and so on (see Figure E-20).

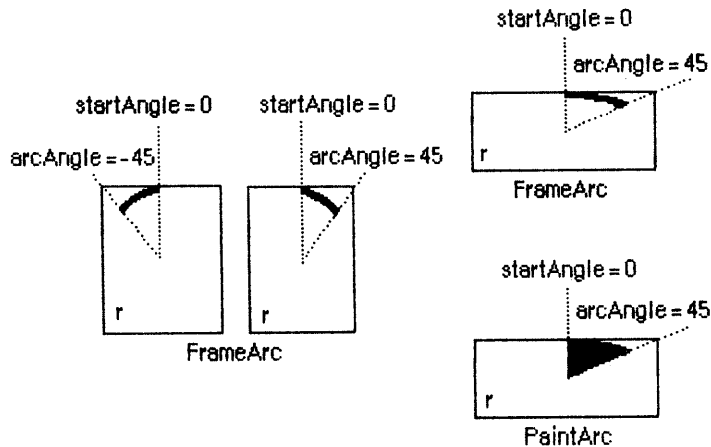

**Figure E-20**  
Operations on Arcs and Wedges

The arc is as wide as the pen width and as tall as the pen height. It is drawn with the `pnPat`, according to the pattern transfer mode specified by `pnMode`. The pen location is not changed by this procedure.

---

**WARNING**

---

`FrameArc` differs from other QuickDraw procedures that frame shapes in that the arc is not mathematically added to the boundary of a region that is open and being formed.

---

**Procedure PaintArc (r: Rect; startAngle, arcAngle: integer);**

`PaintArc` paints a wedge of the oval just inside the specified rectangle with the current `grafPort`'s pen pattern and mode. `StartAngle` and `arcAngle` define the arc of the wedge as in `FrameArc`. The wedge on the bitmap is filled with the `pnPat`, according to the pattern transfer mode specified by `pnMode`. The pen location is not changed by this procedure.

**Procedure EraseArc (r: Rect; startAngle, arcAngle: integer);**

`EraseArc` paints a wedge of the oval just inside the specified rectangle with the current `grafPort`'s background pattern `bkPat` (in `patCopy` mode). `StartAngle` and `arcAngle` define the arc of the wedge as in `FrameArc`. The `grafPort`'s `pnPat` and `pnMode` are ignored; the pen location is not changed.

**Procedure InvertArc (r: Rect; startAngle, arcAngle: integer);**

`InvertArc` inverts the pixels enclosed by a wedge of the oval just inside the specified rectangle: every white pixel becomes black and every black pixel becomes white. `StartAngle` and `arcAngle` define the arc of the wedge as in `FrameArc`. The `grafPort`'s `pnPat`, `pnMode`, and `bkPat` are all ignored; the pen location is not changed.

**Procedure FillArc (r: Rect; startAngle, arcAngle: integer; pat:  
Pattern);**

`FillArc` fills a wedge of the oval just inside the specified rectangle with the given pattern (in `patCopy` mode). `StartAngle` and `arcAngle` define the arc of the wedge as in `FrameArc`. The `grafPort`'s `pnPat`, `pnMode`, and `bkPat` are all ignored; the pen location is not changed.

## E.9.11 Calculations with Regions

---

**NOTE**

---

Remember that if the parameters to one of the calculation routines were defined in different grafPorts, you must first adjust them to be in the same coordinate system. If you do not adjust them, the result returned by the routine may be different from what you see on the screen. To adjust to a common coordinate system, see LocalToGlobal and GlobalToLocal in Section E.9.17, Calculations with Points.

---

**Function NewRgn : RgnHandle;**

NewRgn allocates space for a new, dynamic, variable-size region, initializes it to the empty region (0,0,0,0), and returns a handle to the new region. Only this function creates new regions; all other procedures just alter the size and shape of regions you create. OpenPort calls NewRgn to allocate space for the port's visRgn and clipRgn.

---

**WARNINGS**

---

Except when using visRgn or clipRgn, you *must* call NewRgn before specifying a region's handle in any drawing or calculation procedure. Never refer to a region without using its handle.

---

**Procedure DisposeRgn (rgn: RgnHandle);**

DisposeRgn deallocates space for the region whose handle is supplied, and returns the memory used by the region to the free memory pool. Use this only after you are completely through with a temporary region.

---

**WARNING**

---

Never use a region once you have deallocated it, or you will risk being hung by dangling pointers!

---

**Procedure CopyRgn (srcRgn, dstRgn: RgnHandle);**

CopyRgn copies the mathematical structure of srcRgn into dstRgn; that is, it makes a duplicate copy of srcRgn. Once this is done, srcRgn may be altered (or even disposed of) without affecting dstRgn. *CopyRgn does not create the destination region:* you must use NewRgn to create the dstRgn before you call CopyRgn.

**Procedure SetEmptyRgn (rgn: RgnHandle);**

SetEmptyRgn destroys the previous structure of the given region, then sets the new structure to the empty region (0,0,0,0).

**Procedure SetRectRgn (rgn: RgnHandle; left, top, right, bottom: integer);**

SetRectRgn destroys the previous structure of the given region, then sets the new structure to the rectangle specified by **left**, **top**, **right**, and **bottom**.

If the specified rectangle is empty (i.e., **left**>**right** or **top**>**bottom**), the region is set to the empty region (0,0,0,0).

**Procedure RectRgn (rgn: RgnHandle; r: Rect);**

RectRgn destroys the previous structure of the given region, then sets the new structure to the rectangle specified by **r**. This is operationally synonymous with SetRectRgn, except the input rectangle is defined by a rectangle rather than by four boundary coordinates.

**Procedure OpenRgn;**

OpenRgn tells QuickDraw to allocate temporary space and start saving lines and framed shapes for later processing as a region definition. While a region is open, all calls to Line, LineTo, and the procedures that draw framed shapes (except arcs) affect the outline of the region. Only the line endpoints and shape boundaries affect the region definition; the pen mode, pattern, and size do not affect it. In fact, OpenRgn calls HidePen, so no drawing occurs on the screen while the region is open (unless you called ShowPen just after OpenRgn, or you called ShowPen previously without balancing it by a call to HidePen). Since the pen hangs below and to the right of the pen location, drawing lines with even the smallest pen will change bits that lie outside the region you define.

The outline of a region is mathematically defined and infinitely thin, and separates the bitmap into two groups of bits: those within the region and those outside it. A region should consist of one or more closed loops. Each framed shape itself constitutes a loop. Any lines drawn with Line or LineTo should connect with each other or with a framed shape. Even though the on-screen presentation of a region is clipped, the definition of a region is not; you can define a region anywhere on the coordinate plane with complete disregard for the location of various grafPort entities on that plane.

When a region is open, the current grafPort's **rgnSave** field contains a handle to information related to the region definition. If you want to temporarily disable the collection of lines and shapes, you can save the current value of

this field, set the field to `nil`, and later restore the saved value to resume the region definition.

---

**WARNING**

---

Do not call `OpenRgn` while another region is already open. All open regions but the most recent will behave strangely.

---

**Procedure CloseRgn (dstRgn: RgnHandle);**

`CloseRgn` stops the collection of lines and framed shapes, organizes them into a region definition, and saves the resulting region into the region indicated by `dstRgn`. You should perform one and only one `CloseRgn` for every `OpenRgn`. `CloseRgn` calls `ShowPen`, balancing the `HidePen` call made by `OpenRgn`.

Here's an example of how to create and open a region, define a barbell shape, close the region, and draw it:

```

barbell := NewRgn;           {make a new region}
OpenRgn;                    {begin collecting stuff}
  SetRect(tempRect, 20, 20, 30, 50); {form the left weight}
  FrameOval(tempRect);
  SetRect(tempRect, 30, 30, 80, 40); {form the bar}
  FrameRect(tempRect);
  SetRect(tempRect, 80, 20, 90, 50); {form the right weight}
  FrameOval(tempRect);
CloseRgn(barbell);          {we're done; save in barbell}
FillRgn(barbell, black);    {draw it on the screen}
DisposeRgn(barbell);        {we don't need you anymore...}

```

**Procedure OffsetRgn (rgn: RgnHandle; dh, dv: integer);**

`OffsetRgn` moves the region on the coordinate plane, a distance of `dh` horizontally and `dv` vertically. This does not affect the screen unless you subsequently call a routine to draw the region. If `dh` and `dv` are positive, the movement is to the right and down; if either is negative, the corresponding movement is in the opposite direction. The region retains its size and shape.

---

**NOTE**

---

`OffsetRgn` is an especially efficient operation, because most of the data defining a region is stored relative to `rgnBBox` and so isn't actually changed by `OffsetRgn`.

---



**Procedure InsetRgn (rgn: RgnHandle; dh,dv: Integer);**

InsetRgn shrinks or expands the region. All points on the region boundary are moved inwards a distance of **dv** vertically and **dh** horizontally; if **dh** or **dv** is negative, the points are moved outwards in that direction. InsetRgn leaves the region "centered" at the same position, but moves the outline in (for positive values of **dh** and **dv**) or out (for negative values of **dh** and **dv**). InsetRgn of a rectangular region works just like InsetRect.

**Procedure SectRgn (srcRgnA, srcRgnB, dstRgn: RgnHandle);**

SectRgn calculates the intersection of two regions and places the intersection in a third region. *This does not create the destination region:* you must use NewRgn to create **dstRgn** before you call SectRgn. The **dstRgn** can be one of the source regions, if desired.

If the regions do not intersect, or one of the regions is empty, the destination is set to the empty region (0,0,0,0).

**Procedure UnionRgn (srcRgnA, srcRgnB, dstRgn: RgnHandle);**

UnionRgn calculates the union of two regions and places the union in a third region. *This does not create the destination region:* you must use NewRgn to create **dstRgn** before you call UnionRgn. The **dstRgn** can be one of the source regions, if desired.

If both regions are empty, the destination is set to the empty region (0,0,0,0).

**Procedure DiffRgn (srcRgnA, srcRgnB, dstRgn: RgnHandle);**

DiffRgn subtracts **srcRgnB** from **srcRgnA** and places the difference in a third region. *This does not create the destination region:* you must use NewRgn to create **dstRgn** before you call DiffRgn. The **dstRgn** can be one of the source regions, if desired.

If the first source region is empty, the destination is set to the empty region (0,0,0,0).

**Procedure XorRgn (srcRgnA, srcRgnB, dstRgn: RgnHandle);**

XorRgn calculates the difference between the union and the intersection of two regions and places the result in a third region. *This does not create the destination region:* you must use NewRgn to create **dstRgn** before you call XorRgn. The **dstRgn** can be one of the source regions, if desired.

If the regions are coincident, the destination is set to the empty region (0,0,0,0).

**Function PtInRgn (pt: Point; rgn: RgnHandle) : boolean;**

PtInRgn checks whether the pixel below and to the right of the given coordinate point is within the specified region, and returns **true** if so or **false** if not.

**Function RectInRgn (r: Rect; rgn: RgnHandle) : boolean;**

RectInRgn checks whether the given rectangle intersects the specified region, and returns **true** if the intersection encloses at least one bit or **false** if not.

**Function EqualRgn (rgnA, rgnB: RgnHandle) : boolean;**

EqualRgn compares the two regions and returns **true** if they are equal or **false** if not. The two regions must have identical sizes, shapes, and locations to be considered equal. Any two empty regions are always equal.

**Function EmptyRgn (rgn: RgnHandle) : boolean;**

EmptyRgn returns **true** if the region is an empty region or **false** if not. Some of the circumstances in which an empty region can be created are: a NewRgn call; a CopyRgn of an empty region; a SetRectRgn or RectRgn with an empty rectangle as an argument; CloseRgn without a previous OpenRgn or with no drawing after an OpenRgn; OffsetRgn of an empty region; InsetRgn with an empty region or too large an Inset; SectRgn of nonintersecting regions; UnionRgn of two empty regions; and DiffRgn or XorRgn of two identical or nonintersecting regions.

#### **E.9.12 Graphic Operations on Regions**

These routines all depend on the coordinate system of the current grafPort. If a region is drawn in a different grafPort than the one in which it was defined, it may not appear in the proper position inside the port.

**Procedure FrameRgn (rgn: RgnHandle);**

FrameRgn draws a hollow outline just inside the specified region, using the current grafPort's pen pattern, mode, and size. The outline is as wide as the pen width and as tall as the pen height; under no circumstances will the frame go outside the region boundary. The pen location is not changed by this procedure.

If a region is open and being formed, the outside outline of the region being framed is mathematically added to that region's boundary.

**Procedure PaintRgn (rgn: RgnHandle);**

PaintRgn paints the specified region with the current grafPort's pen pattern and pen mode. The region on the bitmap is filled with the **pnPat**, according

to the pattern transfer mode specified by **pnMode**. The pen location is not changed by this procedure.

**Procedure EraseRgn (rgn: RgnHandle);**

EraseRgn paints the specified region with the current grafPort's background pattern **bkPat** (in **patCopy** mode). The grafPort's **pnPat** and **pnMode** are ignored; the pen location is not changed.

**Procedure InvertRgn (rgn: RgnHandle);**

InvertRgn inverts the pixels enclosed by the specified region: every white pixel becomes black and every black pixel becomes white. The grafPort's **pnPat**, **pnMode**, and **bkPat** are all ignored; the pen location is not changed.

**Procedure FillRgn (rgn: RgnHandle; pat: Pattern);**

FillRgn fills the specified region with the given pattern (in **patCopy** mode). The grafPort's **pnPat**, **pnMode**, and **bkPat** are all ignored; the pen location is not changed.

### E.9.13 Bit Transfer Operations

**Procedure ScrollRect (r: Rect; dh,dv: Integer; updateRgn: RgnHandle);**

ScrollRect shifts ("scrolls") those bits inside the intersection of the specified rectangle, **visRgn**, **clipRgn**, **portRect**, and **portBits.bounds**. The bits are shifted a distance of **dh** horizontally and **dv** vertically. The positive directions are to the right and down. No other bits are affected. Bits that are shifted out of the scroll area are lost; they are neither placed outside the area nor saved. The grafPort's background pattern **bkPat** fills the space created by the scroll. In addition, **updateRgn** is changed to the area filled with **bkPat** (see Figure E-21).

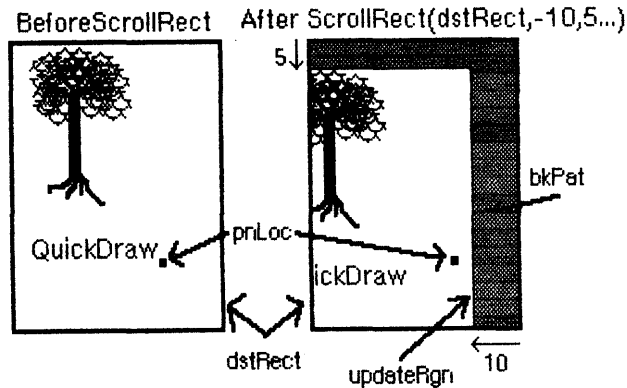

Figure E-21  
Scrolling

Figure E-21 shows that the pen location after a ScrollRect is in a different position relative to what was scrolled in the rectangle. The entire scrolled item has been moved to different coordinates. To restore it to its coordinates before the ScrollRect, you can use the SetOrigin procedure. For example, suppose the `dstRect` here is the `portRect` of the `grafPort` and its top left corner is at (95,120). `SetOrigin(105,115)` will offset the coordinate system to compensate for the scroll. Since the `clipRgn` and pen location are not offset, they move down and to the left.

**Procedure CopyBits (srcBits, dstBits: BitMap; srcRect, dstRect: Rect; mode: integer; maskRgn: RgnHandle);**

CopyBits transfers a bit image between any two bitmaps and clips the result to the area specified by the `maskRgn` parameter. The transfer may be performed in any of the eight source transfer modes. The result is always clipped to the `maskRgn` and the boundary rectangle of the destination bitmap; if the destination bitmap is the current `grafPort`'s `portBits`, it is also clipped to the intersection of the `grafPort`'s `clipRgn` and `visRgn`. If you do not want to clip to a `maskRgn`, just pass nil for the `maskRgn` parameter.

The `dstRect` and `maskRgn` coordinates are in terms of the `dstBits.bounds` coordinate system, and the `srcRect` coordinates are in terms of the `srcBits.bounds` coordinates.

The bits enclosed by the source rectangle are transferred into the destination rectangle according to the rules of the chosen mode.

The source transfer modes are as follows:

<code>srcCopy</code>	<code>srcXor</code>	<code>notSrcCopy</code>	<code>notSrcXor</code>
<code>srcOr</code>	<code>srcBic</code>	<code>notSrcOr</code>	<code>notSrcBic</code>

The source rectangle is completely aligned with the destination rectangle; if the rectangles are of different sizes, the bit image is expanded or shrunk as necessary to fit the destination rectangle. For example, if the bit image is a circle in a square source rectangle, and the destination rectangle is not square, the bit image appears as an oval in the destination (see Figure E-22).

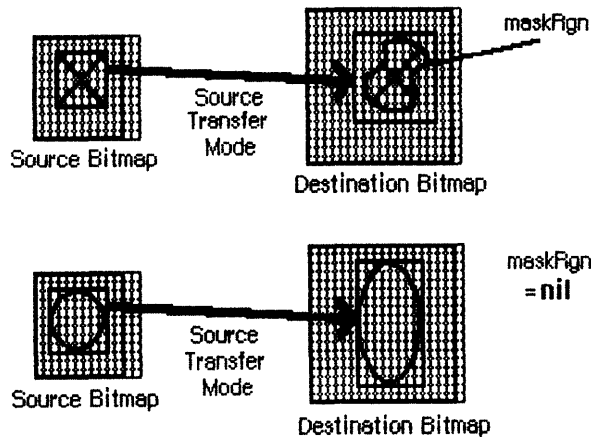

Figure E-22  
Operation of CopyBits

#### E.9.14 Pictures

**Function** `OpenPicture (picFrame: Rect) : PicHandle;`

`OpenPicture` returns a handle to a new picture which has the given rectangle as its picture frame, and tells QuickDraw to start saving as the picture definition all calls to drawing routines and all picture comments (if any).

`OpenPicture` calls `HidePen`, so no drawing occurs on the screen while the picture is open (unless you call `ShowPen` just after `OpenPicture`, or you called `ShowPen` previously without balancing it by a call to `HidePen`).

When a picture is open, the current `grafPort`'s `picSave` field contains a handle to information related to the picture definition. If you want to temporarily

disable the collection of routine calls and picture comments, you can save the current value of this field, set the field to nil, and later restore the saved value to resume the picture definition.

---

**WARNING**

---

Do not call `OpenPicture` while another picture is already open.

---

**Procedure ClosePicture;**

`ClosePicture` tells QuickDraw to stop saving routine calls and picture comments as the definition of the currently open picture. You should perform one and only one `ClosePicture` for every `OpenPicture`. `ClosePicture` calls `ShowPen`, balancing the `HidePen` call made by `OpenPicture`.

**Procedure PicComment (kind, dataSize: integer; dataHandle: QDHandle);**

`PicComment` inserts the specified comment into the definition of the currently open picture. `Kind` identifies the type of comment. `DataHandle` is a handle to additional data if desired, and `dataSize` is the size of that data in bytes. If there is no additional data for the comment, `dataHandle` should be nil and `dataSize` should be 0. The application that processes the comment must include a procedure to do the processing and store a pointer to the procedure in the data structure pointed to by the `grafProcs` field of the `grafPort` (see Section E.10, Customizing QuickDraw Operations).

**Procedure DrawPicture (myPicture: PicHandle; dstRect: Rect);**

`DrawPicture` draws the given picture to scale in `dstRect`, expanding or shrinking it as necessary to align the borders of the picture frame with `dstRect`. `DrawPicture` passes any picture comments to the procedure accessed indirectly through the `grafProcs` field of the `grafPort` (see `PicComment` above).

**Procedure KillPicture (myPicture: PicHandle);**

`KillPicture` deallocates space for the picture whose handle is supplied, and returns the memory used by the picture to the free memory pool. Use this only when you are completely through with a picture.

### E.9.15 Calculations with Polygons

**Function OpenPoly : PolyHandle;**

`OpenPoly` returns a handle to a new polygon and tells QuickDraw to start saving the polygon definition as specified by calls to line-drawing routines. While a polygon is open, all calls to `Line` and `LineTo` affect the outline of the polygon. Only the line endpoints affect the polygon definition; the pen mode, pattern, and size do not affect it. In fact, `OpenPoly` calls `HidePen`, so no

drawing occurs on the screen while the polygon is open (unless you call ShowPen just after OpenPoly, or you called ShowPen previously without balancing it by a call to HidePen).

A polygon should consist of a sequence of connected lines. Even though the on-screen presentation of a polygon is clipped, the definition of a polygon is not; you can define a polygon anywhere on the coordinate plane with complete disregard for the location of various grafPort entities on that plane.

When a polygon is open, the current grafPort's **polySave** field contains a handle to information related to the polygon definition. If you want to temporarily disable the polygon definition, you can save the current value of this field, set the field to nil, and later restore the saved value to resume the polygon definition.

---

#### WARNING

---

Do not call OpenPoly while another polygon is already open.

---

#### Procedure ClosePoly;

ClosePoly tells QuickDraw to stop saving the definition of the currently open polygon and computes the **polyBBox** rectangle. You should perform one and only one ClosePoly for every OpenPoly. ClosePoly calls ShowPen, balancing the HidePen call made by OpenPoly.

Here's an example of how to open a polygon, define it as a triangle, close it, and draw it:

```

triPoly := OpenPoly;    {save handle and begin collecting stuff}
  MoveTo(300,100);      { move to first point and }
  LineTo(400,200);      {           form           }
  LineTo(200,200);      {           the           }
  LineTo(300,100);      {           triangle        }
ClosePoly;              { stop collecting stuff    }
FillPoly(triPoly,gray); { draw it on the screen   }
KillPoly(triPoly);      { we're all done         }

```

#### Procedure KillPoly (poly: PolyHandle);

KillPoly deallocates space for the polygon whose handle is supplied, and returns the memory used by the polygon to the free memory pool. Use this only after you are completely through with a polygon.

#### Procedure OffsetPoly (poly: PolyHandle; dh, dv: integer);

OffsetPoly moves the specified polygon on the coordinate plane, a distance of **dh** horizontally and **dv** vertically. This does not affect the screen unless you

subsequently call a routine to draw the polygon. If `dx` and `dy` are positive, the movement is to the right and down; if either is negative, the corresponding movement is in the opposite direction. The polygon retains its shape and size.

---

**NOTE**

---

`OffsetPoly` is an especially efficient operation, because the data defining a polygon is stored relative to `polyStart` and so isn't actually changed by `OffsetPoly`.

---

### E.9.16 Graphic Operations on Polygons

#### Procedure `FramePoly` (`poly: PolyHandle`);

`FramePoly` plays back the line-drawing routine calls that define the given polygon, using the current `grafPort`'s pen pattern, mode, and size. The pen will hang below and to the right of each point on the boundary of the polygon; thus, the polygon drawn will extend beyond the right and bottom edges of `poly^.polyBBox` by the pen width and pen height, respectively. All other graphic operations occur strictly within the boundary of the polygon, as for other shapes. You can see this difference in Figure E-23, where each of the polygons is shown with its `polyBBox`.

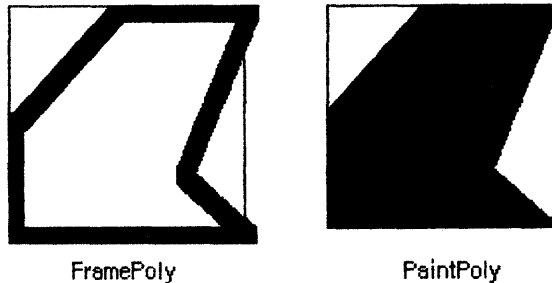

**Figure E-23**  
**Drawing Polygons**

If a polygon is open and being formed, `FramePoly` affects the outline of the polygon just as if the line-drawing routines themselves had been called. If a region is open and being formed, the outside outline of the polygon being framed is mathematically added to the region's boundary.



**Procedure PaintPoly (poly: PolyHandle);**

PaintPoly paints the specified polygon with the current grafPort's pen pattern and pen mode. The polygon on the bitmap is filled with the **pnPat**, according to the pattern transfer mode specified by **pnMode**. The pen location is not changed by this procedure.

**Procedure ErasePoly (poly: PolyHandle);**

ErasePoly paints the specified polygon with the current grafPort's background pattern **bkPat** (in **patCopy** mode). The **pnPat** and **pnMode** are ignored; the pen location is not changed.

**Procedure InvertPoly (poly: PolyHandle);**

InvertPoly inverts the pixels enclosed by the specified polygon: every white pixel becomes black and every black pixel becomes white. The grafPort's **pnPat**, **pnMode**, and **bkPat** are all ignored; the pen location is not changed.

**Procedure FillPoly (poly: PolyHandle; pat: Pattern);**

FillPoly fills the specified polygon with the given pattern (in **patCopy** mode). The grafPort's **pnPat**, **pnMode**, and **bkPat** are all ignored; the pen location is not changed.

**E.9.17 Calculations with Points****Procedure AddPt (srcPt: Point; var dstPt: Point);**

AddPt adds the coordinates of **srcPt** to the coordinates of **dstPt**, and returns the result in **dstPt**.

**Procedure SubPt (srcPt: Point; var dstPt: Point);**

SubPt subtracts the coordinates of **srcPt** from the coordinates of **dstPt**, and returns the result in **dstPt**.

**Procedure SetPt (var pt: Point; h,v: integer);**

SetPt assigns two integer coordinates to a variable of type **Point**.

**Function EqualPt (ptA,ptB: Point) : boolean;**

EqualPt compares the two points and returns **true** if they are equal or **false** if not.

**Procedure LocalToGlobal (var pt: Point);**

LocalToGlobal converts the given point from the current grafPort's local coordinate system into a global coordinate system with the origin (0,0) at the top left corner of the port's bit image (such as the screen). This global point can then be compared to other global points, or be changed into the local coordinates of another grafPort.

Since a rectangle is defined by two points, you can convert a rectangle into global coordinates by performing two LocalToGlobal calls. You can also convert a rectangle, region, or polygon into global coordinates by calling OffsetRect, OffsetRgn, or OffsetPoly. For examples, see GlobalToLocal below.

**Procedure GlobalToLocal (var pt: Point);**

GlobalToLocal takes a point expressed in global coordinates (with the top left corner of the bitmap as coordinate (0,0)) and converts it into the local coordinates of the current grafPort. The global point can be obtained with the LocalToGlobal call (see above). For example, suppose a game draws a "ball" within a rectangle named ballRect, defined in the grafPort named gamePort (as illustrated below in Figure E-24). If you want to draw that ball in the grafPort named selectPort, you can calculate the ball's selectPort coordinates like this:

```

SetPort(gamePort);           { start in origin port }
selectBall := ballRect;     { make a copy to be moved }
LocalToGlobal(selectBall.topLeft); { put both corners into }
LocalToGlobal(selectBall.botRight); { global coordinates }

SetPort(selectPort);        { switch to destination port }
GlobalToLocal(selectBall.topLeft); { put both corners into }
GlobalToLocal(selectBall.botRight); { these local coordinates }
FillOval(selectBall, ballColor); { now you have the ball! }

```

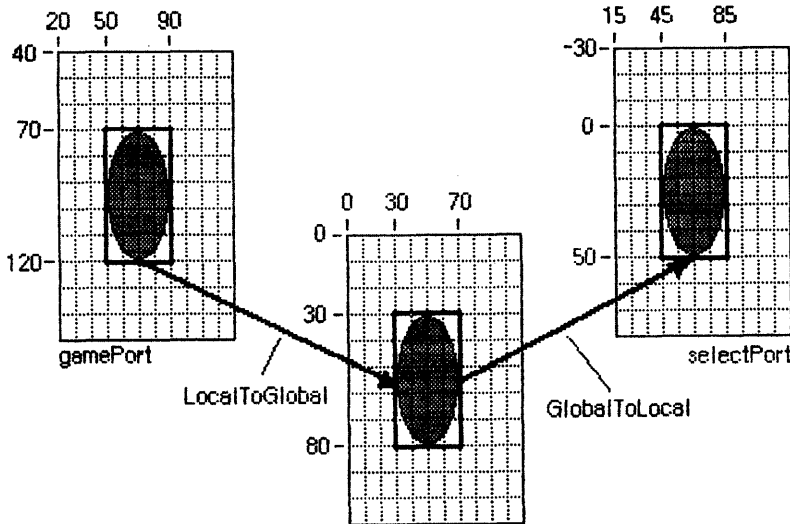

**Figure E-24**  
**Converting between Coordinate Systems**

You can see from Figure E-24 that `LocalToGlobal` and `GlobalToLocal` simply offset the coordinates of the rectangle by the coordinates of the top left corner of the local `grafPort`'s boundary rectangle. You could also do this with `OffsetRect`. In fact, the way to convert regions and polygons from one coordinate system to another is with `OffsetRgn` or `OffsetPoly` rather than `LocalToGlobal` and `GlobalToLocal`. For example, if `myRgn` were a region enclosed by a rectangle having the same coordinates as `ballRect` in `gamePort`, you could convert the region to global coordinates with

```
OffsetRgn(myRgn, -20, -40);
```

and then convert it to the coordinates of the `selectPort` `grafPort` with

```
OffsetRgn(myRgn, 15, -30);
```

#### E.9.18 Miscellaneous Utilities

**Function** `Random` : integer;

`Random` returns an integer, uniformly distributed pseudo-random, in the range from -32768 through 32767. The value returned depends on the global variable `randSeed`, which `InitGraf` initializes to 1; you can start the sequence over again from where it began by resetting `randSeed` to 1.

**Function GetPixel (h,v: integer) : boolean;**

GetPixel looks at the pixel associated with the given coordinate point and returns **true** if it is black or **false** if it is white. The selected pixel is immediately below and to the right of the point whose coordinates are given in **h** and **v**, in the local coordinates of the current grafPort. There is no guarantee that the specified pixel actually belongs to the port, however; it may have been drawn by a port overlapping the current one. To see if the point indeed belongs to the current port, call **PtInRgn(pt,thePort^.visRgn)**.

**Procedure StuffHex (thingPtr: QDPtr; s: Str255);**

StuffHex pokes bits (expressed as a string of hexadecimal digits) into any data structure. This is a good way to create cursors, patterns, or bit images to be "stamped" onto the screen with CopyBits. For example,

```
StuffHex(@stripes, '0102040810204080')
```

places a striped pattern into the pattern variable stripes.

---

**WARNING**

---

There is no range checking on the size of the destination variable. It's easy to overrun the variable and destroy something if you don't know what you're doing.

---

**Procedure ScalePt (var pt: Point; srcRect,dstRect: Rect);**

A width and height are passed in **pt**; the horizontal component of **pt** is the width, and the vertical component of **pt** is the height. ScalePt scales these measurements as follows and returns the result in **pt**: It multiplies the given width by the ratio of **dstRect**'s width to **srcRect**'s width, and multiplies the given height by the ratio of **dstRect**'s height to **srcRect**'s height. In Figure E-25, where **dstRect**'s width is twice **srcRect**'s width and its height is three times **srcRect**'s height, the pen width is scaled from 3 to 6 and the pen height is scaled from 2 to 6.

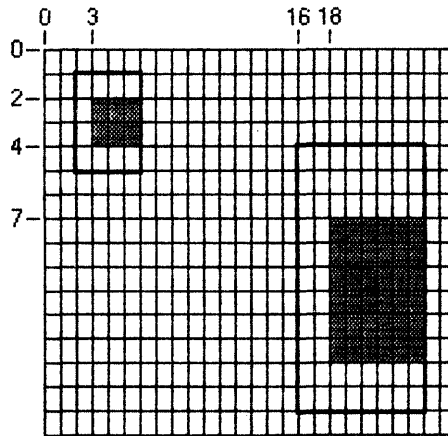

ScalePt scales pen size (3,2) to (6,6)  
MapPt maps point (3,2) to (18,7)

Figure E-25  
ScalePt and MapPt

**Procedure MapPt (var pt: Point; srcRect, dstRect: Rect);**

Given a point within **srcRect**, **MapPt** maps it to a similarly located point within **dstRect** (that is, to where it would fall if it were part of a drawing being expanded or shrunk to fit **dstRect**). The result is returned in **pt**. A corner point of **srcRect** would be mapped to the corresponding corner point of **dstRect**, and the center of **srcRect** to the center of **dstRect**. In Figure E-25 above, the point (3,2) in **srcRect** is mapped to (18,7) in **dstRect**. **FromRect** and **dstRect** may overlap, and **pt** need not actually be within **srcRect**.

---

**WARNING**

---

Remember, if you are going to draw inside the rectangle in `dstRect`, you will probably also want to scale the pen size accordingly with `ScalePt`.

---

**Procedure MapRect (var r: Rect; srcRect, dstRect: Rect);**

Given a rectangle within `srcRect`, `MapRect` maps it to a similarly located rectangle within `dstRect` by calling `MapPt` to map the top left and bottom right corners of the rectangle. The result is returned in `r`.

**Procedure MapRgn (rgn: RgnHandle; srcRect, dstRect: Rect);**

Given a region within `srcRect`, `MapRgn` maps it to a similarly located region within `dstRect` by calling `MapPt` to map all the points in the region.

**Procedure MapPoly (poly: PolyHandle; srcRect, dstRect: Rect);**

Given a polygon within `srcRect`, `MapPoly` maps it to a similarly located polygon within `dstRect` by calling `MapPt` to map all the points that define the polygon.

#### E.10 Customizing QuickDraw Operations

For each shape that QuickDraw knows how to draw, there are procedures that perform these basic graphic operations on the shape: frame, paint, erase, invert, and fill. Those procedures in turn call a low-level drawing routine for the shape. For example, the `FrameOval`, `PaintOval`, `EraseOval`, `InvertOval`, and `FillOval` procedures all call a low-level routine that draws the oval. For each type of object QuickDraw can draw, including text and lines, there is a pointer to such a routine. By changing these pointers, you can install your own routines, and either completely override the standard ones or call them after your routines have modified parameters as necessary.

Other low-level routines that you can install in this way are:

- The procedure that does bit transfer and is called by `CopyBits`.
- The function that measures the width of text and is called by `CharWidth`, `StringWidth`, and `TextWidth`.
- The procedure that processes picture comments and is called by `DrawPicture`. The standard such procedure ignores picture comments.
- The procedure that saves drawing commands as the definition of a picture, and the one that retrieves them. This enables the application to draw on remote devices, print to the disk, get picture input from the disk, and support large pictures.

The `grafProcs` field of a `grafPort` determines which low-level routines are called; if it contains `nil`, the standard routines are called, so that all operations in that `grafPort` are done in the standard ways described in this appendix. You can set the `grafProcs` field to point to a record of pointers to routines. The data type of `grafProcs` is `QDProcsPtr`:

```

type QDProcsPtr = ^QDProcs;
QDProcs      = record
    textProc:   QDPtr; {text drawing}
    lineProc:   QDPtr; {line drawing}
    rectProc:   QDPtr; {rectangle drawing}
    rRectProc:  QDPtr; {roundRect drawing}
    ovalProc:   QDPtr; {oval drawing}
    arcProc:    QDPtr; {arc/wedge drawing}
    polyProc:   QDPtr; {polygon drawing}
    rgnProc:    QDPtr; {region drawing}
    bitsProc:   QDPtr; {bit transfer}
    commentProc: QDPtr; {picture comment
                        processing}
    txMeasProc: QDPtr; {text width measurement}
    getPicProc: QDPtr; {picture retrieval}
    putPicProc: QDPtr; {picture saving}
end;

```

#### Procedure SetStdProcs (var procs: QDProcs);

`SetStdProcs` is provided to assist you in setting up a `QDProcs` record. It sets all the fields of the given `QDProcs` to point to the standard low-level routines. You can then change the ones you wish to point to your own routines. For example, if your procedure that processes picture comments is named `MyComments`, you will store `@MyComments` in the `commentProc` field of the `QDProcs` record.

The routines you install must of course have the same calling sequences as the standard routines, which are described below. The standard drawing routines tell which graphic operation to perform from a parameter of type `GrafVerb`.

```

type GrafVerb = (frame, paint, erase, invert, fill);

```

When the `grafVerb` is `fill`, the pattern to use when filling is passed in the `fillPat` field of the `grafPort`.

#### Procedure StdText (byteCount: integer; textBuf: QDPtr; numer, denom: Point);

`StdText` is the standard low-level routine for drawing text. It draws text from the arbitrary structure in memory specified by `textBuf`, starting from the first byte and continuing for `byteCount` bytes. `Numer` and `denom` specify the

scaling, if any: **numer.v** over **denom.v** gives the vertical scaling, and **numer.h** over **denom.h** gives the horizontal scaling.

**Procedure StdLine (newPt: Point);**

**StdLine** is the standard low-level routine for drawing a line. It draws a line from the current pen location to the location specified (in local coordinates) by **newPt**.

**Procedure StdRect (verb: GrafVerb; r: Rect);**

**StdRect** is the standard low-level routine for drawing a rectangle. It draws the given rectangle according to the specified **grafVerb**.

**Procedure StdRRect (verb: GrafVerb; r: Rect; ovalWidth, ovalHeight: integer);**

**StdRRect** is the standard low-level routine for drawing a rounded-corner rectangle. It draws the given rounded-corner rectangle according to the specified **grafVerb**. **OvalWidth** and **ovalHeight** specify the diameters of curvature for the corners.

**Procedure StdOval (verb: GrafVerb; r: Rect);**

**StdOval** is the standard low-level routine for drawing an oval. It draws an oval inside the given rectangle according to the specified **grafVerb**.

**Procedure StdArc (verb: GrafVerb; r: Rect; startAngle, arcAngle: integer);**

**StdArc** is the standard low-level routine for drawing an arc or a wedge. It draws an arc or wedge of the oval that fits inside the given rectangle. The **grafVerb** specifies the graphic operation; if it's the frame operation, an arc is drawn; otherwise, a wedge is drawn.

**Procedure StdPoly (verb: GrafVerb; poly: PolyHandle);**

**StdPoly** is the standard low-level routine for drawing a polygon. It draws the given polygon according to the specified **grafVerb**.

**Procedure StdRgn (verb: GrafVerb; rgn: RgnHandle);**

**StdRgn** is the standard low-level routine for drawing a region. It draws the given region according to the specified **grafVerb**.



**Procedure StdBits (var srcBits: BitMap; var srcRect, dstRect: Rect;  
mode: integer; maskRgn: RgnHandle);**

StdBits is the standard low-level routine for doing bit transfer. It transfers a bit image between the given bitmap and thePort^.portBits, just as if CopyBits were called with the same parameters and with a destination bitmap equal to thePort^.portBits.

**Procedure StdComment (kind, dataSize: integer; dataHandle: QDHandle);**

StdComment is the standard low-level routine for processing a picture comment. Kind identifies the type of comment. DataHandle is a handle to additional data, and dataSize is the size of that data in bytes. If there is no additional data for the command, dataHandle will be nil and dataSize will be 0. StdComment simply ignores the comment.

**Function StdTxMeas (byteCount: integer; textBuf: QDPtr; var numer,  
denom: Point; var info: FontInfo) : integer;**

StdTxMeas is the standard low-level routine for measuring text width. It returns the width of the text stored in the arbitrary structure in memory specified by textBuf, starting with the first byte and continuing for byteCount bytes. Numer and denom specify the scaling as in the StdText procedure; note that StdTxMeas may change them.

**Procedure StdGetPic (dataPtr: QDPtr; byteCount: integer);**

StdGetPic is the standard low-level routine for retrieving information from the definition of a picture. It retrieves the next byteCount bytes from the definition of the currently open picture and stores them in the data structure pointed to by dataPtr.

**Procedure StdPutPic (dataPtr: QDPtr; byteCount: integer);**

StdPutPic is the standard low-level routine for saving information as the definition of a picture. It saves as the definition of the currently open picture the drawing commands stored in the data structure pointed to by dataPtr, starting with the first byte and continuing for the next byteCount bytes.

## E.11 Using QuickDraw from Assembly Language

All QuickDraw routines can be called from assembly-language programs as well as from Pascal. When you write an assembly-language program to use these routines, though, you must emulate Pascal's parameter passing and variable transfer protocols.

This section discusses how to use the QuickDraw constants, global variables, data types, procedures, and functions from assembly language.

The primary aid to assembly language programmers is a file named **QD/GRAFTYPES.TEXT**. If you use **.INCLUDE** to include this file when you assemble your program, all the QuickDraw constants, offsets to locations of global variables, and offsets into the fields of structured types will be available in symbolic form.

### E.11.1 Constants

QuickDraw constants are stored in the **QD/GRAFTYPES.TEXT** file, and you can use the constant values symbolically. For example, if you've loaded the effective address of the **thePort** **txMode** field into address register A2, you can set that field to the **srcXor** mode with this statement:

```
MOVE.W #SRCXOR, (A2)
```

To refer to the number of bytes occupied by the QuickDraw global variables, you can use the constant **GRAFSIZE**. When you call the **InitGraf** procedure, you must pass a pointer to an area at least that large.

### E.11.2 Data Types

Pascal's strong typing ability lets you write Pascal programs without really considering the size of a variable. But in assembly language, you must keep track of the size of every variable. The sizes of the standard Pascal data types are as follows:

Type	Size
integer	Word (2 bytes)
longint	Long (4 bytes)
boolean	Word (2 bytes)
char	Word (2 bytes)
real	Long (4 bytes)

Integers and longints are in two's complement form; booleans have their boolean value in bit 8 of the word (the low-order bit of the byte at the same location); chars are stored in the high-order byte of the word; and reals are in the KCS standard format.

The QuickDraw simple data types listed below are constructed out of these fundamental types.

<u>Type</u>	<u>Size</u>
QDPtr	Long (4 bytes)
QDHandle	Long (4 bytes)
Word	Long (4 bytes)
Str255	Page (256 bytes)
Pattern	8 bytes
Bits16	32 bytes

Other data types are constructed as records of variables of the above types. The size of such a type is the sum of the sizes of all the fields in the record; the fields appear in the variable with the first field in the lowest address. For example, consider the data type `BitMap`, which is defined as follows:

```

type BitMap = record
    baseAddr: QDPtr;
    rowBytes: integer;
    bounds:   Rect
end;
```

This data type would be arranged in memory as seven words: a long for the `baseAddr`, a word for the `rowBytes`, and four words for the top, left, right, and bottom parts of the `bounds` rectangle. To assist you in referring to the fields inside a variable that has a structure like this, the `QD/GRAFTYPES.TEXT` file defines constants that you can use as offsets into the fields of a structured variable. For example, to move a bitmap's `rowBytes` value into `D3`, you would execute the following instruction:

```
MOVE.W MYBITMAP+ROWBYTES,D3
```

Displacements are given in the `QD/GRAFTYPES.TEXT` file for all fields of all data types defined by QuickDraw.

To do double indirection, you perform an `LEA` indirectly to obtain the effective address from the handle. For example, to get at the top coordinate of a region's enclosing rectangle:

```

MOVE.L MYHANDLE,A1           ; Load handle into A1
MOVE.L (A1),A1               ; Use handle to get pointer
MOVE.W RGNBBOX+TOP(A1),D3    ; Load value using pointer
```

---

**WARNING**

---

For regions (and all other variable-length structures with handles), you must not move the pointer into a register once and just continue to use that pointer; you must do the double indirection each time. Every QuickDraw call you make can possibly trigger a heap compaction that renders all pointers to movable heap items (like regions) invalid. The handles will remain valid, but pointers you've obtained through handles can be rendered invalid at any subroutine call or trap in your program.

---

**E.11.3 Global Variables**

Register A5 always points to the section of memory where global variables are stored. The `QD/GRAFTYPES.TEXT` file defines a constant `GRAFGLOB` that points to the beginning of the QuickDraw variables in this space, and other constants that point to the individual variables. To access one of the variables, put `GRAFGLOB` in an address register, sum the constants, and index off of that register. For example, if you want to know the horizontal coordinate of the pen location for the current `grafPort`, which the global variable `thePort` points to, you can give the following instructions:

```
MOVE.L  GRAFGLOB(A5), A0    ; Point to QuickDraw globals
MOVE.L  THEPORT(A0), A1    ; Get current grafPort
MOVE.W  PNLOC+H(A1), D0    ; Get thePort^.pnLoc.h
```

**E.11.4 Procedures and Functions**

To call a QuickDraw procedure or function, you must push all parameters to it on the stack, then `JSR` to the function or procedure. When you link your program with QuickDraw, these `JSRs` are adjusted to refer to QuickDraw's jump table, so that a `JSR` into the table redirects you to the actual location of the procedure or function.

The only difficult part about calling QuickDraw procedures and functions is stacking the parameters. You must follow some strict rules:

- Save all registers you wish to preserve *before* you begin pushing parameters. Any QuickDraw procedure or function can destroy the contents of the registers A0, A1, D0, D1, and D2, but the others are never altered.
- Push the parameters in the order that they appear in the Pascal procedural interface.
- For booleans, push a byte; for integers and characters, push a word; for pointers, handles, long integers, and reals, push a long.
- For any structured variable longer than 4 bytes, push a pointer to the variable.

- For all var parameters, regardless of size, push a pointer to the variable.
- When calling a function, *first* push a null entry equal to the size of the function result, *then* push all other parameters. The result will be left on the stack after the function returns to you.

This makes for a lengthy interface, but it also guarantees that you can mock up a Pascal version of your program, and later translate it into assembly code that works the same. For example, the Pascal statement

```
blackness := GetPixel(50, mousePos.v);
```

would be written in assembly language like this:

```
CLR.W    -(SP)           ; Save space for boolean result
MOVE.W   #50, -(SP)      ; Push constant 50 (decimal)
MOVE.W   MOUSEPOS+V, -(SP) ; Push the value of mousePos.v
JSR      GETPIXEL        ; Call routine
MOVE.W   (SP)+, BLACKNESS ; Fetch result from stack
```

This is a simple example, pushing and pulling word-long constants. Normally, you'll be pushing more pointers, using the PEA (Push Effective Address) instruction:

```
FillRoundRect(myRect, 1, thePort^.pnSize.v, white);

PEA      MYRECT           ; Push pointer to myRect
MOVE.W   #1, -(SP)        ; Push constant 1
MOVE.L   GRAFGLOB(A5), A0 ; Point to QuickDraw globals
MOVE.L   THEPORT(A0), A1  ; Get current grafPort
MOVE.W   PNSIZE+V(A1), -(SP) ; Push value of thePort^.pnSize.v
PEA      WHITE(A0)        ; Push pointer to global variable white
JSR      FILLROUNDRECT    ; Call the subroutine
```

To call the TextFace procedure, push a word in which each of seven bits represents a stylistic variation: set bit 0 for **bold**, bit 1 for *italic*, bit 2 for underline, bit 3 for **outline**, bit 4 for **shadow**, bit 5 for **condense**, and bit 6 for **extend**.

**E.12 Graf3D: Three-Dimensional Graphics**

Graf3D helps you map three-dimensional images onto the two-dimensional space used by QuickDraw. If this is your first exposure to three-dimensional graphics, you will find Graf3D's standard procedures and functions a great help in producing visually exciting graphs, charts, and drawings. If you are familiar with Applegraphics for the Apple II, you will feel right at home with Graf3D's use of real variables and world coordinates.

With three-dimensional graphics you can present objects in true perspective, which will evoke for users their everyday environment. Graf3D helps you represent complex business information pictorially; for example, a manager can see important relationships among sales, profits, and advertising dollars in a three-dimensional graph.

You may be interested in a more theoretical discussion of three-dimensional graphics, including an explanation of some of the basic concepts of Graf3D, such as the viewing pyramid. A good, illustrated discussion appears in the section on three-dimensional computer graphics in *Principles of Interactive Computer Graphics* by William M. Newman and Robert F. Sproull (New York: McGraw-Hill, 1973).

**E.12.1 How Graf3D Is Related to QuickDraw**

Graf3D is a Pascal unit that makes the QuickDraw calls necessary to produce three-dimensional graphics. It provides you with an easy-to-use real number interface to QuickDraw's integer coordinates. You could, of course, write your own QuickDraw calls to perform the same functions Graf3D provides for you, but that would be a little like going to the trouble of writing your own compiler.

**E.12.2 Features of Graf3D**

- *A camera-eye view.* This allows you to set the point of view from which the observer sees the object independently from the coordinates of the object itself. The camera is set up with the ViewPort, LookAt, and ViewAngle procedures. You can set the focal length of the camera as if you had a choice of telephoto, wide angle, or normal lenses.
- *Three-dimensional clipping to a true pyramid.* The apex of the pyramid is at the point of the camera eye, and the base of the pyramid is equivalent to the ViewPort. When you use the Clip3D function, only objects forward of the camera eye and within the pyramid are displayed on the screen.
- *Two-dimensional point and line capability using real coordinates.* Graf3D provides commands corresponding to the QuickDraw commands but using real coordinates instead of integers. With real coordinates you have a larger dynamic range for graphics calculations; with integer coordinates you get faster drawing time. For reals, the range is

$$1.4 \times 10^{-45} \quad \text{to} \quad 3.4 \times 10^{38}$$

- *Two-dimensional or three-dimensional rotation.* You can rotate an object along any or all axes simultaneously, using the Pitch, Yaw, and Roll procedures.
- *Translation and scaling of objects in one or more axes simultaneously.* Translation means movement anywhere in three-dimensional space. Scaling means shrinking or expanding.

### E.12.3 Graf3D Data Types

Graf3D declares and uses the following data types:

- Point3D:** A **Point3D** contains three real number coordinates: x, y, and z. Graf3D uses x, y, and z for real number coordinates to distinguish between the h and v integer screen coordinates in QuickDraw.
- Point2D:** A **Point2D** is just like a **Point3D** but contains only x and y coordinates.
- XfMatrix:** The **XfMatrix** is a 4x4 matrix of real values, used to hold a transformation equation. Each transforming routine alters this matrix so that it contains the concatenated effects of all transformations applied.
- Port3DPtr:** A **Port3DPtr** is a pointer to a **Port3D**.
- Port3D:** A **Port3D** contains all the state variables needed to map real number coordinates into integer screen coordinates. They are as follows:
- GPort:** a pointer to the grafPort associated with this **Port3D**.
  - viewRect:** the viewing rectangle within the grafPort; the base of the viewing pyramid.
  - xLeft, yTop, xRight, yBottom:** world coordinates corresponding to the **viewRect**.
  - pen:** three-dimensional pen location.
  - penPrime:** the pen location transformed by the **xForm** matrix.
  - eye:** three-dimensional viewpoint location established by **ViewAngle**.
  - hSize, vSize:** half-width and half-height of the **viewRect** in screen coordinates.
  - hCenter, vCenter:** center of the **viewRect** in screen coordinates.
  - xCotan, yCotan:** viewing cotangents set up by **ViewAngle**, used by **Cilp3D**.
  - ident:** a boolean that allows the transformation to be skipped when when **xForm** is an identity matrix.
  - xForm:** a 4x4 matrix that holds the net result of all transformations.

#### E.12.4 Graf3D Procedures and Functions

The following procedures and functions are provided in Graf3D.

**Procedure Open3DPort(port: Port3DPtr);**

Open3DPort initializes all the fields of a Port3D to their defaults, and makes that Port3D the current one. Gport is set to the currently open grafPort. The defaults established are:

```

thePort3D:=port;
port^.GPort:=thePort;
ViewPort(thePort^.portRect);
WITH thePort^.portRect DO LookAt(left, top, right, bottom);
ViewAngle(0);
Identity;
MoveTo3D(0, 0, 0);

```

**Procedure SetPort3D(port: Port3DPtr);**

SetPort3D makes port the current Port3D and calls SetPort for that Port3D's associated grafPort. SetPort3D allows an application to use more than one Port3D and switch between them.

**Procedure GetPort3D(var port: Port3DPtr);**

GetPort3D returns a pointer to the current Port3D. This procedure is useful when you are using several Port3Ds and want to save and restore the current one.

**Procedure MoveTo2D(x, y: real); Procedure MoveTo3D(x, y, z: real);**  
**Procedure Move2D(dx, dy: real); Procedure Move3D(dx, dy, dz: real);**

These procedures move the pen in two or three dimensions without drawing lines. The real number coordinates are transformed by the xForm matrix and projected onto flat screen coordinates; then Graf3D calls QuickDraw's MoveTo procedure with the result.

**Procedure LineTo2D(x, y: real); Procedure LineTo3D(x, y, z: real);**  
**Procedure Line2D(dx, dy: real); Procedure Line3D(dx, dy, dz: real);**

These procedures draw two- and three-dimensional lines from the current pen location. LineTo2D and Line2D stay on the same z-plane. The real number coordinates are first transformed by the xForm matrix, then clipped to the viewing pyramid, then projected onto the flat screen coordinates and drawn by calling QuickDraw's LineTo procedure.



**Function Clip3D(src1,src2: Point3D; var dst1,dst2: Point): boolean;**

Clip3D clips a three-dimensional line segment to the viewing pyramid and returns the clipped line projected onto screen coordinates. Clip3D returns **true** if any part of the line is visible. If no part of the line is within the viewing pyramid, Clip3D returns **false**.

**Procedure SetPt3D(var pt3D: Point3D; x,y,z: real);**

SetPt3D assigns three real numbers to a Point3D.

**Procedure SetPt2D(var pt2D: Point2D; x,y: real);**

SetPt2D assigns two real numbers to a Point2D.

#### **E.12.4.1 Setting Up the Camera (ViewPort, LookAt, and ViewAngle)**

Procedures ViewPort, LookAt and ViewAngle position the image in the grafPort, aim the camera, and choose the lens focal length in order to map three-dimensional coordinates onto the flat screen space. These procedures may be called in any order.

**Procedure ViewPort(r: Rect);**

ViewPort specifies where to put the image in the grafPort. The ViewPort rectangle is in integer QuickDraw coordinates, and tells where to map the LookAt coordinates.

**Procedure LookAt(left,top,right,bottom: real);**

LookAt specifies the real number x and y coordinates corresponding to the viewRect.

**Procedure ViewAngle(angle: real);**

ViewAngle controls the amount of perspective by specifying the horizontal angle (in degrees) subtended by the viewing pyramid. Typical viewing angles are 0° (no perspective), 10° (telephoto lens), 25° (normal perspective of the human eye), and 80° (wide angle lens).

#### **E.13.4.2 The Transformation Matrix**

The transformation matrix allows you to impose a coordinate transformation between the coordinates you plot and the viewing coordinates. Each of the transformation procedures concatenates a cumulative transformation onto the xForm matrix. Subsequent lines drawn are first transformed by the xForm matrix, then projected onto the screen as specified by ViewPort, LookAt, and ViewAngle.

**Procedure Identity;**

Identity resets the transformation matrix to an identity matrix.

**Procedure Scale(xFactor, yFactor, zFactor: real);**

Scale modifies the transformation matrix so as to shrink or expand by **xFactor**, **yFactor**, and **zFactor**. For example, **Scale(2.0,2.0,2.0)** will make everything come out twice as big when you draw.

**Procedure Translate(dx, dy, dz: real);**

Translate modifies the transformation matrix so as to displace by **dx,dy,dz**.

**Procedure Pitch(xAngle: real);**

Pitch modifies the transformation matrix so as to rotate **xAngle** degrees around the x axis. A positive angle rotates clockwise when looking at the origin from positive x.

**Procedure Yaw(yAngle: real);**

Yaw modifies the transformation matrix so as to rotate **yAngle** degrees around the y axis. A positive angle rotates clockwise when looking at the origin from positive y.

**Procedure Roll(zAngle: real);**

Roll modifies the transformation matrix so as to rotate **zAngle** degrees around the z axis. A positive angle rotates clockwise when looking at the origin from positive z.

**Procedure Skew(zAngle: real);**

Skew modifies the transformation matrix so as to skew **zAngle** degrees around the z axis. Skew only changes the x coordinate; the result is much like the slant QuickDraw gives to italic characters. (**Skew(15.0)** makes a reasonable italic.) A positive angle rotates clockwise when looking at the origin from positive z.

**Procedure Transform(src: Point3D; var dst: Point3D);**

Transform applies the **xForm** matrix to **src** and returns the result as **dst**. If the transformation matrix is identity, **dst** will be the same as **src**.

## E.13 QuickDraw Interface

```

UNIT QuickDraw;

{ Copyright 1983 Apple Computer Inc. }

INTERFACE

CONST srcCopy      = 0; { the 16 transfer modes }
      srcOr        = 1;
      srcXor       = 2;
      srcBic       = 3;
      notSrcCopy   = 4;
      notSrcOr     = 5;
      notSrcXor    = 6;
      notSrcBic    = 7;
      patCopy      = 8;
      patOr        = 9;
      patXor       = 10;
      patBic       = 11;
      notPatCopy   = 12;
      notPatOr     = 13;
      notPatXor    = 14;
      notPatBic    = 15;

{ QuickDraw color separation constants }

      normalBit    = 0;      { normal screen mapping }
      inverseBit   = 1;      { inverse screen mapping }
      redBit       = 4;      { RGB additive mapping }
      greenBit     = 3;
      blueBit      = 2;
      cyanBit      = 8;      { CMYBK subtractive mapping }
      magentaBit   = 7;
      yellowBit    = 6;
      blackBit     = 5;

      blackColor   = 33;     { colors expressed in these mappings }
      whiteColor   = 30;
      redColor     = 205;
      greenColor   = 341;
      blueColor    = 409;
      cyanColor    = 273;
      magentaColor = 137;
      yellowColor  = 69;

      picLParen    = 0;     { standard picture comments }
      picRParen    = 1;

```

```

TYPE QDByte   = -128..127;
   QDPtr     = ^QDByte;           { blind pointer }
   QDHandle  = ^QDPtr;           { blind handle  }
   Str255   = String[255];
   Pattern  = PACKED ARRAY[0..7] OF 0..255;
   Bits16   = ARRAY[0..15] OF INTEGER;
   VHSelect = (v,h);
   GrafVerb = (frame,paint,erase,invert,fill);
   StyleItem = (bold,italic,underline,outline,shadow,condense,
               extend);
   Style     = SET OF StyleItem;

FontInfo = RECORD
    ascent: INTEGER;
    descent: INTEGER;
    widMax: INTEGER;
    leading: INTEGER;
END;

Point = RECORD CASE INTEGER OF
    0: (v: INTEGER;
        h: INTEGER);
    1: (vh: ARRAY[VHSelect] OF INTEGER);
END;

Rect = RECORD CASE INTEGER OF
    0: (top:    INTEGER;
        left:   INTEGER;
        bottom: INTEGER;
        right:  INTEGER);
    1: (topLeft: Point;
        botRight: Point);
END;

```

```

Bitmap = RECORD
    baseAddr: QDPtr;
    rowBytes: INTEGER;
    bounds: Rect;
END;

Cursor = RECORD
    data: Bits16;
    mask: Bits16;
    hotSpot: Point;
END;

PenState = RECORD
    pnLoc: Point;
    pnSize: Point;
    pnMode: INTEGER;
    pnPat: Pattern;
END;

PolyHandle = ^PolyPtr;
PolyPtr = ^Polygon;
Polygon = RECORD
    polySize: INTEGER;
    polyBBox: Rect;
    polyPoints: ARRAY[0..0] OF Point;
END;

RgnHandle = ^RgnPtr;
RgnPtr = ^Region;
Region = RECORD
    rgnSize: INTEGER; { rgnSize = 10 for rectangular }
    rgnBBox: Rect;
    { plus more data if not rectangular }
END;

PicHandle = ^PicPtr;
PicPtr = ^Picture;
Picture = RECORD
    picSize: INTEGER;
    picFrame: Rect;
    { plus byte codes for picture content }
END;

```

```
QDProcsPtr = ^QDProcs;
QDProcs = RECORD
    textProc:    QDPtr;
    lineProc:    QDPtr;
    rectProc:    QDPtr;
    rRectProc:   QDPtr;
    ovalProc:    QDPtr;
    arcProc:     QDPtr;
    polyProc:    QDPtr;
    rgnProc:     QDPtr;
    bitsProc:    QDPtr;
    commentProc: QDPtr;
    txMeasProc:  QDPtr;
    getPicProc:  QDPtr;
    putPicProc:  QDPtr;
END;

GrafPtr = ^GrafPort;
GrafPort = RECORD
    device:      INTEGER;
    portBits:    BitMap;
    portRect:    Rect;
    visRgn:      RgnHandle;
    clipRgn:     RgnHandle;
    bkPat:       Pattern;
    fillPat:     Pattern;
    pnLoc:       Point;
    pnSize:      Point;
    pnMode:      INTEGER;
    pnPat:       Pattern;
    pnVis:       INTEGER;
    txFont:      INTEGER;
    txFace:      Style;
    txMode:      INTEGER;
    txSize:      INTEGER;
    spExtra:     LongInt;
    fgColor:     LongInt;
    bkColor:     LongInt;
    colrBit:     INTEGER;
    patStretch:  INTEGER;
    picSave:     QDHandle;
    rgnSave:     QDHandle;
```

```
    polySave:   QDHandle;  
    grafProcs: QDProcsPtr;  
END;
```

```
VAR thePort:   GrafPtr;  
    white:     Pattern;  
    black:     Pattern;  
    gray:      Pattern;  
    ltGray:    Pattern;  
    dkGray:    Pattern;  
    arrow:     Cursor;  
    screenBits: BitMap;  
    randSeed:  LongInt;
```

```
{ GrafPort Routines }
```

```
PROCEDURE InitGraf   (globalPtr: QDPtr);  
PROCEDURE OpenPort  (port: GrafPtr);  
PROCEDURE InitPort  (port: GrafPtr);  
PROCEDURE ClosePort (port: GrafPtr);  
PROCEDURE SetPort   (port: GrafPtr);  
PROCEDURE GetPort   (VAR port: GrafPtr);  
PROCEDURE GrafDevice (device: INTEGER);  
PROCEDURE SetPortBits (bm: BitMap);  
PROCEDURE PortSize   (width,height: INTEGER);  
PROCEDURE MovePortTo (leftGlobal,topGlobal: INTEGER);  
PROCEDURE SetOrigin  (h,v: INTEGER);  
PROCEDURE SetClip    (rgn: RgnHandle);  
PROCEDURE GetClip    (rgn: RgnHandle);  
PROCEDURE ClipRect   (r: Rect);  
PROCEDURE BackPat    (pat: Pattern);
```

```
{ Cursor Routines }
```

```
PROCEDURE InitCursor;  
PROCEDURE SetCursor (crsr: Cursor);  
PROCEDURE HideCursor;  
PROCEDURE ShowCursor;  
PROCEDURE ObscureCursor;
```

## { Line Routines }

```

PROCEDURE HidePen;
PROCEDURE ShowPen;
PROCEDURE GetPen      (VAR pt: Point);
PROCEDURE GetPenState(VAR pnState: PenState);
PROCEDURE SetPenState(pnState: PenState);
PROCEDURE PenSize    (width,height: INTEGER);
PROCEDURE PenMode    (mode: INTEGER);
PROCEDURE PenPat     (pat: Pattern);
PROCEDURE PenNormal;
PROCEDURE MoveTo     (h,v: INTEGER);
PROCEDURE Move       (dh,dv: INTEGER);
PROCEDURE LineTo    (h,v: INTEGER);
PROCEDURE Line       (dh,dv: INTEGER);

```

## { Text Routines }

```

PROCEDURE TextFont    (font: INTEGER);
PROCEDURE TextFace    (face: Style);
PROCEDURE TextMode    (mode: INTEGER);
PROCEDURE TextSize    (size: INTEGER);
PROCEDURE SpaceExtra  (extra: LongInt);
PROCEDURE DrawChar    (ch: char);
PROCEDURE DrawString  (s: Str255);
PROCEDURE DrawText    (textBuf: QDPtr; firstByte,byteCount: INTEGER);
FUNCTION CharWidth    (ch: CHAR): INTEGER;
FUNCTION StringWidth  (s: Str255): INTEGER;
FUNCTION TextWidth    (textBuf: QDPtr; firstByte,byteCount: INTEGER):
    INTEGER;
PROCEDURE GetFontInfo (VAR info: FontInfo);

```

## { Point Calculations }

```

PROCEDURE AddPt      (src: Point; VAR dst: Point);
PROCEDURE SubPt      (src: Point; VAR dst: Point);
PROCEDURE SetPt      (VAR pt: Point; h,v: INTEGER);
FUNCTION EqualPt     (pt1,pt2: Point): BOOLEAN;
PROCEDURE ScalePt    (VAR pt: Point;    fromRect,toRect: Rect);
PROCEDURE MapPt      (VAR pt: Point;    fromRect,toRect: Rect);
PROCEDURE LocalToGlobal (VAR pt: Point);
PROCEDURE GlobalToLocal (VAR pt: Point);

```



## { Rectangle Calculations }

```
PROCEDURE SetRect (VAR r: Rect; left, top, right, bottom: INTEGER);
FUNCTION EqualRect (rect1, rect2: Rect): BOOLEAN;
FUNCTION EmptyRect (r: Rect): BOOLEAN;
PROCEDURE OffsetRect (VAR r: Rect; dh, dv: INTEGER);
PROCEDURE MapRect (VAR r: Rect; fromRect, toRect: Rect);
PROCEDURE InsetRect (VAR r: Rect; dh, dv: INTEGER);
FUNCTION SectRect (src1, src2: Rect; VAR dstRect: Rect): BOOLEAN;
PROCEDURE UnionRect (src1, src2: Rect; VAR dstRect: Rect);
FUNCTION PtInRect (pt: Point; r: Rect): BOOLEAN;
PROCEDURE Pt2Rect (pt1, pt2: Point; VAR dstRect: Rect);
```

## { Graphical Operations on Rectangles }

```
PROCEDURE FrameRect (r: Rect);
PROCEDURE PaintRect (r: Rect);
PROCEDURE EraseRect (r: Rect);
PROCEDURE InvertRect (r: Rect);
PROCEDURE FillRect (r: Rect; pat: Pattern);
```

## { RoundRect Routines }

```
PROCEDURE FrameRoundRect (r: Rect; ovWd, ovHt: INTEGER);
PROCEDURE PaintRoundRect (r: Rect; ovWd, ovHt: INTEGER);
PROCEDURE EraseRoundRect (r: Rect; ovWd, ovHt: INTEGER);
PROCEDURE InvertRoundRect (r: Rect; ovWd, ovHt: INTEGER);
PROCEDURE FillRoundRect (r: Rect; ovWd, ovHt: INTEGER; pat: Pattern);
```

## { Oval Routines }

```
PROCEDURE FrameOval (r: Rect);
PROCEDURE PaintOval (r: Rect);
PROCEDURE EraseOval (r: Rect);
PROCEDURE InvertOval (r: Rect);
PROCEDURE FillOval (r: Rect; pat: Pattern);
```

## { Arc Routines }

```
PROCEDURE FrameArc (r: Rect; startAngle, arcAngle: INTEGER);
PROCEDURE PaintArc (r: Rect; startAngle, arcAngle: INTEGER);
PROCEDURE EraseArc (r: Rect; startAngle, arcAngle: INTEGER);
PROCEDURE InvertArc (r: Rect; startAngle, arcAngle: INTEGER);
```

```
PROCEDURE FillArc (r: Rect; startAngle, arcAngle: INTEGER; pat:
    Pattern);
```

```
PROCEDURE PtToAngle (r: Rect; pt: Point; VAR angle: INTEGER);
```

```
{ Polygon Routines }
```

```
FUNCTION OpenPoly: PolyHandle;
PROCEDURE ClosePoly;
PROCEDURE KillPoly (poly: PolyHandle);
PROCEDURE OffsetPoly (poly: PolyHandle; dh, dv: INTEGER);
PROCEDURE MapPoly (poly: PolyHandle; fromRect, toRect: Rect);
PROCEDURE FramePoly (poly: PolyHandle);
PROCEDURE PaintPoly (poly: PolyHandle);
PROCEDURE ErasePoly (poly: PolyHandle);
PROCEDURE InvertPoly (poly: PolyHandle);
PROCEDURE FillPoly (poly: PolyHandle; pat: Pattern);
```

```
{ Region Calculations }
```

```
FUNCTION NewRgn: RgnHandle;
PROCEDURE DisposeRgn(rgn: RgnHandle);
PROCEDURE CopyRgn (srcRgn, dstRgn: RgnHandle);
PROCEDURE SetEmptyRgn(rgn: RgnHandle);
PROCEDURE SetRectRgn(rgn: RgnHandle; left, top, right, bottom: INTEGER);
PROCEDURE RectRgn (rgn: RgnHandle; r: Rect);
PROCEDURE OpenRgn;
PROCEDURE CloseRgn (dstRgn: RgnHandle);
PROCEDURE OffsetRgn (rgn: RgnHandle; dh, dv: INTEGER);
PROCEDURE MapRgn (rgn: RgnHandle; fromRect, toRect: Rect);
PROCEDURE InsetRgn (rgn: RgnHandle; dh, dv: INTEGER);
PROCEDURE SectRgn (srcRgnA, srcRgnB, dstRgn: RgnHandle);
PROCEDURE UnionRgn (srcRgnA, srcRgnB, dstRgn: RgnHandle);
PROCEDURE DiffRgn (srcRgnA, srcRgnB, dstRgn: RgnHandle);
PROCEDURE XorRgn (srcRgnA, srcRgnB, dstRgn: RgnHandle);
FUNCTION EqualRgn (rgnA, rgnB: RgnHandle): BOOLEAN;
FUNCTION EmptyRgn (rgn: RgnHandle): BOOLEAN;
FUNCTION PtInRgn (pt: Point; rgn: RgnHandle): BOOLEAN;
FUNCTION RectInRgn (r: Rect; rgn: RgnHandle): BOOLEAN;
```

```
{ Graphical Operations on Regions }
```

```
PROCEDURE FrameRgn (rgn: RgnHandle);
PROCEDURE PaintRgn (rgn: RgnHandle);
PROCEDURE EraseRgn (rgn: RgnHandle);
```

```

PROCEDURE InvertRgn (rgn: RgnHandle);
PROCEDURE FillRgn (rgn: RgnHandle; pat: Pattern);

{ Graphical Operations on BitMaps }

PROCEDURE ScrollRect(dstRect: Rect; dh,dv: INTEGER; updateRgn:
                    rgnHandle);
PROCEDURE CopyBits (srcBits,dstBits: BitMap;
                    srcRect,dstRect: Rect;
                    mode:          INTEGER;
                    maskRgn:      RgnHandle);

{ Picture Routines }

FUNCTION  OpenPicture(picFrame: Rect): PicHandle;
PROCEDURE ClosePicture;
PROCEDURE DrawPicture(myPicture: PicHandle; dstRect: Rect);
PROCEDURE PicComment(kind,dataSize: INTEGER; dataHandle: QDHandle);
PROCEDURE KillPicture(myPicture: PicHandle);

{ The Bottleneck Interface:  }

PROCEDURE SetStdProcs(VAR procs: QDProcs);
PROCEDURE StdText (count: INTEGER; textAddr: QDPtr; numer,denom:
                  Point);
PROCEDURE StdLine (newPt: Point);
PROCEDURE StdRect (verb: GrafVerb; r: Rect);
PROCEDURE StdRRect (verb: GrafVerb; r: Rect; ovWd,ovHt: INTEGER);
PROCEDURE StdOval (verb: GrafVerb; r: Rect);
PROCEDURE StdArc (verb: GrafVerb; r: Rect; startAngle,arcAngle:
                  INTEGER);
PROCEDURE StdPoly (verb: GrafVerb; poly: PolyHandle);
PROCEDURE StdRgn (verb: GrafVerb; rgn: RgnHandle);
PROCEDURE StdBits (VAR srcBits: BitMap; VAR srcRect,dstRect: Rect;
                  mode: INTEGER; maskRgn: RgnHandle);
PROCEDURE StdComment (kind,dataSize: INTEGER; dataHandle: QDHandle);
FUNCTION StdTxMeas (count: INTEGER; textAddr: QDPtr;
                  VAR numer,denom: Point;
                  VAR info: FontInfo): INTEGER;
PROCEDURE StdGetPic (dataPtr: QDPtr; byteCount: INTEGER);
PROCEDURE StdPutPic (dataPtr: QDPtr; byteCount: INTEGER);

```

```

{ Misc Utility Routines }

FUNCTION GetPixel (h,v: INTEGER): BOOLEAN;
FUNCTION Random: INTEGER;
PROCEDURE StuffHex (thingptr: QDPtr; s:Str255);
PROCEDURE ForeColor (color: LongInt);
PROCEDURE BackColor (color: LongInt);
PROCEDURE ColorBit (whichBit: INTEGER);

```

### E.13.1 Graf3D Interface

```

{$S Graf }

UNIT Graf3D;

{ three-dimensional graphics routines layered on top of QuickDraw }

INTERFACE

USES {$U QD/QuickDraw.OBJ } QuickDraw;

CONST radConst=57.29578;

TYPE Point3D=RECORD
    x: REAL;
    y: REAL;
    z: REAL;
END;

Point2D=RECORD
    x: REAL;
    y: REAL;
END;

XfMatrix = ARRAY[0..3,0..3] OF REAL;
Port3DPtr = ^Port3D;
Port3D = RECORD
    GPort: GrafPtr;
    viewRect: Rect;
    xLeft,yTop,xRight,yBottom: REAL;
    pen,penPrime,eye: Point3D;
    hSize,vSize: REAL;
    hCenter,vCenter: REAL;
    xCotan,yCotan: REAL;
    ident: BOOLEAN;
    xForm: XfMatrix;
END;

```

```
VAR thePort3D: Port3DPtr;

PROCEDURE Open3DPort (port: Port3DPtr);
PROCEDURE SetPort3D (port: Port3DPtr);
PROCEDURE GetPort3D (VAR port: Port3DPtr);

PROCEDURE MoveTo2D(x, y: REAL); PROCEDURE MoveTo3D(x, y, z: REAL);
PROCEDURE LineTo2D(x, y: REAL); PROCEDURE LineTo3D(x, y, z: REAL);
PROCEDURE Move2D(dx, dy: REAL); PROCEDURE Move3D(dx, dy, dz: REAL);
PROCEDURE Line2D(dx, dy: REAL); PROCEDURE Line3D(dx, dy, dz: REAL);

PROCEDURE ViewPort (r: Rect);
PROCEDURE LookAt (left, top, right, bottom: REAL);
PROCEDURE ViewAngle (angle: REAL);
PROCEDURE Identity;
PROCEDURE Scale (xFactor, yFactor, zFactor: REAL);
PROCEDURE Translate (dx, dy, dz: REAL);
PROCEDURE Pitch (xAngle: REAL);
PROCEDURE Yaw (yAngle: REAL);
PROCEDURE Roll (zAngle: REAL);
PROCEDURE Skew (zAngle: REAL);
PROCEDURE TransForm (src: Point3D; VAR dst: Point3D);
FUNCTION Clip3D (src1, src2: Point3D; VAR dst1, dst2: POINT):
    BOOLEAN;

PROCEDURE SetPt3D (VAR pt3D: Point3D; x, y, z: REAL);
PROCEDURE SetPt2D (VAR pt2D: Point2D; x, y: REAL);
```

**E.14 QuickDraw Sample Programs**

This section provides listings of two sample programs that are included with the Workshop software.

**E.14.1 QDSample**

The program **QDSample** (in the file **QD/QDSample.TEXT**) demonstrates different things that QuickDraw can do. Its output is shown in Figure E-26.

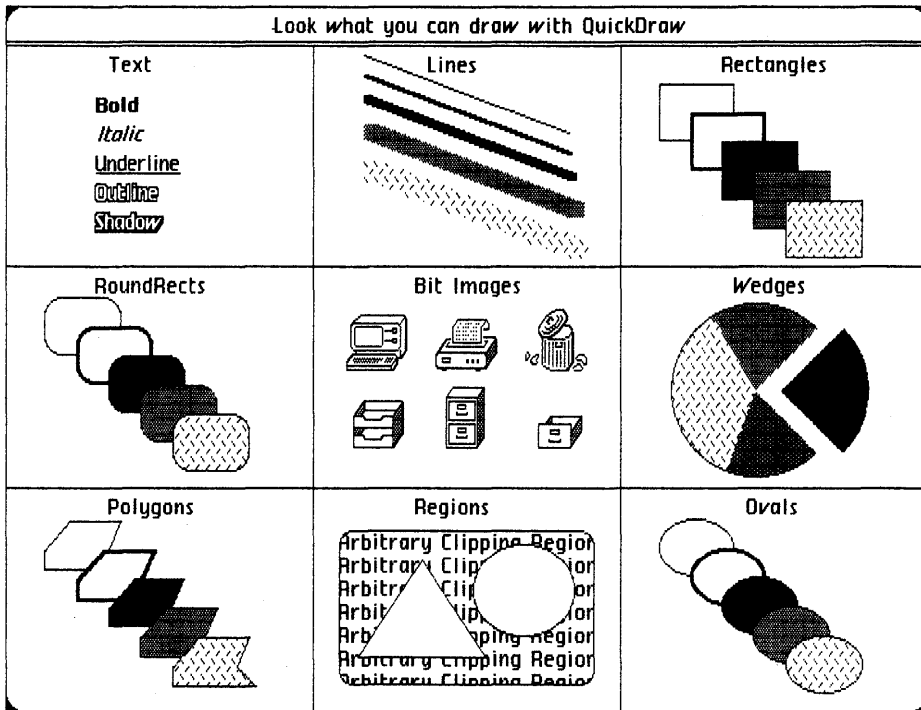

**Figure E-26**  
**QDSample**

The file **QD/M/QDSample.TEXT** is an exec file that can be used to rebuild this sample program. Disregard any warning messages from the linker about name conflicts.



```

{ Trash Can }
StuffHex(@icons[2, 0], '000001FC00000000E06000000030030000000C0918000');
StuffHex(@icons[2, 12], '00013849800000026C4980000004C0930000000861260000');
StuffHex(@icons[2, 24], '0010064FE0000031199830000020E63018000002418E00800');
StuffHex(@icons[2, 36], '0033E3801C0000180E002C00000FF801CC0000047FFE0C00');
StuffHex(@icons[2, 48], '000500004C000005259A4C000005250A4C00000525FA4C00');
StuffHex(@icons[2, 60], '000524024C00000524924C00600524924C0090E524924C7C');
StuffHex(@icons[2, 72], '932524924C82A44524924D01C88524924CF10C4524924C09');
StuffHex(@icons[2, 84], '0784249258E70003049233100000E000E40800001FFFC3F0');

{ tray }
StuffHex(@icons[3, 0], '000000000000000000000000000000000000000000000000');
StuffHex(@icons[3, 12], '000000000000000000000000000000000000000000007FFFFFF0');
StuffHex(@icons[3, 24], '000E0000018001A00000038003600000078006A000000D8');
StuffHex(@icons[3, 36], '00D7FFFFFFB801AC000003580358000006B807FC000FFD58');
StuffHex(@icons[3, 48], '040600180AB80403FFF00D5804000000AB804000000D58');
StuffHex(@icons[3, 60], '04000000AB807FFFFFFFD5806AC00000AB8055800000D58');
StuffHex(@icons[3, 72], '06B00000AB807FC000FFD70040600180AE00403FFF00DC0');
StuffHex(@icons[3, 84], '04000000B8004000000F0004000000E0007FFFFFFC00');

{ File Cabinet }
StuffHex(@icons[4, 0], '0007FFFFFFC00000800000C00001000001C00002000003400');
StuffHex(@icons[4, 12], '004000006C0000FFFFFFD40000800000AC0000BFFFFFFD400');
StuffHex(@icons[4, 24], '00A00002AC0000A07F02D40000A04102AC0000A07F02D400');
StuffHex(@icons[4, 36], '00A00002AC0000A08082D40000A0FF82AC0000A00002D400');
StuffHex(@icons[4, 48], '00A00002AC0000BFFFFFFE40000800000AC0000BFFFFFFD400');
StuffHex(@icons[4, 60], '00A00002AC0000A07F02D40000A04102AC0000A07F02D400');
StuffHex(@icons[4, 72], '00A00002AC0000A08082D40000A0FF82AC0000A00002D800');
StuffHex(@icons[4, 84], '00A00002B00000BFFFFFFE00000800000C00000FFFFFF8000');

{ drawer }
StuffHex(@icons[5, 0], '000000000000000000000000000000000000000000000000');
StuffHex(@icons[5, 12], '000000000000000000000000000000000000000000000000');
StuffHex(@icons[5, 24], '000000000000000000000000000000000000000000000000');
StuffHex(@icons[5, 36], '000000000000000000000000000000000000000000001FFFFFF0');
StuffHex(@icons[5, 48], '0000380000300000680000700000080000000003FFFFFF1B0');
StuffHex(@icons[5, 60], '0020000013500020000016B000201FE01D50002010201AB0');
StuffHex(@icons[5, 72], '00201FE01560002000001AC0002000001580002020101B00');
StuffHex(@icons[5, 84], '00203FF01600002000001C00002000001800003FFFFFF000');

```

END;



```
PROCEDURE DrawIcon(whichIcon, h, v: INTEGER);
VAR srcBits: BitMap;
    srcRect, dstRect: Rect;
BEGIN
  srcBits.baseAddr:=@icons[whichIcon];
  srcBits.rowBytes:=6;
  SetRect(srcBits.bounds, 0, 0, 48, 32);
  srcRect:=srcBits.bounds;
  dstRect:=srcRect;
  OffsetRect(dstRect, h, v);
  CopyBits(srcBits, thePort^.portBits, srcRect, dstRect, srcOr, Nil);
END;
```

```
PROCEDURE DrawStuff;
```

```
VAR i: INTEGER;
    tempRect: Rect;
    myPoly: PolyHandle;
    myRgn: RgnHandle;
    myPattern: Pattern;

BEGIN
  StuffHex(@myPattern, '8040200002040800');

  tempRect := thePort^.portRect;
  ClipRect(tempRect);
  EraseRoundRect(tempRect, 30, 20);
  FrameRoundRect(tempRect, 30, 20);

  { draw two horizontal lines across the top }
  MoveTo(0, 18);
  LineTo(719, 18);
  MoveTo(0, 20);
  LineTo(719, 20);

  { draw divider lines }
  MoveTo(0, 134);
  LineTo(719, 134);
  MoveTo(0, 248);
  LineTo(719, 248);
  MoveTo(240, 21);
  LineTo(240, 363);
  MoveTo(480, 21);
  LineTo(480, 363);
```

```
{ draw title }
TextFont(0);
MoveTo(210,14);
DrawString('Look what you can draw with QuickDraw');
```

```
{----- draw text samples ----- }
```

```
MoveTo(80,34); DrawString('Text');
```

```
TextFace([bold]);
MoveTo(70,55); DrawString('Bold');
```

```
TextFace([italic]);
MoveTo(70,70); DrawString('Italic');
```

```
TextFace([underline]);
MoveTo(70,85); DrawString('Underline');
```

```
TextFace([outline]);
MoveTo(70,100); DrawString('Outline');
```

```
TextFace([shadow]);
MoveTo(70,115); DrawString('Shadow');
```

```
TextFace([]); { restore to normal }
```

```
{ ----- draw line samples ----- }
```

```
MoveTo(330,34); DrawString('Lines');
```

```
MoveTo(280,25); Line(160,40);
```

```
PenSize(3,2);
MoveTo(280,35); Line(160,40);
```

```
PenSize(6,4);
MoveTo(280,46); Line(160,40);
```

```
PenSize(12,8);
PenPat(gray);
MoveTo(280,61); Line(160,40);
```

```
PenSize(15, 10);
PenPat(myPattern);
MoveTo(280, 80); Line(160, 40);
PenNormal;

{ ----- draw rectangle samples ----- }

MoveTo(560, 34); DrawString('Rectangles');

SetRect(tempRect, 510, 40, 570, 70);
FrameRect(tempRect);

OffsetRect(tempRect, 25, 15);
PenSize(3, 2);
EraseRect(tempRect);
FrameRect(tempRect);

OffsetRect(tempRect, 25, 15);
PaintRect(tempRect);

OffsetRect(tempRect, 25, 15);
PenNormal;
FillRect(tempRect, gray);
FrameRect(tempRect);

OffsetRect(tempRect, 25, 15);
FillRect(tempRect, myPattern);
FrameRect(tempRect);

{ ----- draw roundRect samples ----- }

MoveTo(70, 148); DrawString('RoundRects');

SetRect(tempRect, 30, 150, 90, 180);
FrameRoundRect(tempRect, 30, 20);

OffsetRect(tempRect, 25, 15);
PenSize(3, 2);
EraseRoundRect(tempRect, 30, 20);
FrameRoundRect(tempRect, 30, 20);

OffsetRect(tempRect, 25, 15);
PaintRoundRect(tempRect, 30, 20);
```

```

OffsetRect(tempRect, 25, 15);
PenNormal;
FillRoundRect(tempRect, 30, 20, gray);
FrameRoundRect(tempRect, 30, 20);

OffsetRect(tempRect, 25, 15);
FillRoundRect(tempRect, 30, 20, myPattern);
FrameRoundRect(tempRect, 30, 20);

{ ----- draw bit image samples ----- }

MoveTo(320, 148); DrawString('Bit Images');

DrawIcon(0, 266, 156);
DrawIcon(1, 336, 156);
DrawIcon(2, 406, 156);
DrawIcon(3, 266, 196);
DrawIcon(4, 336, 196);
DrawIcon(5, 406, 196);

{ ----- draw Wedge samples ----- }

MoveTo(570, 148); DrawString('Wedges');

SetRect(tempRect, 520, 153, 655, 243);
FillArc(tempRect, 135, 65, dkGray);
FillArc(tempRect, 200, 130, myPattern);
FillArc(tempRect, 330, 75, gray);
FrameArc(tempRect, 135, 270);
OffsetRect(tempRect, 20, 0);
PaintArc(tempRect, 45, 90);

{ ----- draw polygon samples ----- }

MoveTo(80, 262); DrawString('Polygons');
myPoly:=OpenPoly;
  MoveTo(30, 290);
  LineTo(30, 280);
  LineTo(50, 265);
  LineTo(90, 265);
  LineTo(80, 280);
  LineTo(95, 290);
  LineTo(30, 290);
ClosePoly;      { end of definition }

```

```
FramePoly(myPoly);

OffsetPoly(myPoly, 25, 15);
PenSize(3, 2);
ErasePoly(myPoly);
FramePoly(myPoly);

OffsetPoly(myPoly, 25, 15);
PaintPoly(myPoly);

OffsetPoly(myPoly, 25, 15);
PenNormal;
FillPoly(myPoly, gray);
FramePoly(myPoly);

OffsetPoly(myPoly, 25, 15);
FillPoly(myPoly, myPattern);
FramePoly(myPoly);

KillPoly(myPoly);

{ ----- demonstrate region clipping ----- }

MoveTo(320, 262); DrawString('Regions');

myRgn:=NewRgn;
OpenRgn;
  ShowPen;

  SetRect(tempRect, 260, 270, 460, 350);
  FrameRoundRect(tempRect, 24, 16);

  MoveTo(275, 335); { define triangular hole }
  LineTo(325, 285);
  LineTo(375, 335);
  LineTo(275, 335);

  SetRect(tempRect, 365, 277, 445, 325); { oval hole }
  FrameOval(tempRect);

  HidePen;
CloseRgn(myRgn);      { end of definition }

SetClip(myRgn);
```

```
FOR i:=0 TO 6 DO { draw stuff inside the clip region }
  BEGIN
    MoveTo(260,280+12*i);
    DrawString('Arbitrary Clipping Regions');
  END;

ClipRect(thePort^.portRect);
DisposeRgn(myRgn);

{ ----- draw oval samples ----- }

MoveTo(580,262); DrawString('Ovals');

SetRect(tempRect,510,264,570,294);
FrameOval(tempRect);

OffsetRect(tempRect,25,15);
PenSize(3,2);
EraseOval(tempRect);
FrameOval(tempRect);

OffsetRect(tempRect,25,15);
PaintOval(tempRect);

OffsetRect(tempRect,25,15);
PenNormal;
FillOval(tempRect,gray);
FrameOval(tempRect);

OffsetRect(tempRect,25,15);
FillOval(tempRect,myPattern);
FrameOval(tempRect);
END; { DrawStuff }
```

```
BEGIN { main program }
  { Initialization - Generic to all applications using QuickDraw }
  QDInit(@heapBuf, @heapBuf[10000], @HeapFull); { Must do this once at
                                                    beginning }
  OpenPort(@myPort);
  PaintRect(thePort^.portRect); { Paint grey background }

  InitIcons;
  DrawStuff;
  Tone(2000, 500); { Beep tone of  $(1/2000) \cdot 10^6$  == 500 cycles/sec for
                    500 milliseconds }
  ReadLn; { Wait until RETURN entered before terminating program }
END.
```

**E.14.2 Boxes**

The program `Boxes` (in the file `QD/Boxes.TEXT`) uses the `Graf3D` routines to draw random three-dimensional boxes on a grid, as shown in Figure E-27.

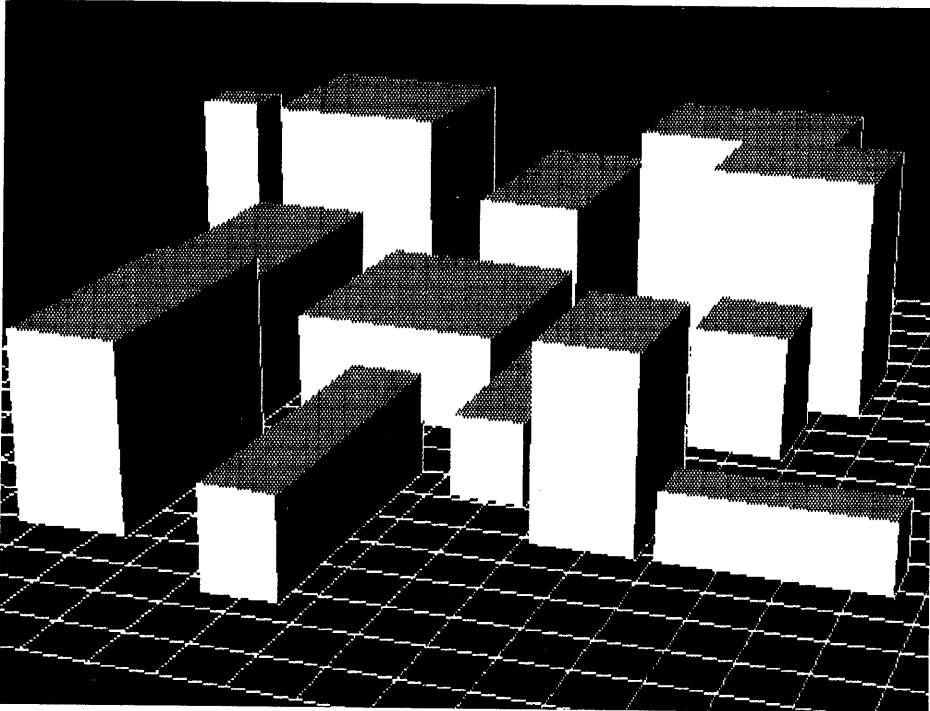

**Figure E-27**  
**Boxes**

The file `QD/M/Boxes.TEXT` is an exec file that can be used to rebuild this sample program. Disregard any warning messages from the linker about name conflicts.



```

PROGRAM Boxes;

{ Sample program illustrating use of the Graf3D unit by drawing random
  3D boxes on a grid. }

USES
  {$U QD/QuickDraw.OBJ } QuickDraw,
  {$U QD/Graf3D.OBJ } Graf3D,
  {$U QD/QDSupport.OBJ } QDSupport,

CONST boxCount = 15;

TYPE Box3D=RECORD
  pt1: Point3D;
  pt2: Point3D;
  dist: REAL;
END;

VAR
  heapBuf: ARRAY[0..8192] OF INTEGER; {16k bytes}
  GPort1: GrafPort;
  GPort2: Port3d;
  myPort: GrafPtr;
  myPort3D: Port3DPtr;
  boxArray: ARRAY[0..boxCount] OF Box3D;
  nBoxes: INTEGER;
  i: INTEGER;

FUNCTION HeapError(hz: QDPtr; bytesNeeded: INTEGER): INTEGER;
{ this procedure gets called when the heap zone is full }
BEGIN
  WRITELN('The heap is full. The program must now terminate! ');
  HALT;
END;

FUNCTION Distance(pt1,pt2: POINT3D): REAL;
VAR dx,dy,dz: REAL;
BEGIN
  dx:=pt2.X - pt1.X;
  dy:=pt2.Y - pt1.Y;
  dz:=pt2.Z - pt1.Z;
  Distance:=SQRT(dx*dx + dy*dy + dz*dz);
END;

```

```

PROCEDURE MakeBox;

VAR myBox:      Box3D;
    i, j, h, v: INTEGER;
    p1, p2:     Point3D;
    myRect:     Rect;
    testRect:   Rect;

BEGIN
  p1.x:=Random mod 70-15;
  p1.y:=Random mod 70 -10;
  p1.z:=0.0;
  p2.x:=p1.x + 10 + ABS(Random) MOD 30;
  p2.y:=p1.y + 10 + ABS(Random) MOD 45;
  p2.z:=p1.z + 10 + ABS(Random) MOD 35;

  { reject box if it intersects one already in list }
  SetRect(myRect, ROUND(p1.x), ROUND(p1.y), ROUND(p2.x), ROUND(p2.y));
  FOR i:=0 TO nBoxes-1 DO
    BEGIN
      WITH boxArray[i] DO
        SetRect(testRect, ROUND(pt1.x), ROUND(pt1.y),
                ROUND(pt2.x), ROUND(pt2.y));
        IF SectRect(myRect, testRect, testRect) THEN EXIT(MakeBox);
    END;

  myBox.pt1:=p1;
  myBox.pt2:=p2;

  { calc midpoint of box and its distance from the eye }
  p1.x:=(p1.x + p2.x)/2.0;
  p1.y:=(p1.y + p2.y)/2.0;
  p1.z:=(p1.z + p2.z)/2.0;
  Transform(p1, p2);
  myBox.dist:=Distance(p2, myPort3D^.eye); { distance to eye }

  i:=0;
  boxArray[nBoxes].dist:=myBox.dist; { sentinel }
  WHILE myBox.dist > boxArray[i].dist DO i:=i+1; {insert in order of dist}
  FOR j:=nBoxes DOWNTO i+1 DO boxArray[j]:=boxArray[j-1];
  boxArray[i]:=myBox;
  nBoxes:=nBoxes+1;
END;

```

```

PROCEDURE DrawBox(pt1,pt2: Point3D);
{ draws a 3D box with shaded faces. }
{ only shades correctly in one direction }
VAR tempRgn: RgnHandle;

BEGIN
  tempRgn:=NewRgn;
  OpenRgn;
  MoveTo3D(pt1.x,pt1.y,pt1.z); { front face, y=y1 }
  LineTo3D(pt1.x,pt1.y,pt2.z);
  LineTo3D(pt2.x,pt1.y,pt2.z);
  LineTo3D(pt2.x,pt1.y,pt1.z);
  LineTo3D(pt1.x,pt1.y,pt1.z);
  CloseRgn(tempRgn);
  FillRgn(tempRgn,white);

  OpenRgn;
  MoveTo3D(pt1.x,pt1.y,pt2.z); { top face, z=z2 }
  LineTo3D(pt1.x,pt2.y,pt2.z);
  LineTo3D(pt2.x,pt2.y,pt2.z);
  LineTo3D(pt2.x,pt1.y,pt2.z);
  LineTo3D(pt1.x,pt1.y,pt2.z);
  CloseRgn(tempRgn);
  FillRgn(tempRgn,gray);

  OpenRgn;
  MoveTo3D(pt2.x,pt1.y,pt1.z); { right face, x=x2 }
  LineTo3D(pt2.x,pt1.y,pt2.z);
  LineTo3D(pt2.x,pt2.y,pt2.z);
  LineTo3D(pt2.x,pt2.y,pt1.z);
  LineTo3D(pt2.x,pt1.y,pt1.z);
  CloseRgn(tempRgn);
  FillRgn(tempRgn,black);

  PenPat(white);
  MoveTo3D(pt2.x,pt2.y,pt2.z); { outline right }
  LineTo3D(pt2.x,pt2.y,pt1.z);
  LineTo3D(pt2.x,pt1.y,pt1.z);
  PenNormal;

  DisposeRgn(tempRgn);
END;

```

```

BEGIN { main program }
  { Initialization - Generic to all applications using QuickDraw }
  QDInit(@heapBuf, @heapBuf[8192], @heapError); { Must do this once at
                                                beginning )

  myPort := @GPort1;
  OpenPort(myPort);
  myPort3D := @GPort2;
  Open3DPort(myPort3D);

  ViewPort(myPort^.portRect);      { put the image in this rect }
  LookAt(-100, 75, 100, -75);      { aim the camera into 3D space }
  ViewAngle(30);                   { choose lens focal length }
  Identity; Roll(20); Pitch(70);   { roll and pitch the plane }

  PenPat(white);
  BackPat(black);
  EraseRect(myPort^.portRect);

  FOR i:=-10 TO 10 DO
    BEGIN
      MoveTo3D(i*10, -100, 0);
      LineTo3D(i*10, +100, 0);
    END;

  FOR i:=-10 TO 10 DO
    BEGIN
      MoveTo3D(-100, i*10, 0);
      LineTo3D(+100, i*10, 0);
    END;

  nBoxes:=0;
  REPEAT MakeBox; UNTIL nBoxes=boxCount;
  FOR i:=nBoxes-1 DOWNTO 0 DO
    DrawBox(boxArray[i].pt1, boxArray[i].pt2);

  Tone(2000, 500); {Beep tone of (1/2000)*10^6 == 500 cycles/sec for
                  500 milliseconds }
  ReadLn; { Wait until RETURN entered before terminating program }

END.

```

**E.15 QDSupport**

The **QDSupport** unit (in the file **QD/QDSupport.TEXT**) provides the initialization that you need to use QuickDraw in the **QDInit** procedure, as well as procedures for simplified access to mouse tracking, the mouse button, and sound generation, and useful definitions of font numbers. For more detailed information on mouse-handling routines and sound, refer to Appendix F, Hardware Interface.

```
UNIT QDSupport;
```

```
INTERFACE
```

```
USES
```

```
  {$U QD/UnitStd.OBJ } UnitStd,
  {$U QD/UnitHz.OBJ } UnitHz,
  {$U QD/Hardware.OBJ } Hardware,
  {$U QD/Fontmgr.OBJ } Fontmgr,
  {$U QD/QuickDraw.OBJ } QuickDraw;
```

```
CONST
```

```
{----- Font Numbers -----}
```

```
FTile12    = 4; {proportional}
FTile18    = 5; {proportional}
FTile24    = 6; {proportional}
FP15Tile   = 7; {Monospaced - 8 lines/inch & 15 chars/inch}
FP12Tile   = 8; {Monospaced - 6 lines/inch & 12 chars/inch}
FP10Tile   = 9; {Monospaced - 6 lines/inch & 10 chars/inch}
FCent12    = 10; {proportional}
FCent18    = 11; {proportional}
FCent24    = 12; {proportional}
FP12Cent   = 13; {Monospaced - 6 lines/inch & 12 chars/inch}
FP10Cent   = 14; {Monospaced - 6 lines/inch & 10 chars/inch}
FP20Tile   = 19; {Monospaced}
```

```
PROCEDURE QDInit(startPtr, limitPtr: QDPtr; ErrorProc: QDPtr);  
{ QDInit:      Initializes QuickDraw unit by setting up its heap  
               zone, global vars, cursor, and the Font Manager it  
               calls on. }
```

```
PROCEDURE GetMouse(VAR pt: Point);  
{ GetMouse:    Returns the current mouse location in the local  
               coordinates of the current grafPort. }
```

```
FUNCTION MouseButton: BOOLEAN;  
{ MouseButton: Returns TRUE if the mouse button is currently held  
               down, otherwise FALSE. }
```

```
PROCEDURE Tone(waveLength, duration: LongInt);  
{ Tone:        Produces a square wave tone of the specified  
               wavelength (microseconds) for the specified duration  
               (milliseconds). }
```

**E.16 Glossary**

**bit image:** A collection of bits in memory that have a rectilinear representation. The Lisa screen is a visible bit image.

**bitmap:** A pointer to a bit image, the row width of that image, and its boundary rectangle.

**boundary rectangle:** A rectangle defined as part of a bitmap, which encloses the active area of the bit image and imposes a coordinate system on it. Its top left corner is always aligned around the first bit in the bit image.

**camera eye:** A concept in three-dimensional graphics: the point of view and the viewing angle in which an object appears, independent of the object's coordinates.

**character style:** A set of stylistic variations, such as bold, italic, and underline. The empty set indicates normal text (no stylistic variations).

**clipping:** Limiting drawing to within the bounds of a particular area.

**clipping region:** Same as clipRgn.

**clipRgn:** The region to which an application limits drawing in a grafPort.

**coordinate plane:** A two-dimensional grid. In QuickDraw, the grid coordinates are integers ranging from -32768 to +32767, and all grid lines are infinitely thin.

**cursor:** A 16-by-16-bit image that appears on the screen and is controlled by the mouse.

**cursor level:** A value, initialized to 0 when the system is booted, that keeps track of the number of times the cursor has been hidden.

**empty:** Containing no bits, as a shape defined by only one point.

**font:** The complete set of characters of one typeface, such as Century.

**frame:** To draw a shape by drawing an outline of it.

**global coordinate system:** The coordinate system based on the top left corner of the bit image being at (0,0).

**Graf3D:** A three-dimensional graphics unit that calls QuickDraw routines.

**grafPort:** A complete drawing environment, including such elements as a bitmap, a subset of it in which to draw, a character font, patterns for drawing and erasing, and other pen characteristics.

**grafPtr:** A pointer to a grafPort.

**handle:** A pointer to one master pointer to a dynamic, relocatable data structure (such as a region).

**hotspot:** The point in a cursor that is aligned with the mouse position.

**kern:** To stretch part of a character back under the previous character.

**local coordinate system:** The coordinate system local to a grafPort, imposed by the boundary rectangle defined in its bitmap.

**missing symbol:** A character to be drawn in case of a request to draw a character that is missing from a particular font.

**pattern:** An 8-by-8-bit image, used to define a repeating design (such as stripes) or tone (such as gray).

**pattern transfer mode:** One of eight transfer modes for drawing lines or shapes with a pattern.

**picture:** A saved sequence of QuickDraw drawing commands (and, optionally, picture comments) that you can play back later with a single procedure call; also, the image resulting from these commands.

**picture comments:** Data stored in the definition of a picture which does not affect the picture's appearance but may be used to provide additional information about the picture when it's played back.

**picture frame:** A rectangle, defined as part of a picture, which surrounds the picture and gives a frame of reference for scaling when the picture is drawn.

**pixel:** The visual representation of a bit on the screen (white if the bit is 0, black if it's 1).

**point:** The intersection of a horizontal grid line and a vertical grid line on the coordinate plane, defined by a horizontal and a vertical coordinate.

**polygon:** A sequence of connected lines, defined by QuickDraw line-drawing commands.

**port:** GrafPort or Port3D.

**Port3D:** A data structure in Graf3D that maps three-dimensional coordinates into a two-dimensional QuickDraw grafPort.

**Port3DPtr:** A pointer to a Port3D.

**portBits:** The bitmap of a grafPort.

**portBits.bounds:** The boundary rectangle of a grafPort's bitmap.

**portRect:** A rectangle, defined as part of a grafPort, which encloses a subset of the bitmap for use by the grafPort.

**region:** An arbitrary area or set of areas on the coordinate plane. The outline of a region should be one or more closed loops.

**row width:** The number of bytes in each row of a bit image.

**scale:** To shrink or expand by a specified factor.

**solid:** Filled in with any pattern.

**source transfer mode:** One of eight transfer modes for drawing text or transferring any bit image between two bitmaps.



**style:** See character style.

**thePort:** A global variable that points to the current grafPort.

**thePort3D:** A global variable that points to the current Port3D.

**transfer mode:** A specification of which boolean operation QuickDraw should perform when drawing or when transferring a bit image from one bitmap to another.

**translate:** To move in three-dimensional space by a specified amount.

**transformation matrix:** Same as xForm matrix.

**viewing pyramid:** The portion of three-dimensional space that a camera eye can see. The pyramid's apex is the point of the camera eye; its base is the viewRect in a Port3D.

**visRgn:** The region of a grafPort which is actually visible on the screen.

**xForm matrix:** A 4x4 matrix that holds an equation to transform points plotted in three-dimensional coordinates into two-dimensional screen coordinates.

# Appendix F

## Hardware Interface

F.1	The Mouse .....	F-1
F.1.1	Mouse Location .....	F-1
F.1.2	Mouse Update Frequency .....	F-1
F.1.3	Mouse Scaling .....	F-1
F.1.4	Mouse Odometer .....	F-2
F.2	The Cursor .....	F-2
F.2.1	Cursor/Mouse Tracking.....	F-3
F.2.2	The Busy Cursor .....	F-3
F.3	The Display Screen.....	F-4
F.3.1	Screen Contrast .....	F-4
F.3.2	Automatic Screen Fading .....	F-4
F.4	The Speaker .....	F-5
F.5	The Keyboard.....	F-5
F.5.1	Keyboard Identification .....	F-7
F.5.2	Keyboard State .....	F-8
F.5.3	Keyboard Events.....	F-8
F.5.4	Dead Key Diacriticals .....	F-10
F.5.5	Repeats.....	F-11
F.6	The Microsecond Timer.....	F-11
F.7	The Millisecond Timer .....	F-12
F.8	Date and Time .....	F-12
F.9	Time Stamp .....	F-12
F.10	Interface of the Hardware Unit .....	F-13



# Hardware Interface

The hardware interface software provides an interface for accessing and controlling several parts of the Lisa hardware. The hardware/software capabilities addressed include the mouse, the cursor, the display, the contrast control, the speaker, both undecoded and decoded keyboard access, the micro-second and millisecond timers and the hardware clock/calendar.

This appendix contains Pascal procedure and function declarations interleaved with text describing them. Pascal type declarations and a summary of the function and procedure declarations can be found in Section F.10, Interface of the Hardware Unit.

Programs using this unit should be compiled against the file QD/Hardware.OBJ and linked to the file QD/HWIntL.OBJ.

## F.1 The Mouse

### F.1.1 Mouse Location

Procedure `MouseLocation` (`var x: Pixels; var y: Pixels`);

The *mouse* is a pointing device used to indicate screen locations. `MouseLocation` returns the location of the mouse. The X-coordinate can range from 0 to 719, and the Y-coordinate from 0 to 363. The initial mouse location is 0,0.

### F.1.2 Mouse Update Frequency

Procedure `MouseUpdates` (`delay: Milliseconds`);

Software knowledge of the mouse location is updated periodically, rather than continuously. The frequency of these updates can be set by calling `MouseUpdates`. The time between updates can range from 0 milliseconds (continuous updating) to 28 milliseconds, in intervals of 4 milliseconds. The initial setting is 16 milliseconds.

### F.1.3 Mouse Scaling

Procedure `MouseScaling` (`scale:Boolean`);

Procedure `MouseThresh` (`threshold: Pixels`);

The relationship between physical mouse movements and logical mouse movements is not necessarily a fixed linear mapping. Three alternatives are available: 1) *unscaled*, 2) scaled for fine movement and 3) scaled for coarse movement. Initially mouse movements are *unscaled*.

When mouse movement is *unscaled*, a horizontal mouse movement of *x* units yields a change in the mouse X-coordinate of *x* pixels. Similarly, a vertical movement of *y* units yields a change in the mouse Y-coordinate of *y* pixels. These rules apply independent of the speed of the mouse movement.

When mouse movement is *scaled*, horizontal movements are magnified by  $3/2$  relative to vertical movements. This is to compensate for the  $2/3$  aspect ratio of pixels on the screen. When scaling is in effect, a distinction is made between *fine* (small) movements and *coarse* (large) movements. Fine movements are slightly reduced, while coarse movements are magnified. For scaled fine movements, a horizontal mouse movement of  $x$  units yields a change in the X-coordinate of  $x$  pixels, but a vertical movement of  $y$  units yields a change of  $(2/3)*y$  pixels. For scaled coarse movements, a horizontal movement of  $x$  units yields a change of  $(3/2)*x$  pixels, while a vertical movement of  $y$  units yields a change of  $y$  pixels.

The distinction between fine movements and coarse movements is determined by the sum of the  $x$  and  $y$  movements each time the mouse location is updated. If this sum is at or below the *threshold* the movement is considered to be a fine movement. Values of the threshold range from 0 (which yields all coarse movements) to 256 (which yields all fine movements). Given the default mouse updating frequency, a threshold of about 8 (threshold's initial setting) gives a comfortable transition between fine and coarse movements.

`MouseScaling` enables and disables mouse scaling. `MouseThresh` sets the threshold between fine and coarse movements.

#### F.1.4 Mouse Odometer

Function `MouseOdometer`: `ManyPixels`;

In order to properly specify, design and test mice, it's important to estimate how far a mouse moves during its lifetime. `MouseOdometer` returns the sum of the X and Y movements of the mouse since boot time. The value returned is in (unscaled) pixels. There are 180 pixels per inch of mouse movement.

## F.2 The Cursor

Procedure `CursorImage` (`hotX`: `Pixels`; `hotY`: `Pixels`; `height`: `CursorHeight`; `data`: `CursorPtr`; `mask`: `CursorPtr`);

The *cursor* is a small image that is displayed on the screen. Its shape is specified by two bitmaps, called *data* and *mask*. These bitmaps are 16 bits wide and from 0 to 32 bits high. The rule used to combine the bits already on the screen with the data and mask is

```
screen <- (screen and (not mask)) xor data.
```

The effect is that white areas of the screen are replaced with the cursor data. Black areas of the screen are replaced with `(not mask) xor data`. If the data and mask bitmaps are identical, the effect is to or the data onto the screen.

The cursor has both a *location* and a *hotspot*. The location is a position on the screen, with X-coordinates of 0 to 719 and Y-coordinates of 0 to 363. The hotspot is a position within the cursor bitmaps, with X- and Y-coordinates ranging from 0 to 16. The cursor is displayed on the screen with its

hotspot at its location. If the cursor's location is near an edge of the screen, the cursor image may be partially or completely off the screen.

Most cursor operations can be performed by calling the `SetCursor`, `HideCursor`, `ShowCursor`, and `ObscureCursor` procedures defined by `QuickDraw` (see Section E.9.2, `Cursor-Handling Routines`). Additional capabilities are provided by the `Hardware Interface` routines described below.

The `CursorImage` procedure is used to specify the data bitmap, mask bitmap, height and hotspot of the cursor. Initially the cursor data and mask bitmaps contain all zeros, which yields a blank (invisible) cursor. The initial hotspot is 0,0.

### F.2.1 Cursor/Mouse Tracking

Procedure `CursorTracking` (`track`: Boolean);

Procedure `CursorLocation` (`x`: Pixels; `y`: Pixels);

`CursorTracking` enables and disables cursor *tracking* of the mouse. When tracking is enabled, the cursor location is changed to the mouse location each time the mouse moves. Setting the cursor location by calling `CursorLocation` will have no effect; the cursor sticks with the mouse.

When tracking is disabled, the mouse location and cursor location are independent. Calling `CursorLocation` will move the cursor; moving the mouse will not.

When tracking is first enabled (i.e., on each transition from disabled to enabled) the mouse location is modified to equal the cursor location. Therefore, enabling tracking does not move the cursor; it does modify the mouse location. Initially tracking is enabled.

### F.2.2 The Busy Cursor

Procedure `BusyImage` (`hotX`: Pixels; `hotY`: Pixels; `height`: CursorHeight; `data`: CursorPtr; `mask`: CursorPtr);

Procedure `BusyDelay` (`delay`: Milliseconds);

Applications may desire to display a *busy cursor* (e.g., an hourglass) when an operation in progress requires more than a few seconds to complete. The `BusyImage` procedure is used to specify the data bitmap, mask bitmap, height and hotspot of the busy cursor.

A call to `BusyDelay` specifies that the normal cursor should currently be displayed, and that display of the busy cursor should be delayed for the specified number of milliseconds. Subsequent calls to `BusyDelay` override previous calls, postponing display of the busy cursor. If no calls to `BusyDelay` occur for the specified number of milliseconds, the busy cursor will be displayed until the next call to `BusyDelay`.

Initially the busy cursor data and mask bitmaps contain all zeros, which yields a blank (invisible) cursor. The initial hotspot is 0,0. The initial busy delay is

infinite, that is, the busy cursor will not be displayed until `BusyDelay` is called.

### F.3 The Display Screen

**Procedure** `ScreenSize` (var x: Pixels; var y: Pixels);

The display screen is a *bit mapped display*; that is, each pixel on the screen is controlled by a bit in main memory. The display has 720 pixels horizontally and 364 lines vertically, and therefore requires 32,760 bytes of main memory. The screen size may be determined by calling `ScreenSize`.

**Function** `FrameCounter`: Frames;

The screen is redisplayed about 60 times per second. A *frame counter* is incremented between screen updates, at the vertical retrace interrupt. The frame counter is an unsigned 32-bit integer which is reset to 0 each time the machine is booted. `FrameCounter` returns this value. An application can synchronize with the vertical retraces by watching for changes in the value of this counter. The frame counter should *not* be used as a timer; use the millisecond and microsecond timers instead.

#### F.3.1 Screen Contrast

**Function** `Contrast`: ScreenContrast;

**Procedure** `SetContrast` (contrast: ScreenContrast);

The display's contrast level is under program control. Contrast values range from 0 to 255 (\$FF), with 0 as maximum contrast and 255 as minimum. `Contrast` returns the contrast setting; `SetContrast` sets the screen contrast. The low order two bits of the contrast value are ignored. The initial contrast value is 128 (\$80).

**Procedure** `RampContrast` (contrast: ScreenContrast);

A sudden change in the contrast level can be jarring to the user. `RampContrast` gradually changes the contrast to the new setting over a period of about a second. `RampContrast` returns immediately, then ramps the contrast using interrupt driven processing.

#### F.3.2 Automatic Screen Fading

**Function** `DimContrast`: ScreenContrast;

**Procedure** `SetDimContrast` (contrast: ScreenContrast);

The screen contrast level is automatically dimmed if no user activity is noted over a specified period (usually several minutes). This is done in order to preserve the screen phosphor. `DimContrast` returns the contrast value to which the screen is dimmed; `SetDimContrast` sets this value. The initial dim contrast setting is 176 (\$B0).

**Function FadeDelay: MilliSeconds;**

**Procedure SetFadeDelay (delay: MilliSeconds);**

The delay between the last user activity and dimming of the screen is under software control. **FadeDelay** returns the fade delay; **SetFadeDelay** sets it. The actual delay will range from the specified delay to twice the specified delay. The initial delay period is five minutes.

When the screen is dim, user interaction will cause the screen contrast to return to its normal bright level (determined by the **Contrast** and **SetContrast** routines defined above). Moving the mouse or pressing a key on the keyboard (e.g., **SHIFT**) is enough to trigger the screen brightening. Calling **CursorLocation** or **SetFadeDelay** also indicates user activity.

#### F.4 The Speaker

**Function Volume: SpeakerVolume;**

**Procedure SetVolume (volume: SpeakerVolume);**

**Procedure Noise (waveLength: MicroSeconds);**

**Procedure Silence;**

**Procedure Beep (waveLength: MicroSeconds; duration: MilliSeconds);**

The routines in this section provide square wave output from the Lisa speaker. The speaker volume can be set to values in the range 0 (soft) to 7 (loud). **Volume** reads the volume setting; **SetVolume** sets it. The initial volume setting is 4.

**Noise** produces a square wave of approximately the specified wavelength. **Silence** shuts off the square wave. The minimum wavelength is about 8 microseconds, which corresponds to a frequency of 125,000 cycles per second, well above the audible range. The maximum wavelength is 8,191 microseconds, which corresponds to about 122 cycles per second.

**Noise** and **Silence** are called in pairs to start and stop square wave output. In contrast, **Beep** starts square wave output which will automatically stop after the specified period of time. The effects of **Noise**, **Silence** and **Beep** are overridden by subsequent calls.

#### F.5 The Keyboard

The routines in this section provide an interface to the keyboard, the keypad, the mouse button and plug, the diskette buttons and insertion switches, and the power switch. Two interfaces are provided, a pollable keyboard state and a queue of keyboard events.

Three physical keyboard layouts are defined, the "Old US Layout" (with 73 keys on the main keyboard and numeric keypad), the "Final US Layout" (76 keys) and the "European Layout" (77 keys). Each key has been assigned a *keycode*, which uniquely identifies the key. Keycode values range from 0 to



127. Table F-1 defines the keycodes for the "Final US Layout", using the legends from the US Keyboard. The "Old US Layout" has three less keys; \, Alpha Enter, and Right Option are not on the old keyboard. The "European Layout" has one additional key, ><, with a keycode of \$43.

Two keys on the "Old US Layout" generate keycodes different from the corresponding keys on the "Final US Layout". To aid in compatibility, software changes the keycode for ~ from \$7C to \$68, and the keycode for Right Option from \$68 to \$4E.

Table F-1  
Keycodes for "Final US Layout"

HIGH-LOW ↕	000 0	001 1	010 2	011 3	100 4	101 5	110 6	111 7
0000 0			CLEAR		- _	( 9	E	A
0001 1	DISK 1 INSERTED		-		+ =	) 0	^ 6	@ 2
0010 2	DISK 1 BUTTON		+ 		 \	U	& 7	# 3
0011 3	DISK 2 INSERTED		* 			I	* 8	\$ 4
0100 4	DISK 2 BUTTON		7		P	J	% 5	! 1
0101 5	PARALLEL PORT		8		BACKSPACE	K	R	Q
0110 6	MOUSE BUTTON		9		ALPHA ENTER	{ [	T	S
0111 7	MOUSE PLUG		/ 			} ]	Y	W
1000 8	POWER BUTTON		4		RETURN	M	~ ,	TAB
1001 9			5		O	L	F	Z
1010 A			6			: ;	G	X
1011 B			/ 			" '	H	D
1100 C			.		? /	SPACE	V	LEFT OPTION
1101 D			2		1	< ,	C	CAPS LOCK
1110 E			3		RIGHT OPTION	> .	B	SHIFT
1111 F			NUMERIC ENTER			O	N	

## F.5.1 Keyboard Identification

Function Keyboard: KeybId;

Function Legends: KeybId;

Procedure SetLegends (Id: KeybId);

Lisa software supports a host of different keyboards. Each keyboard has three major attributes: manufacturer, physical *layout*, and *legends*. The chart below describes how these three attributes are combined to form a keyboard identification number. The keyboards self identify when the machine is turned on and when a new keyboard is attached. **Keyboard** returns the identification number of the keyboard currently attached. **Legends** and **SetLegends** provide a means of pretending to have different legends, without physically replacing the keyboard.

Keyboard identification numbers:

7	6	5	4	3	2	1	0
Manufacturer			Layout		Legends		

**Manufacturer:**

00 -- APD (i.e., TKC)  
 01 --  
 10 -- Keytronics

**Layout:**

00 -- Old US (73 keys)  
 01 --  
 10 -- European (77 keys)  
 11 -- Final US (76 keys)

**Layout/Legends:**

\$0F -- Old US  
 \$26 -- Swiss-German (allocated for proposed software)  
 \$27 -- Swiss-French (allocated for proposed software)  
 \$29 -- Portuguese (allocated for proposed software)  
 \$29 -- Spanish-Latin American (allocated for proposed software)  
 \$2A -- Danish (allocated for proposed software)  
 \$2B -- Swedish (hardware not yet available)  
 \$2C -- Italian (hardware not yet available)  
 \$2D -- French  
 \$2E -- German  
 \$2F -- UK

\$3C --	APL	(allocated for proposed software)
\$3D --	French-Canadian	(allocated for proposed software)
\$3E --	US-Dvorak	(allocated for proposed software)
\$3F --	Final US	

### F.5.2 Keyboard State

**Function** `KeyIsDown` (**key**: `KeyCap`): **Boolean**;

**Procedure** `KeyMap` (**var** `keys`: `KeyCapSet`);

Low level access to the keyboard is provided through a pollable keyboard state. This state information is based on the physical keycodes defined above. `KeyIsDown` returns the position of a single specified key. `KeyMap` returns a 128-bit map, one bit for each key. A zero indicates the key is up, a one indicates down. For the mouse plug, a zero indicates unplugged, a one indicates plugged in. Certain keys are not pollable; the corresponding bits will always be zero. These keys are the diskette insertion switches and buttons, parallel port, and power switch. (The parallel port and mouse plug keys are unreliable across reboots on older hardware.)

### F.5.3 Keyboard Events

The hardware interface provides a queue of keyboard events. The events in the input queue are generally key down transitions. Each event contains the following information:

<code>keycode</code>	--	physical key
<code>ascii</code>	--	ASCII interpretation of this key
<code>state</code>	--	caps-lock, shift, option,  , mouse button and repeat
<code>mouseX</code>	--	X-coordinate of the mouse when the key was pressed
<code>mouseY</code>	--	Y-coordinate of the mouse when the key was pressed
<code>time</code>	--	value of the millisecond timer when the key was pressed

**Keycode** -- Keycodes are defined in Table F-1, above.

**Ascii** -- The ASCII interpretation of keys depends on the state of the caps-lock, shift and option keys. Six interpretations are associated with each different keyboard layout:

```

normal
caps-lock
shift or both shift and caps-lock

option
option with caps-lock
option with shift or both shift and caps-lock

```

In most cases the ASCII value returned is obvious. The table below lists the cases that aren't so obvious.

\$00 (NUL)	Disk 1 Inserted
\$00 (NUL)	Disk 1 Button
\$00 (NUL)	Disk 2 Inserted
\$00 (NUL)	Disk 1 Button
\$00 (NUL)	Power Button
\$00 (NUL)	Mouse Button (down)
\$00 (NUL)	Mouse Plug (in)
\$01 (SOH)	Mouse Button (up)
\$01 (SOH)	Mouse Plug (out)
\$03 (ETX)	Enter
\$08 (BS)	BackSpace
\$09 (HT)	Tab
\$0D (CR)	Return
\$1B (ESC)	Clear
\$1C (FS)	Left
\$1D (GS)	Right
\$1E (RS)	Up
\$1F (US)	Down
\$20 (SP)	Space

**State** -- A 16-bit word is used to return the state of several keys with each event. Each bit represents one or more keys; a zero indicates that all of the keys are up, a one indicates that at least one of the keys is down. An additional bit indicates, if it is a one, that the event was generated by repeating the previous event. The following bits of state are currently assigned:

bit 0:	caps-lock
bit 1:	left or right shift
bit 2:	left or right option
bit 3:	⌘ key
bit 4:	mouse button
bit 5:	this event is a repeat

Certain keys never generate events. These keys are caps-lock, both shift keys, option keys, and the ⌘ key. The mouse button generates events on both the down and up transitions. Down transitions have an ascii value of 0, up transitions 1. The mouse plug also generates two different events. When the mouse is plugged in an event with an ascii value of 0 is returned, when it is unplugged a value of 1 is returned.

**Function KeybdPeek** (repeats: Boolean; index: KeybdQIndex; var event: KeyEvent): Boolean;

**KeybdPeek** is used to examine events in the keyboard queue, without removing them from the queue. The first input parameter indicates whether repeats are desired. The second parameter is the queue index. The first output parameter indicates whether the specified queue entry contains an event. To examine an entire queue, first call **KeybdPeek** with a queue index of 1. If an event is returned, call it again with a queue index of 2, etc.

**Function KeybdEvent** (repeats: Boolean; wait: Boolean; var event: KeyEvent): Boolean;

**KeybdEvent** is used both to determine if a keyboard event is available, and to return the event if one is available. The event is removed from the queue. **KeybdEvent** returns a boolean result which is true if an event is returned. The first parameter to **KeybdEvent** is used to indicate if the caller will accept repeated events on this call. The second parameter indicates if the functions should wait for an event if one is not immediately available.

#### F.5.4 Dead Key Diacriticals

Many languages employ diacritical marks on certain letters. Several of the required diacritical mark-letter combinations appear on European keyboards, but others do not. The combinations shown in the table below may be typed as a two-key sequence, by first typing the dead key diacritical (which has no immediate effect), and then typing the letter. Dead key diacriticals appear on keyboard legends as the diacritical mark over a dotted square or hollow box.

circumflex	^	--	â	ê	î	ô	û
grave accent	`	--	à	è	ì	ò	ù
tilde	~	--	ã		ñ	õ	
acute accent	´	--	á	é	í	ó	ú
umlaut	¨	--	ä	ë	ï	ö	ü

A dead key diacritical followed by a letter which appears in the table above yields the corresponding character. The event that is generated contains the keycode, state, mouse location and time that correspond to the letter, but the ASCII value of the letter-diacritical combination. A dead key diacritical followed by a space yields just the diacritical mark. The event contains the keycode, state, mouse location and time corresponding to the space, but the ASCII value of the diacritical mark. Finally, a dead key diacritical followed by any other character (i.e., not a space or defined letter) yields the diacritical mark followed by the other character.

diacritical, defined letter	-->	foreign character
diacritical, space	-->	diacritical
diacritical, other character	-->	diacritical, other character

**F.5.5 Repeats**

Most keys, if held down for an extended period of time, may generate multiple events (repeats). The keys that are *not* repeatable are caps-lock, both shifts, both options, the  $\text{\textcircled{C}}$  key, the diskette insertion switches and diskette buttons, parallel port, the mouse button and plug, and the power button. Several conditions must be satisfied before a repeat is generated. These conditions are as follows:

1. `KeybdPeek` or `KeybdEvent` is called with `repeatsDesired` true.
2. The keyboard event queue is empty.
3. The key returned in the last event is still down.
4. No down transitions have occurred since the last event.
5. The key is repeatable.
6. Enough time has elapsed.

Repeats generate events with the following attributes:

<code>keycode</code>	--	original keycode
<code>ascii</code>	--	original ASCII interpretation
<code>state</code>	--	original position of the caps-lock, shift, etc.
<code>mouseX</code>	--	revised X-coordinate of the mouse
<code>mouseY</code>	--	revised Y-coordinate of the mouse
<code>time</code>	--	revised value of the millisecond timer

**Procedure RepeatRate (var initial: Milliseconds; var subsequent: Milliseconds);**

**Procedure SetRepeatRate (initial: Milliseconds; subsequent: Milliseconds);**

The repeat rates can be read and set by calls to `RepeatRate` and `SetRepeatRate`. The rates include an initial delay, which occurs prior to the first repetition, and a subsequent delay, prior to additional repetitions. They are both in units of milliseconds. The default repeat rates are 400 milliseconds initially and 100 milliseconds subsequently.

**F.6 The Microsecond Timer**

**Function MicroTimer: Microseconds;**

The `MicroTimer` function simulates a continuously running 32-bit counter which is incremented every microsecond. The timer is reset to 0 each time the machine is booted. The timer changes sign about once every 35 minutes, and rolls over about every 70 minutes.

The microsecond timer is designed for performance measurements. It has a resolution of 2 microseconds. Calling `MicroTimer` from Pascal takes about 135 microseconds. Note that interrupt processing will have a major effect on microsecond timings.

### F.7 The Millisecond Timer

**Function** Timer: Milliseconds;

The Timer function simulates a continuously running 32-bit counter which is incremented every millisecond. The timer is reset to 0 each time the machine is booted. The timer changes sign about once every 25 days, and rolls over about every 7 weeks.

The millisecond timer is designed for timing user interactions such as mouse clicks and repeat keys. It can also be used for performance measurements, assuming that millisecond resolution is sufficient.

### F.8 Date and Time

**Procedure** DateTime (var date: DateArray);

**Procedure** SetDateTime (date: DateArray);

**Procedure** DateToTime (date: DateArray; var time: Seconds);

The current date and time are available as a set of 16-bit integers which represent the year, day, hour, minute and second, by calling `DateTime` and `SetDateTime`. The date and time are based on the hardware clock/calendar. This restricts dates to the years 1980-1995. The clock/calendar continues to operate during soft power off, and for brief periods on battery backup if the machine is unplugged. If the clock/calendar hasn't been set since the last loss of battery power, the date and time will be midnight prior to January 1, 1980. Setting the date and time also sets the time stamp described below. `DateToTime` converts a date and time to a time stamp, defined in the next section.

### F.9 Time Stamp

**Function** TimeStamp: Seconds;

**Procedure** SetTimeStamp (time: Seconds);

**Procedure** TimeToDate (time: Seconds; var date: DateArray);

The current date and time are also available as a 32-bit unsigned integer which represents the number of seconds since the midnight prior to 1 January 1901, by calling `TimeStamp` and `SetTimeStamp`. The time stamp will roll over once every 135 years. Beware--for dates beyond the mid 1960's, the sign bit is set. The time stamp is based on the hardware clock/calendar. This clock continues to operate during soft power off, and for brief periods on battery backup if the machine is unplugged. If the clock/calendar hasn't been set since the last loss of battery power, the date and time will be midnight prior to January 1, 1980. Setting the time stamp also sets the date and time described above. Since the date and time is restricted to 1980-1995, the time stamp is also restricted to this range. `TimeToDate` converts a time stamp to the date and time format defined above.

## F.10 Interface of the Hardware Unit

```
Unit Hardware;
```

```
Interface
```

```
type
```

```

    Pixels           = Integer;
    ManyPixels      = LongInt;
    CursorHeight     = Integer;
    CursorPtr        = ^Integer;
    DateArray        = Record
        year: Integer;
        day: Integer;
        hour: Integer;
        minute: Integer;
        second: Integer;
    end;
    Frames           = LongInt;
    Seconds          = LongInt;
    MilliSeconds     = LongInt;
    MicroSeconds     = LongInt;
    SpeakerVolume    = Integer;
    ScreenContrast   = Integer;
    KeybdQIndex      = 1..1000;
    KeybdId          = Integer;
    KeyCap           = 0..127;
    KeyCapSet        = Set of KeyCap;
    KeyEvent         = Packed Record
        key: KeyCap;
        ascii: Char;
        state: Integer;
        mouseX: Pixels;
        mouseY: Pixels;
        time: MilliSeconds;
    end;

```

```
{ Mouse }
```

```

    Procedure MouseLocation (var x: Pixels; var y: Pixels);
    Procedure MouseUpdates (delay: MilliSeconds);
    Procedure MouseScaling (scale: Boolean);
    Procedure MouseThresh (threshold: Pixels);
    Function MouseOdometer: ManyPixels;

```



{ Cursor }

```
Procedure CursorLocation (x: Pixels; y: Pixels);
Procedure CursorTracking (track: Boolean);
Procedure CursorImage (hotX: Pixels; hotY: Pixels; height:
  CursorHeight; data: CursorPtr; mask: CursorPtr);

Procedure BusyImage (hotX: Pixels; hotY: Pixels; height:
  CursorHeight; data: CursorPtr; mask: CursorPtr);
Procedure BusyDelay (delay: MilliSeconds);
```

{ Screen }

```
Function FrameCounter: Frames;
Procedure ScreenSize (var x: Pixels; var y: Pixels);

Function Contrast: ScreenContrast;
Procedure SetContrast (contrast: ScreenContrast);
Procedure RampContrast (contrast: ScreenContrast);
Function DimContrast: ScreenContrast;
Procedure SetDimContrast (contrast: ScreenContrast);

Function FadeDelay: MilliSeconds;
Procedure SetFadeDelay (delay: MilliSeconds);
```

{ Speaker }

```
Function Volume: SpeakerVolume;
Procedure SetVolume (volume: SpeakerVolume);
Procedure Noise (waveLength: MicroSeconds);
Procedure Silence;
Procedure Beep (waveLength: MicroSeconds; duration: MilliSeconds);
```

{ Keyboard }

```
Function Keyboard: KeybdId;
Function Legends: KeybdId;
Procedure SetLegends (id: KeybdId);
Function KeyIsDown (key: KeyCap): Boolean;
Procedure KeyMap (var keys: KeyCapSet);
Function KeybdPeek (repeats: Boolean; index: KeybdQIndex; var
    event: KeyEvent): Boolean;
Function KeybdEvent (repeats: Boolean; wait: Boolean; var event:
    KeyEvent): Boolean;
Procedure RepeatRate (var initial: MilliSeconds; var subsequent:
    MilliSeconds);
Procedure SetRepeatRate (initial: MilliSeconds; subsequent:
    MilliSeconds);
```

{ Timers }

```
Function MicroTimer: MicroSeconds;
Function Timer: MilliSeconds;
```

{ Date and Time }

```
Procedure DateTime (var date: DateArray);
Procedure SetDateTime (date: DateArray);
Procedure DateToTime (date: DateArray; var time: Seconds);
```

{ Time Stamp }

```
Function TimeStamp: Seconds;
Procedure SetTimeStamp (time: Seconds);
Procedure TimeToDate (time: Seconds; var date: DateArray);
```



## Appendix G

### Lisa Extended Character Set

	0	1	2	3	4	5	6	7	8	9	A	B	C	D	E	F
0	NUL	DLE	SP	0	@	P	`	p	Ä	ê	†	∞	¿	-		
1	SOH	DC1	!	1	A	Q	a	q	Å	ë	°	±	i	—		
2	STX	DC2	"	2	B	R	b	r	Ç	í	¢	≤	¬	"		
3	ETX	DC3	#	3	C	S	c	s	É	ì	£	≥	√	"		
4	EOT	DC4	\$	4	D	T	d	t	Ñ	î	§	¥	f	'		
5	ENQ	NAK	%	5	E	U	e	u	Ö	ï	•	μ	≈	'		
6	ACK	SYN	&	6	F	V	f	v	Ü	ñ	¶	ð	Δ	÷		
7	DEL	ETB	'	7	G	W	g	w	á	ó	ß	Σ	«	◇		
8	BS	CAN	(	8	H	X	h	x	à	ò	®	Π	»	ÿ		
9	HT	EH	)	9	I	Y	i	y	â	ô	©	π	...			
A	LF	SUB	*	:	J	Z	j	z	ä	ö	™	¡	¸			
B	VT	ESC	+	;	K	[	k	{	ã	õ	´	¸	À			
C	FF	FS	,	<	L	\	l		å	ú	¨	º	Ã			
D	CR	GS	—	=	M	]	m	}	ç	ù	≠	Ω	Ö			
E	SO	RS	.	>	N	ˆ	n	˜	é	û	Æ	æ	Œ			
F	SI	US	/	?	O	_	o	DEL	è	ü	Ø	ø	œ			

The first 32 characters and DEL are nonprinting control codes.  
 The shaded area is reserved for future use.



# Appendix H

## Error Messages

H.1 Error Reporting .....	H-1
H.2 Lexical Errors .....	H-1
H.3 Syntactic Errors .....	H-2
H.4 Semantic Errors .....	H-2
H.5 Conditional Compilation .....	H-5
H.6 Compiler Specific Limitations .....	H-5
H.7 I/O Errors .....	H-5
H.8 Clascal Errors .....	H-5
H.9 Code Generation Errors .....	H-6
H.10 Verification Errors .....	H-6



# Error Messages

## H.1 Error Reporting

Error reports show the entire line containing an error. Error lines displayed on the screen and written to the error listing file (\$E Compiler command) usually show the line preceding the error for context, too, although there are some circumstances in which that line is not shown.

```
12          Read(Argument)
13          IF (IOResut<=0) AND (Arg>=0) THEN
?
*** Error 36 *** ';' expected.
?
?
*** Error 102 *** Identifier not declared.
*** File example/errors.TEXT ***
```

Errors for any one line are accumulated (up to a maximum of 10) and reported after the line is fully scanned. Both the error number and its associated text are shown along with a "?" pointer to the error's approximate location. The pointer usually points to the last character of the token that was being processed when the error occurred. The pointer for an error message is shown on the line before the message. There may be multiple pointers associated with a single message, or multiple messages associated with a single pointer. The source line is shown only once. The line number preceding it is the line position within the file whose name is shown as the last line in the error report. That line number may be used in conjunction with the Editor's "Goto line #" feature to quickly find the errors in the specified file.

## H.2 Lexical Errors

- 10 Too many digits
- 11 Digit expected after '.' in real
- 12 Integer overflow
- 13 Digit expected in exponent
- 14 End of line encountered in string constant
- 15 Illegal character in input
- 16 Premature end of file in source program
- 17 Extra characters encountered after end of program
- 18 End of file encountered in a comment



**H.3 Syntactic Errors**

- 20 Illegal symbol
- 21 Error in simple type
- 22 Error in declaration part
- 23 Error in parameter list
- 24 Error in constant
- 25 Error in type
- 26 Error in field list
- 27 Error in factor
- 28 Error in variable
- 29 Identifier expected
- 30 Integer expected
- 31 '(' expected
- 32 ')' expected
- 33 '[' expected
- 34 ']' expected
- 35 ':' expected
- 36 ';' expected
- 37 '=' expected
- 38 '.' expected
- 39 '\*' expected
- 40 ':=' expected
- 41 'program' expected
- 42 'of' expected
- 43 'begin' expected
- 44 'end' expected
- 45 'then' expected
- 46 'until' expected
- 47 'do' expected
- 48 'to' or 'downto' expected
- 49 'file' expected
- 50 'if' expected
- 51 '.' expected
- 52 'implementation' expected
- 53 'interface' expected
- 54 'intrinsic' expected
- 55 'shared' expected
- 56 A '.' or '(' is expected following a type-id

**H.4 Semantic Errors**

- 100 Identifier declared twice
- 101 Identifier not of the appropriate class
- 102 Identifier not declared
- 103 Sign not allowed
- 104 Number expected
- 105 Lower bound exceeds upper bound
- 106 Incompatible subrange types

- 107 Type of constant must be integer
- 108 Type must not be real
- 109 Tagfield must be scalar or subrange
- 110 Type incompatible with with tagfield type
- 111 Index type must not be real
- 112 Index type must be scalar or subrange
- 113 Index type must not be integer or longint
- 114 Unsatisfied forward reference for type identifier:
- 115 Illegal use of forward reference type identifier
- 116 Parameter list is inconsistent with original specification
- 117 Function result type is inconsistent with original specification
- 118 Function result type must be scalar, subrange, or pointer
- 119 File value parameter not allowed
- 120 Missing result type in function declaration
- 121 F-format for real only
- 122 Error in type of standard function parameter
- 123 Error in type of standard procedure parameter
- 124 Number of parameters does not agree with declaration
- 125 Illegal parameter substitution
- 126 Result type of parameteric function does not agree with declaration
- 127 Expression is not of set type
- 128 Only tests on equality allowed
- 129 Strict inclusion not allowed
- 130 File comparison not allowed
- 131 Illegal type of operand(s)
- 132 Type of operand must be boolean
- 133 Set element type must be scalar or subrange
- 134 Set element types not compatible
- 135 Type of variable is not array or string
- 136 Index type is not compatible with declaration
- 137 Type of variable is not record
- 138 Type of variable must be file or pointer
- 139 Illegal type of loop control variable
- 140 Illegal type of expression
- 141 Assignment of files not allowed
- 142 Label type incompatible with selecting expression
- 143 Subrange bounds must be scalar
- 144 Type conflict of operands
- 145 Assignment to standard function is not allowed
- 146 Assignment to formal function is not allowed
- 147 No such field in this record
- 148 Type error in read
- 149 Actual parameter must be a variable
- 150 Multidefined case label
- 151 Missing corresponding variant declaration

- 152 Real or string tagfields not allowed
- 153 Previous declaration was not forward
- 154 Substitution of standard procedure or function is not allowed
- 155 Multidefined label
- 156 Multideclared label
- 157 Undefined label:
- 158 Undeclared label
- 159 Value parameter expected
- 160 Multidefined record variant
- 161 File not allowed here
- 162 Unknown compiler directive (not 'external', 'forward', 'inline', or 'c')
- 163 Variable cannot be packed field
- 164 Set of real is not allowed
- 165 Fields of packed records cannot be var parameters
- 166 Case selector expression must be scalar or subrange
- 167 String sizes must be equal
- 168 String too long
- 169 Value out of range
- 170 Address of standard procedure cannot be taken
- 171 Assignment to function result must be done inside function
- 172 Loop control variable must be local
- 173 Label value must be in 0..9999
- 174 Must exit to an enclosing procedure
- 175 Procedure or function has already been declared once
- 176 Unsatisfied forward declaration for Procedure
- 177 Unsatisfied forward declaration for Function
- 178 Type conversion to a different size type is not allowed
- 179 Illegal type of operands in constant expression
- 180 Division by 0
- 181 NIL is not allowed in a constant expression
- 182 @ is not allowed in a constant expression
- 183 Only certain pre-defined functions are allowed here
- 184 Dereferencing is not allowed here
- 185 INLINE code constants must be single word integers
- 186 INLINE not allowed because procedure/function is already declared
- 190 No such unit in this file

**H.5 Conditional Compilation**

- 260 New compile-time variable must be declared at global level
- 261 Undefined compile-time variable
- 262 Error in compile-time expression
- 263 Conditional compilation options nested too deeply
- 264 Unmatched ELSEC
- 265 Unmatched ENDC
- 266 Error in SETC
- 267 Unterminated conditional compilation option

**H.6 Compiler Specific Limitations**

- 300 Too many nested record scopes
- 301 Set limits out of range
- 302 String limits out of range
- 303 Too many nested procedures/functions
- 304 Too many nested include/uses files
- 305 Includes not allowed in interface section
- 306 Pack and unpack are not implemented
- 307 Too many units
- 308 Set constant out of range
- 309 Structure too large ( > 32K )
- 310 Parameter list too large ( >= 32K )
- 312 Size of local data is too large ( > 32K )
- 313 Size of global data is too large ( > 32K )
- 350 Procedure too large
- 351 File name in option too long
- 352 Too many errors on this line

**H.7 I/O Errors**

- 400 Not enough room for code file
- 401 Error in rereading code file
- 402 Error in reopening text file
- 403 Unable to open uses file
- 404 Error in reading uses file
- 405 Error in opening include file - compilation terminated
- 406 Error in rereading previously read text block
- 407 Not enough room for I-code file
- 408 Error in writing code file
- 409 Error in reading I-code file
- 410 Unable to open listing file
- 420 I/O error on debug file

**H.8 Clascal Errors**

- 800 OF missing
- 801 Superclass identifier missing
- 802 Method NEW is not declared
- 803 Subclass declaration not allowed here
- 804 Method is not a procedure

- 805 Unimplemented method:
- 806 Unimplemented class:
- 807 Superclass identifier is not a class
- 808 Identifier is not a class
- 809 'NEW' not allowed here
- 810 'NEW' was expected here
- 811 Illegal 'NEW' method
- 812 Illegal use of class identifier
- 813 Unsafe use of a handle in an assignment statement
- 814 Unsafe use of a handle in a WITH statement
- 815 Unsafe use of a handle as a var parameter
- 817 Compiler error!!!
- 818 Override of non-existent procedure or function
- 819 ThisClass function is only legal in methods

**H.9 Code Generation Errors**

- 1000-1999 Internal code generation errors
- 2000 End of I-code file not found
- 2001 Expression too complicated, code generator ran out of registers
- 2002 Code generator tried to free a register that was already free
- 2003-2005 Error in generating address
- 2006-2010 Error in expressions
- 2011 Too many globals
- 2012 Too many locals

**H.10 Verification Errors**

- 4000 Bad verification block format
- 4001 Source code version conflict
- 4002 Compiler version conflict
- 4003 Linker version conflict
- 4100 Version in file less than minimum version supported by program
- 4101 Version in file greater than maximum version supported by program

# Appendix I

## Pascal Workshop Files

This appendix lists the files provided on the Pascal 3.0 micro diskettes, first alphabetically, then by diskette.

File Name	Pascal		Description
	Diskette	Notes	
Alert	9	E	QuickPort support file
apin/syslib.obj	1		A Intrinsic unit-misc.
Archiver.Obj	7		Utility program
Assembler.Obj	5	C	Workshop program-68000 Assembler
ByteDiff.Obj	7		Utility program
ChangeSeg.Obj	7		Utility program
CharCount.Obj	7		Utility program
Code.Obj	5	C	Workshop program-Pascal Code Generator
CodeSize.Obj	7		Utility program
Comp.Text	7		Utility program
Compare.Help.Text	7		Support file-Compare
Compare.Obj	7		Utility program
Concat.Obj	7		Utility program
Copy.Obj	7		Utility program
Diff.Obj	7		Utility program
DumpObj.Obj	7		Utility program
DumpPatch.Obj	7		Utility program
Edit.Menus.Text	5	C	Support file-Editor menus file
Editor.Obj	5	C	Workshop program-Editor
ErrTool.Obj	7		Utility program
FileDiv.Obj	7		Utility program
FileJoin.Obj	7		Utility program
Find.Obj	7		Utility program
FindID.Obj	7		Utility program

**Note A:** These files are used for the installation procedure but are not installed.

**Note B:** These files are the minimum necessary to run a user program in the Workshop environment. A user program may require other files as well.

**Note C:** These files are necessary for running the minimum Pascal Workshop (Editor, Assembler, Pascal Compiler and Code Generator, Linker, and Debugger).

**Note D:** These files are needed only for developing Macintosh software.

**Note E:** These files are needed only for developing Lisa QuickPort software.

**Note F:** These files are needed only by the Lisa Office System.

**Note G:** These files are needed only for developing Lisa QuickDraw software.

File Name	Pascal Diskette	Notes	Description
FindWord.Obj	7		Utility program
font.heur	1	A	Support file
font.heur	2	C	Support file
font.lib	1	A	Support file-tiny font library
font.lib	2	C	Support file-font library
gxref.Obj	7		Utility program
InstallTool.Obj	8	E	Utility program
installwsphrase	1	A	Support file
Intrinsic.Lib	1	A	Library directory-intrinsic units
Intrinsic.Lib	2	BC	Library directory-intrinsic units
IOSFPLIB.Obj	6	C	Intrinsic unit-floating point
iospaslib.obj	1	A	Intrinsic unit-Pascal support
iospaslib.obj	2	BC	Intrinsic unit-Pascal support
IUManager.Obj	3		Utility program
LIBTK/PABC.TEXT	9	E	QuickPort support file
LineCount.Obj	7		Utility program
Linker.Obj	6	C	Workshop program-Linker
LWCcount.Obj	7		Utility program
MAC/Mac.Boot	9	D	Support file-Mac boot code
MAC/MacCom.Obj	9	D	Utility program
MAC/RMaker.Obj	9	D	Utility program
N68K.ERR	5	C	Support file-Assembler
N68K.OPCODES	5	C	Support file-Assembler
ObjIOLib.Obj	4	C	Intrinsic unit-object files
OEMsyscall.Obj	6		Regular unit-privileged system calls
OSErrs.Err	5	C	Support file-error message text
paper.text	5	C	Support file-Editor stationery
Pascal.Obj	5	C	Workshop program-Pascal Compiler
PasErrs.Err	5	C	Support file-error message text
PasLibCall.Obj	6		Intrinsic unit-Pascal support
PasMat.Help.Text	7		Support file-Pasmat
PasMat.Obj	7		Utility program
PortConfig.Obj	4		Utility program
PRLib.Obj	6	F	Intrinsic unit-Printing

**Note A:** These files are used for the installation procedure but are not installed.

**Note B:** These files are the minimum necessary to run a user program in the Workshop environment. A user program may require other files as well.

**Note C:** These files are necessary for running the minimum Pascal Workshop (Editor, Assembler, Pascal Compiler and Code Generator, Linker, and Debugger).

**Note D:** These files are needed only for developing Macintosh software.

**Note E:** These files are needed only for developing Lisa QuickPort software.

**Note F:** These files are needed only by the Lisa Office System.

**Note G:** These files are needed only for developing Lisa QuickDraw software.

File Name	Pascal Diskette	Notes	Description
ProcNames.Help.Text	7		Support file-ProcNames
ProcNames.Obj	7		Utility program
QD/boxes.Obj	9	G	QuickDraw example program
QD/boxes.text	9	G	QuickDraw example source
QD/graf3d.Obj	9	G	Regular unit-3D graphics
QD/grafypes.text	9	G	QuickDraw assembly interfaces
QD/Hardware.Obj	9	G	Regular unit-hardware interfaces
QD/m/boxes.text	9	G	QuickDraw example exec file
QD/m/sample.text	9	G	QuickDraw example exec file
QD/sample.Obj	9	G	QuickDraw example program
QD/sample.text	9	G	QuickDraw example source
QD/support.Obj	9	G	Regular unit-QuickDraw support
QP/BOXES.LLIST.TEXT	9	E	QuickPort sample program
qp/boxes.text	9	E	QuickPort sample program
QP/Graf3D.Obj	9	E	Regular unit-3D graphics
QP/Hardware.Obj	9	E	Regular unit-hardware interface
qp/mainbaud.text	9	E	QuickPort sample program
QP/Make.Text	9	E	QuickPort exec file
qp/MBAUD.CONFIG.TEXT	9	E	QuickPort sample program
qp/MBAUD.VT100.TEXT	9	E	QuickPort sample program
qp/mouseinput.text	9	E	QuickPort sample program
qp/mouseinput2.TEXT	9	E	QuickPort sample program
QP/PHRASE	9	E	Support file-QuickPort
qp/phuser.text	9	E	QuickPort sample program
qp/QDSAMPLE.CONFIG.TEXT	9	E	QuickPort sample program
qp/qdsample.pic.TEXT	9	E	QuickPort sample program
qp/qdsample.text	9	E	QuickPort sample program
qp/ubaudrate.text	9	E	QuickPort sample program
QP/UQPortCall.Obj	9	E	Regular unit-QuickPort interfaces
QP/UQPortGraph.Obj	9	E	Regular unit-QuickPort interfaces
QP/UQPortSoroc.Obj	9	E	Regular unit-QuickPort interfaces
qp/uqportuser.TEXT	9	E	QuickPort sample program
QP/UQPortVT100.Obj	9	E	Regular unit-QuickPort interfaces
qp/uqpsupport.TEXT	9	E	QuickPort support file

**Note A:** These files are used for the installation procedure but are not installed.

**Note B:** These files are the minimum necessary to run a user program in the Workshop environment. A user program may require other files as well.

**Note C:** These files are necessary for running the minimum Pascal Workshop (Editor, Assembler, Pascal Compiler and Code Generator, Linker, and Debugger).

**Note D:** These files are needed only for developing Macintosh software.

**Note E:** These files are needed only for developing Lisa QuickPort software.

**Note F:** These files are needed only by the Lisa Office System.

**Note G:** These files are needed only for developing Lisa QuickDraw software.



File Name	Pascal Diskette	Notes	Description
QP/UQuickPort.Obj	9	E	Regular unit-QuickPort interfaces
qp/usertab.TEXT	9	E	QuickPort sample program
qp/userterm.text	9	E	QuickPort sample program
QPLib.Obj	9	E	Intrinsic unit-QuickPort
qpsample.note.text	9	E	QuickPort sample program notes
Search.Obj	7		Utility program
SegMap.Obj	7		Utility program
shell.Workshop	5	BC	Workshop shell
ShowInterface.Help.Text	7		Support file-ShowInterface
ShowInterface.Obj	7		Utility program
SJLib.Obj	4	BC	Intrinsic unit-standard units
SXref.Assembly.Text	7		Support file
SXref.Basic.Text	7		Support file
SXref.Obj	7		Utility program
SXref.Pascal.Text	7		Support file
Sys1Lib.Obj	4	BC	Intrinsic unit-misc.
Sys2Lib.Obj	6	EF	Intrinsic unit-misc.
SysCall.Obj	6		Intrinsic unit-OS interfaces
system.bt_Priam Disk	1	C	System support-Priam boot tracks
system.bt_Profile	1	C	System support-ProFile boot tracks
system.bt_Sony	2	C	System support-Sony boot tracks
system.cdd	1	BC	System support-configurable driver directory
system.cd_2 Port Card	1	C	System support-2-port card driver
system.cd_Archive Tape	1	C	System support-Archive tape driver
system.cd_Console	1	BC	System support-console driver
system.cd_Modem A	2	C	System support-Europe-modem A driver
system.cd_Parallel Cable	2	C	System support-parallel cable driver
system.cd_Priam Card	1	C	System support-Priam card driver
system.cd_Priam Disk	1	C	System support-Priam disk driver
system.cd_Profile	1	BC	System support-ProFile or internal hard disk driver
system.cd_Serial Cable	2	C	System support-USA-serial cable driver

**Note A:** These files are used for the installation procedure but are not installed.

**Note B:** These files are the minimum necessary to run a user program in the Workshop environment. A user program may require other files as well.

**Note C:** These files are necessary for running the minimum Pascal Workshop (Editor, Assembler, Pascal Compiler and Code Generator, Linker, and Debugger).

**Note D:** These files are needed only for developing Macintosh software.

**Note E:** These files are needed only for developing Lisa QuickPort software.

**Note F:** These files are needed only by the Lisa Office System.

**Note G:** These files are needed only for developing Lisa QuickDraw software.

File Name	Pascal Diskette	Notes	Description
system.cd_Sony	1	BC	System support-micro diskette driver
system.debug	3	C	System program-debugger
system.debug2	3	C	System program-debugger
system.lld	1	A	System program-low-level drivers
system.lld	2	BC	System program-low-level drivers
system.os	1	A	System program-OS
system.os	3	BC	System program-OS
SYSTEM.PROD	3	C	System support-print code configuration
System.PR_Daisy Wheel Printer	3	F	System support-daisy wheel printer
system.PR_Imagewriter /    DMP	3	F	System support-Imagewriter/DMP
System.PR_Ink Jet Printer	1	F	System support-ink jet printer
system.shell	1	A	Installation shell
system.shell	2	BC	Environments window
SYSTEM.UNPACK	1	BC	System support-unpack table
TK2LIB.Obj	8	E	Intrinsic unit-ToolKit
TKLIB.Obj	8	E	Intrinsic unit-ToolKit
Tools.Help.Text	7		Support file-various utilities
Transfer.Menus.Text	6		Support file-Transfer menus file
Transfer.Obj	6		Workshop program-Transfer program
Translit.Obj	7		Utility program
UXref.Obj	7		Utility program
WordCount.Obj	7		Utility program
Workshop.Step.Help.Text	5		Support file-Workshop shell
WORKSHOPERRS.ERR	5		Support file-error message text
xref.help.text	7		Support file-XRef
xref.Obj	7		Utility program
{T11}BUTTONS	3	C	Support file-Preferences
{T11}obj	3	C	Workshop program-Preferences
{T11}PHRASE	3	C	Support file-Preferences

**Note A:** These files are used for the installation procedure but are not installed.

**Note B:** These files are the minimum necessary to run a user program in the Workshop environment. A user program may require other files as well.

**Note C:** These files are necessary for running the minimum Pascal Workshop (Editor, Assembler, Pascal Compiler and Code Generator, Linker, and Debugger).

**Note D:** These files are needed only for developing Macintosh software.

**Note E:** These files are needed only for developing Lisa QuickPort software.

**Note F:** These files are needed only by the Lisa Office System.

**Note G:** These files are needed only for developing Lisa QuickDraw software.

**Pascal Diskette 1**

Filename	Size	Psize
apin/syslib.obj	89600	175
font.heur	1536	3
font.lib	5746	12
installwsphrase	17422	35
Intrinsic.Lib	1536	3
iospaslib.obj	24576	48
system.bt_Priam Disk	11264	22
system.bt_Profile	11776	23
system.cdd	1536	3
system.cd_2 Port Card	1024	2
system.cd_Archive Tape	4096	8
system.cd_Console	5120	10
system.cd_Priam Card	2048	4
system.cd_Priam Disk	3584	7
system.cd_Profile	5632	11
system.cd_Sony	3584	7
system.lld	10240	20
system.os	142848	279
system.shell	16896	33
SYSTEM.UNPACK	1024	2

707 total blocks for files listed

31 blocks of OS overhead for catalog and files listed

34 blocks free out of 772

**Pascal Diskette 2**

Filename	Size	Psize
font.heur	1536	3
font.lib	264070	516
Intrinsic.Lib	5120	10
iospaslib.obj	47616	93
system.bt_Sony	11776	23
system.cd_Modem A	8192	16
system.cd_Parallel Cable	2560	5
system.cd_Serial Cable	7168	14
system.lld	10240	20
system.shell	7680	15

715 total blocks for files listed

21 blocks of OS overhead for catalog and files listed

36 blocks free out of 772

**Pascal Diskette 3**

Filename	Size	Psize
IUManager.Obj	14336	28
system.debug	32768	64
system.debug2	16384	32
system.os	161792	316
SYSTEM.PRD	402	1
System.PR_Daisy Wheel P...	15872	31
system.PR_Imagewriter /...	17408	34
{T11}BUTTONS	43520	85
{T11}obj	31232	61
{T11}PHRASE	11215	22

674 total blocks for files listed

32 blocks of OS overhead for catalog and files listed

78 blocks free out of 772

**Pascal Diskette 4**

Filename	Size	Psize
ObjIOLib.Obj	59392	116
PortConfig.Obj	6144	12
SULib.Obj	27648	54
Sys1Lib.Obj	275968	539
System.PR_Ink Jet Print...	14336	28

749 total blocks for files listed

27 blocks of OS overhead for catalog and files listed

8 blocks free out of 772

**Pascal Diskette 5**

Filename	Size	Psize
Assembler.Obj	42496	83
Code.Obj	51712	101
Edit.Menus.Text	3072	6
Editor.Obj	40960	80
N68K.ERR	3072	6
N68K.OPCODES	4096	8
OSErrs.Err	22528	44
paper.text	2048	4
Pascal.Obj	116736	228
PasErrs.Err	7680	15
shell.Workshop	76800	150
Workshop.Step.Help.Text	2048	4
WORKSHOPERRS.ERR	2048	4

733 total blocks for files listed

35 blocks of OS overhead for catalog and files listed

16 blocks free out of 772

**Pascal Diskette 6**

Filename	Size	Psize
IOSFPLIB.Obj	66048	129
Linker.Obj	37888	74
OEMsyscall.Obj	4608	9
PasLibCall.Obj	2560	5
PRLib.Obj	43520	85
Sys2Lib.Obj	134656	263
SysCall.Obj	22016	43
Transfer.Menus.Text	2048	4
Transfer.Obj	14336	28

640 total blocks for files listed

30 blocks of OS overhead for catalog and files listed

114 blocks free out of 772

## Pascal Diskette 7

Filename	Size	Psize
Archiver.Obj	12288	24
ByteDiff.Obj	2560	5
ChangeSeg.Obj	2560	5
CharCount.Obj	5120	10
CodeSize.Obj	8704	17
Comp.Text	2048	4
Compare.Help.Text	7168	14
Compare.Obj	12800	25
Concat.Obj	5120	10
Copy.Obj	6144	12
Diff.Obj	9216	18
DumpObj.Obj	22016	43
DumpPatch.Obj	8192	16
ErrTool.Obj	3072	6
FileDiv.Obj	4608	9
FileJoin.Obj	3584	7
Find.Obj	8192	16
FindID.Obj	2560	5
FindWord.Obj	1536	3
gxref.Obj	14848	29
LineCount.Obj	5120	10
LWCcount.Obj	5120	10
PasMat.Help.Text	11264	22
PasMat.Obj	37376	73
ProcNames.Help.Text	5120	10
ProcNames.Obj	19968	39
Search.Obj	8192	16
SegMap.Obj	2560	5
ShowInterface.Help.Text	4096	8
ShowInterface.Obj	29696	58
SXref.Assembly.Text	3072	6
SXref.Basic.Text	3072	6
SXref.Obj	15360	30
SXref.Pascal.Text	2048	4
Tools.Help.Text	8192	16
Translit.Obj	7168	14
UXref.Obj	14336	28
WordCount.Obj	5120	10
xref.help.text	5120	10
xref.Obj	25600	50

703 total blocks for files listed

70 blocks of OS overhead for catalog and files listed

11 blocks free out of 772

**Pascal Diskette 8**

Filename	Size	Psize
InstallTool.Obj	14336	28
TK2LIB.Obj	155136	303
TKLIB.Obj	174592	341

672 total blocks for files listed

25 blocks of OS overhead for catalog and files listed

87 blocks free out of 772

**Pascal Diskette 9**

Filename	Size	Psize
ALERT	18432	36
LIBTK/PABC.TEXT	11264	22
MAC/Mac.Boot	2560	5
MAC/MacCom.Obj	20992	41
MAC/RMaker.Obj	24576	48
QD/boxes.Obj	7680	15
QD/boxes.text	6144	12
QD/graf3d.Obj	10752	21
QD/grafatypes.text	14336	28
QD/Hardware.Obj	4608	9
QD/m/boxes.text	2048	4
QD/m/sample.text	2048	4
QD/sample.Obj	7680	15
QD/sample.text	12288	24
QD/support.Obj	3072	6
QP/BOXES.LLIST.TEXT	2048	4
qp/boxes.text	6144	12
QP/Graf3D.Obj	10752	21
QP/Hardware.Obj	3584	7
qp/mainbaud.text	2048	4
QP/Make.Text	5120	10
qp/MBAUD.CONFIG.TEXT	3072	6
qp/MBAUD.VT100.TEXT	2048	4
qp/mouseinput.text	7168	14
qp/mouseinput2.TEXT	8192	16
QP/PHRASE	7288	15
qp/phuser.text	4096	8
qp/QDSAMPLE.CONFIG.TEXT	14336	28
qp/qdsample.pic.TEXT	13312	26
qp/qdsample.text	13312	26
qp/ubaudrate.text	3072	6

QP/UQPortCall.Obj	6656	13
QP/UQPortGraph.Obj	1536	3
QP/UQPortSoroc.Obj	1536	3
qp/uqportuser.TEXT	2048	4
QP/UQPortVT100.Obj	1536	3
qp/uqpsupport.TEXT	3072	6
QP/UQuickPort.Obj	1536	3
qp/usertab.TEXT	2048	4
qp/userterm.text	3072	6
QPlib.Obj	60416	118
qpsemple.note.text	3072	6

666 total blocks for files listed

72 blocks of OS overhead for catalog and files listed

46 blocks free out of 772





## Appendix J

# Listing Formats

Six different listing formats can be generated by the Compiler and Code Generator, allowing you to show different amounts of generated assembly code and other information intermixed with your Pascal source. All the listings show the total line number count and the line number within each **include** file, plus lexical information. An example of each of the listing formats is shown at the end of this appendix. The Compiler commands and Compiler and Code Generator options that control the listing are described in the Release 3.0 Notes to Chapter 12.

The six different listing formats are:

1. A *basic listing* as produced by the Compiler. The other five listing formats are modifications of this basic format. Unless you specify **\$L-** as an option to the Code Generator, you won't see this listing, because its presence is a signal to the Code Generator that it should modify the listing to one of the other five formats (its name is passed in the I-code).

In the basic listing, each line of the source is preceded by five fields of information:

Field 1: The total line count.

Field 2: The current **include** and **uses** nesting depth. If the input is not from either a **uses** or **include**, this field will be blank.

Field 3: The line number of each line with respect to the **include** file containing that line. All error references are reported in terms of this line number. You may use it in conjunction with the Editor's "Goto line #" feature to easily locate the lines that contain the reported errors.

Field 4: This field consists of two indicators (left and right) that reflect the static block nesting level. The left indicator is incremented (mod 10) and displayed whenever a **begin**, **repeat**, or **case** is encountered. On termination of these structures with an **end** or **until**, the right indicator is displayed and then decremented. It is thus easy to match **begin**, **repeat**, and **case** statements with their matching terminations.

Field 5: A letter in the this field reflects the static level of procedures and functions. The character is updated for each procedure or function nest level ("A" for level 1, "B" for level 2, and so on), and displayed on the line containing the heading, and on the **begin** and **end** associated with the procedure or function body. Using this field you can easily find the procedure or function body for its corresponding heading when there are nested procedures declared between the heading and its body.

Note that if the source being shown in the listing is being skipped due to a **\$IFC** Compiler command, the lexical information (fields 4 and 5) is *not* shown. You can then tell from the listing what is being skipped.

2. A *minimum listing* containing all the basic listing information plus the LisaBug procedure-relative addresses corresponding to the statements. Generally, the addresses reflect the start of the associated statements. This is the form of listing produced by the Code Generator when **\$ASM-** is in effect (either by option or Compiler commands).
3. A *full listing* containing the basic listing plus the generated assembly code interleaved with the Pascal source. In general, the code generated for a statement follows that statement, but there are some conditions which cause the code to precede its associated statement. The full listing is produced when **\$ASM+** is in effect (either by option or Compiler commands).
4. A *full listing by procedure* containing the basic listing plus the generated assembly code on a procedure basis, that is, all the source for a procedure is shown before its generated code. This listing is produced when **\$ASM+** is in effect and you specify the **\$ASM PROC** option.
5. An *Assembler input source* containing the original Pascal source as comments interleaved with the corresponding assembly code. This listing is produced when **\$ASM+** is in effect and you specify the **\$ASM ONLY** option. There is no guarantee that the source produced is completely valid Assembler input (although what is generated will be syntactically correct). The Code Generator generates appropriate **.DEF** and **.REF** statements and labels for branches and data. Procedure references whose names conflict with Assembler opcodes and directives are renamed by padding the original name with percent characters (e.g., "MOVE" would become "MOVE%%"). A conflicting name is defined as one that occurs in the Assembler's opcode file **N68K.OPCODES**. (This file is now also used by the Code Generator when the **\$ASM ONLY** option is used.)

6. An *Assembler input source by procedure* containing the original Pascal source for an entire procedure as comments followed by the corresponding assembly code. This listing is produced when **\$ASM+** is in effect and you specify both the Code Generator options **\$ASM ONLY** and **\$ASM PROC**.

Note that the only way to see the generated code is to use **\$ASM+**, either as an option to the Compiler or Code Generator or as Compiler directives. **\$ASM PROC** causes the display of the code on a procedure basis, and **\$ASM ONLY** causes the listing to be produced in Assembler input format.

## LISTING FORMAT #1 - Basic listing format as produced by the Compiler

Lisa Pascal Compiler V3.22 (14-Jun-84)

13:31:43 15-Jun-84

```

1      1 -- PROGRAM Example;
2      2 --
3      3 --     VAR
4      4 --         Argument: LongInt;
5      5 --
6      6 --     ($I Factorial)
7  1   1 -- A   FUNCTION Factorial(Arg: LongInt): LongInt;
8  1   2 --
9  1   3 0- A   BEGIN (Factorial)
10 1   4 --     IF Arg<=1 THEN
11 1   5 --         Factorial := 1
12 1   6 --     ELSE
13 1   7 --         Factorial := Arg*Factorial(Arg-1);
14 1   8 -0 A   END; (Factorial)
15      7 --
16     8 0-   BEGIN (Example)
17     9 1-   REPEAT
18     10 --       WriteLn;
19     11 --       Write('Enter argument: ');
20     12 --       Read(Argument);
21     13 --       IF (IOResult<=0) AND (Argument>=0) THEN
22     14 --           WriteLn('Factorial(', Argument: 1, ') = ',
23     15 --               Factorial(Argument): 1);
24     16 -1   UNTIL Argument<0;
25     17 -0   END. (Example)

```

Elapsed time: 1.483 seconds.

Compilation complete - no errors found. 25 lines.

## LISTING FORMAT #2 - Minimum listing format showing LisaBug addresses

Lisa Pascal Compiler V3.22 (14-Jun-84) 13:31:43 15-Jun-84  
 Lisa Pascal MC68000 Code Generator V3.14 (14-Jun-84) 13:36:41 15-Jun-84

```

1      1 --          PROGRAM Example;
2      2 --
3      3 --          VAR
4      4 --          Argument: LongInt;
5      5 --
6      6 --          {$I Factorial}
7 1    1 -- A      FUNCTION Factorial(Arg: LongInt): LongInt;
8 1    2 --
9 1    3 0- A      BEGIN (Factorial)
10 1   4 -- 000008   IF Arg<=1 THEN
11 1   5 -- 000012   Factorial := 1
12 1   6 -- 00001A   ELSE
13 1   7 -- 00001A   Factorial := Arg*Factorial(Arg-1);
14 1   8 -0 A      END; (Factorial)
15    7 --
16    8 0-      BEGIN (Example)
17    9 1-      REPEAT
18   10 -- 000016   WriteLn;
19   11 -- 00001E   Write('Enter argument: ');
20   12 -- 00002C   Read(Argument);
21   13 -- 000038   IF (IOResult<=0) AND (Argument>=0) THEN
22   14 -- 00004A   WriteLn('Factorial(', Argument: 1, ') =',
23   15 -- 00004A   Factorial(Argument): 1);
24   16 -1 00009C   UNTIL Argument<0;
25   17 -0      END. (Example)

```

Elapsed compilation time: 1.483 seconds.

Compilation complete - no errors found. 25 lines.

Elapsed code generator time: 1.228 seconds.

Total code size = 284

**LISTING FORMAT #3 - Full listing format with generated code interleaved**

Lisa Pascal Compiler V3.22 (14-Jun-84)

13:31:43 15-Jun-84

Lisa Pascal MC68000 Code Generator V3.14 (14-Jun-84)

13:37:09 15-Jun-84

```

1      1 --          PROGRAM Example;
2      2 --
3      3 --          VAR
4      4 --          Argument: LongInt;
5      5 --
6      6 --          ($I Factorial)
7  1   1 -- A      FUNCTION Factorial(Arg: LongInt): LongInt;
8  1   2 --
9  1   3 0- A      BEGIN (Factorial)
                000000 4A6F F000      FACTORIA TST.W  $F000(A7)
                000004 4E56 0000      LINK     A6,$F000
10  1   4 --          IF Arg<=1 THEN
                000008 0CAE 0000 0001      CNPI.L  $$00000001,$0008(A6)
                00000E 0008
                000010 6E08      BGT.S   L0001      ; 0000001A
11  1   5 --          Factorial := 1
                000012 7001      MOVEQ   $$01,DO
                000014 2D40 000C      MOVE.L  DO,$000C(A6)
                000018 601A      BRA.S   L0002      ; 00000034
12  1   6 --          ELSE
13  1   7 --          Factorial := Arg*Factorial(Arg-1);
                00001A 42A7      CLR.L   -(A7)
                00001C 202E 0008      MOVE.L  $0008(A6),DO
                000020 5380      SUBQ.L  $$1,DO
                000022 2F00      MOVE.L  DO,-(A7)
                000024 4EBA 0000      JSR    FACTORIA
                000028 2F2E 0008      MOVE.L  $0008(A6),-(A7)
                00002C 4EBA 0000      JSR    %I_MUL4
                000030 2D5F 000C      MOVE.L  (A7)+,$000C(A6)
                000034 4E5E      UNLK   A6
                000036 2E9F      MOVE.L  (A7)+,(A7)
                000038 4E75      RTS
                00003A C641 4354 4F52      .WORD  $C641,$4354,$4F52 ; ".ACTOR"
                000040 4941      .WORD  $4941      ; "IA"
                000042 0000      CstSize .WORD  Last-CstSize-2
                000044      Last
14  1   8 -0 A      END; (Factorial)
15  1   7 --
16  1   8 0-      BEGIN (Example)
17  1   9 1-      REPEAT
                000000 4EBA 0000      EXAMPLE JSR    %_BEGIN
                000004 4E56 0000      LINK     A6,$F0000
                000008 2C5F      MOVE.L  (A7)+,A6
                00000A 4E55 FFFC      LINK     A5,$FFFC
                00000E 9FED 0010      SUBA.L  $0010(A5),A7
                000012 4EBA 0000      JSR    %_INIT
18  1  10 --          WriteLn;
                000016 2F2D 000C      MOVE.L  $000C(A5),-(A7)
                00001A 4EBA 0000      JSR    %%_LN
19  1  11 --          Write('Enter argument: ');
                00001E 2F2D 000C      MOVE.L  $000C(A5),-(A7)
                000022 487A 00A2      PEA    Cst0003      ; 0000000C
                000026 4267      CLR.W  -(A7)
                000028 4EBA 0000      JSR    %%_STR
20  1  12 --          Read(Argument);

```

```

00002C 2F2D 0008          MOVE.L $0008(A5),-(A7)
000030 4EBA 0000          JSR    %R_I
000034 2B5F FFFC          MOVE.L (A7)+,$FFFC(A5)
21      13 --          IF (IOResult=<=0) AND (Argument)=0) THEN
000038 4EBA 0000          JSR    %IORES
00003C 4A5F                TST.W  (A7)+
00003E 5FC0                SLE    DO
000040 4AAD FFFC          TST.L  $FFFC(A5)
000044 50C1                SSE    D1
000046 C001                AND.B  D1,DO
000048 674A                BEQ.S  L0001
22      14 --          WriteLn('Factorial(', Argument: 1, ') =',
23      15 --          Factorial(Argument): 1);
00004A 2F2D 000C          MOVE.L $000C(A5),-(A7)
00004E 487A 006A          PEA    Cst0002
000052 4267                CLR.W  -(A7)
000054 4EBA 0000          JSR    %M_STR
000058 2F2D 000C          MOVE.L $000C(A5),-(A7)
00005C 2F2D FFFC          MOVE.L $FFFC(A5),-(A7)
000060 3F3C 0001          MOVE.W #$0001,-(A7)
000064 4EBA 0000          JSR    %M_I
000068 2F2D 000C          MOVE.L $000C(A5),-(A7)
00006C 487A 0048          PEA    Cst0001
000070 4267                CLR.W  -(A7)
000072 4EBA 0000          JSR    %M_STR
000076 2F2D 000C          MOVE.L $000C(A5),-(A7)
00007A 42A7                CLR.L  -(A7)
00007C 2F2D FFFC          MOVE.L $FFFC(A5),-(A7)
000080 4EBA 0000          JSR    FACTORiA
000084 3F3C 0001          MOVE.W #$0001,-(A7)
000088 4EBA 0000          JSR    %M_I
00008C 2F2D 000C          MOVE.L $000C(A5),-(A7)
000090 4EBA 0000          JSR    %M_LN
000094 4AAD FFFC          L0001  TST.L  $FFFC(A5)
000098 6C00 FF7C          BGE    L0002
24      16 -1          UNTIL Argument<0;
00009C 4EBA 0000          JSR    %_TERM
0000A0 4E5D                UNLK   A5
0000A2 4EBA 0000          JSR    %_END
0000A6 4E75                RTS
0000A8 4E5E                UNLK   A6
0000AA 4E75                RTS
0000AC C558 4140 504C      .WORD  $C558,$4140,$504C ; ".XAMPL"
0000B2 4520                .WORD  $4520 ; "E "
0000B4 0022                CstSize .WORD  Last-CstSize-2
0000B6                Cst0001
0000B8 03                .BYTE  3
0000BA 2920 3D                .ASCII  ')' = '
0000BB                Cst0002
0000BC 0A                .BYTE  10
0000BE 4661 6374 6F72      .ASCII  'Factor'
0000C1 6961 6C28          .ASCII  'ial('
0000C5 00                .BYTE  $00
0000C6                Cst0003
0000C8 10                .BYTE  16
0000CA 456E 7465 7220      .ASCII  'Enter '
0000CC 6172 6775 6D65      .ASCII  'argume'
0000D3 6E74 3A20          .ASCII  'nt: '
0000D7 00                .BYTE  $00
0000E8                Last

```



```
25      17 -0          END. (Example)
```

Elapsed compilation time: 1.483 seconds.

Compilation complete - no errors found. 25 lines.

Elapsed code generator time: 3.106 seconds.

Total code size = 284

## LISTING FORMAT #4 - Full listing format with the \$ASM PROC in effect

Lisa Pascal Compiler V3.22 (14-Jun-84)

13:31:43 15-Jun-84

Lisa Pascal MC68000 Code Generator V3.14 (14-Jun-84)

13:38:34 15-Jun-84

```

1      1 --      PROGRAM Example;
2      2 --
3      3 --      VAR
4      4 --      Argument: LongInt;
5      5 --
6      6 --      ($I Factorial)
7 1    1 -- A    FUNCTION Factorial(Arg: LongInt): LongInt;
8 1    2 --
9 1    3 0- A    BEGIN (Factorial)
10 1   4 --      IF Arg<=1 THEN
11 1   5 --      Factorial := 1
12 1   6 --      ELSE
13 1   7 --      Factorial := Arg*Factorial(Arg-1);
14 1   8 -0 A    END; (Factorial)
          000000 4A6F F000      FACTORIA TST.W  $F000(A7)
          000004 4E56 0000      LINK   A6,$F000
          000008 0CAE 0000 0001  CMPI.L  #$00000001,$0008(A6)
          00000E 0008
          000010 6E08              BGT.S  L0001          ; 0000001A
          000012 7001              MOVEQ  #301,DO
          000014 2D40 000C      MOVE.L DO,$000C(A6)
          000018 601A              BRA.S  L0002          ; 00000034
          00001A 42A7      L0001  CLR.L  -(A7)
          00001C 202E 0008      MOVE.L $0008(A6),DO
          000020 5380              SUBQ.L #31,DO
          000022 2F00              MOVE.L DO,-(A7)
          000024 4EBA 0000      JSR   FACTORIA
          000028 2F2E 0008      MOVE.L $0008(A6),-(A7)
          00002C 4EBA 0000      JSR   %I MUL4
          000030 2D5F 000C      MOVE.L (A7)+,$000C(A6)
          000034 4E5E      L0002  UNLK  A6
          000036 2E9F      MOVE.L (A7)+,(A7)
          000038 4E75              RTS
          00003A C641 4354 4F52      .WORD  $C641,$4354,$4F52 ; ".ACTOR"
          000040 4941              .WORD  $4941          ; "IA"
          000042 0000      CstSize .WORD  Last-CstSize-2
          000044      Last
15     7 --
16     8 0-      BEGIN (Example)
17     9 1-      REPEAT
18     10 --      WriteLn;
19     11 --      Write('Enter argument: ');
20     12 --      Read(Argument);
21     13 --      IF (IOResult<=0) AND (Argument>=0) THEN
22     14 --      WriteLn('Factorial(', Argument: 1, ') = ',
23     15 --      Factorial(Argument): 1);
24     16 -1     UNTIL Argument<0;
25     17 -0     END; (Example)
          000000 4EBA 0000      EXAMPLE JSR   % BEGIN
          000004 4E56 0000      LINK   A6,$F000
          000008 2C5F      MOVE.L (A7)+,A6
          00000A 4E55 FFFC      LINK   A5,$FFFC
          00000E 9FED 0010      SUBA.L $0010(A5),A7
          000012 4EBA 0000      JSR   % INIT
          000016 2F2D 000C      L0002  MOVE.L $000C(A5),-(A7)

```

00001A	4EBA	0000		JSR	W_LN	
00001E	2F2D	000C		MOVE.L	\$000C(A5),-(A7)	
000022	487A	00A2		PEA	Cst0003	; 000000C6
000026	4267			CLR.W	-(A7)	
000028	4EBA	0000		JSR	W_STR	
00002C	2F2D	0008		MOVE.L	\$0008(A5),-(A7)	
000030	4EBA	0000		JSR	W_I	
000034	2B5F	FFFC		MOVE.L	(A7)+,\$FFFC(A5)	
000038	4EBA	0000		JSR	%_IORES	
00003C	4A5F			TST.W	(A7)+	
00003E	5FC0			SLE	D0	
000040	4AAD	FFFC		TST.L	\$FFFC(A5)	
000044	5CC1			SGE	D1	
000046	0001			AND.B	D1,D0	
000048	674A			BEQ.S	L0001	; 00000094
00004A	2F2D	000C		MOVE.L	\$000C(A5),-(A7)	
00004E	487A	006A		PEA	Cst0002	; 000000BA
000052	4267			CLR.W	-(A7)	
000054	4EBA	0000		JSR	W_STR	
000058	2F2D	000C		MOVE.L	\$000C(A5),-(A7)	
00005C	2F2D	FFFC		MOVE.L	\$FFFC(A5),-(A7)	
000060	3F3C	0001		MOVE.W	#\$0001,-(A7)	
000064	4EBA	0000		JSR	W_I	
000068	2F2D	000C		MOVE.L	\$000C(A5),-(A7)	
00006C	487A	00A8		PEA	Cst0001	; 000000B6
000070	4267			CLR.W	-(A7)	
000072	4EBA	0000		JSR	W_STR	
000076	2F2D	000C		MOVE.L	\$000C(A5),-(A7)	
00007A	42A7			CLR.L	-(A7)	
00007C	2F2D	FFFC		MOVE.L	\$FFFC(A5),-(A7)	
000080	4EBA	0000		JSR	FACTORIA	
000084	3F3C	0001		MOVE.W	#\$0001,-(A7)	
000088	4EBA	0000		JSR	W_I	
00008C	2F2D	000C		MOVE.L	\$000C(A5),-(A7)	
000090	4EBA	0000		JSR	W_LN	
000094	4AAD	FFFC	L0001	TST.L	\$FFFC(A5)	
000098	6C00	FF7C		BGE	L0002	; 00000016
00009C	4EBA	0000		JSR	%_TERM	
0000A0	4E5D			UNLK	A5	
0000A2	4EBA	0000		JSR	%_END	
0000A6	4E75			RTS		
0000A8	4E5E			UNLK	A6	
0000AA	4E75			RTS		
0000AC	C558	414D	504C	.WORD	\$C558,\$414D,\$504C	; ".XAMPL"
0000B2	4520			.WORD	\$4520	; "E "
0000B4	0022		CstSize	.WORD	Last-CstSize-2	
0000B6			Cst0001			
0000B6	03			.BYTE	3	
0000B7	2920	3D		.ASCII	' ) ='	
0000BA			Cst0002			
0000BA	0A			.BYTE	10	
0000BB	4661	6374	6F72	.ASCII	'Factor'	
0000C1	6961	6C28		.ASCII	'ial('	
0000C5	00			.BYTE	\$00	
0000C6			Cst0003			
0000C6	10			.BYTE	16	
0000C7	456E	7465	7220	.ASCII	'Enter '	
0000CD	6172	6775	6D65	.ASCII	'argume'	
0000D3	6E74	3A20		.ASCII	'nt: '	
0000D7	00			.BYTE	\$00	

000006                    Last

Elapsed compilation time: 1.483 seconds.

Compilation complete - no errors found. 25 lines.

Elapsed code generator time: 2.646 seconds.

Total code size = 284

## LISTING FORMAT #5 - Assembler input interleaved with Pascal source as comments

```

; PROGRAM Example;
;
;   VAR
;     Argument: LongInt;
;
;   ($I Factorial)
;   FUNCTION Factorial(Arg: LongInt): LongInt;
;
;     BEGIN (Factorial)
;
;       .FUNC  FACTORIA
;
;       .REF   %I_MULA
;       .REF   FACTORIA
;
;       TST.W  -4096(A7)
;       LINK  A6,#0
;
;       IF Arg<=1 THEN
;       CHPI.L #1,8(A6)
;       BGT.S  L0001
;
;       Factorial := 1
;       MOVEQ  #1,D0
;       MOVE.L D0,12(A6)
;       BRA.S  L0002
;
;       ELSE
;       Factorial := Arg*Factorial(Arg-1);
L0001  CLR.L  -(A7)
;       MOVE.L 8(A6),D0
;       SUBQ.L #1,D0
;       MOVE.L D0,-(A7)
;       JSR   FACTORIA
;       MOVE.L 8(A6),-(A7)
;       JSR   %I_MULA
L0002  MOVE.L (A7)+,12(A6)
;       UNLK  A6
;       MOVE.L (A7)+,(A7)
;       RTS
;
;       .WORD  $C641,$4354,$4F52,$4941
;
; CstSize .WORD  Last-CstSize-2
Last
;     END; (Factorial)
;
;   BEGIN (Example)
;   REPEAT
;
;     .MAIN  EXAMPLE
;
;     .REF  %_END
;     .REF  %_TERM
;     .REF  %I_1
;     .REF  %_IORES
;     .REF  %R_1
;     .REF  %M_STR
;     .REF  %M_LN
;     .REF  FACTORIA
;     .REF  %_INIT
;     .REF  %_BEGIN

```

```

;
;      JSR      % BEGIN
;      LINK    A6, #0
;      MOVE.L  (A7)+, A6
;      LINK    A5, #4
;      SUBA.L  16(A5), A7
;      JSR     % INIT
;      WriteLn;
L0002  MOVE.L  12(A5), -(A7)
;      JSR     %W_LN
;      Write('Enter argument: ');
;      MOVE.L  12(A5), -(A7)
;      PEA    Cst0003
;      CLR.W  -(A7)
;      JSR     %W_STR
;      Read(Argument);
;      MOVE.L  8(A5), -(A7)
;      JSR     %R_I
;      MOVE.L  (A7)+, -4(A5)
;      IF (IOResult<=0) AND (Argument)=0) THEN
;      JSR     % IORES
;      TST.W  (A7)+
;      SLE    D0
;      TST.L  -4(A5)
;      SGE    D1
;      AND.B  D1, D0
;      BEQ.S  L0001
;      WriteLn('Factorial(', Argument: 1, ') =',
;      Factorial(Argument): 1);
;      MOVE.L  12(A5), -(A7)
;      PEA    Cst0002
;      CLR.W  -(A7)
;      JSR     %W_STR
;      MOVE.L  12(A5), -(A7)
;      MOVE.L  -4(A5), -(A7)
;      MOVE.W  #1, -(A7)
;      JSR     %W_I
;      MOVE.L  12(A5), -(A7)
;      PEA    Cst0001
;      CLR.W  -(A7)
;      JSR     %W_STR
;      MOVE.L  12(A5), -(A7)
;      CLR.L  -(A7)
;      MOVE.L  -4(A5), -(A7)
;      JSR     FACTORIA
;      MOVE.W  #1, -(A7)
;      JSR     %W_I
;      MOVE.L  12(A5), -(A7)
;      JSR     %W_LN
L0001  TST.L  -4(A5)
;      BGE    L0002
;      UNTIL Argument<0;
;      JSR     % TERM
;      UNLK   A5
;      JSR     % END
;      RTS
;      UNLK   A6
;      RTS
;
;      .WORD  $C558, $414D, $504C, $4520
;
;      CstSize .WORD  Last-CstSize-2

```

```
Cst0001  .BYTE  3
         .ASCII  ')' =
Cst0002  .BYTE  10
         .ASCII  'Factorial('
         .BYTE  $00
Cst0003  .BYTE  16
         .ASCII  'Enter argument: '
         .BYTE  $00
Last
;      END. (Example)
;
         .END
```

## LISTING FORMAT #6 - Assembler input with the \$ASM PROC in effect

```

; PROGRAM Example;
;
;   VAR
;   Argument: LongInt;
;
;   ($I Factorial)
;   FUNCTION Factorial(Arg: LongInt): LongInt;
;
;   BEGIN (Factorial)
;     IF Arg<=1 THEN
;       Factorial := 1
;     ELSE
;       Factorial := Arg*Factorial(Arg-1);
;     END; (Factorial)
;
;   .FUNC   FACTORIA
;
;   .REF    %I MULA
;   .REF    FACTORIA
;
;   TST.W  -4096(A7)
;   LINK  A6,#0
;   CMPI.L #1,8(A6)
;   BGT.S  L0001
;   MOVEQ  #1,D0
;   MOVE.L D0,12(A6)
;   BRA.S  L0002
; L0001   CLR.L  -(A7)
;   MOVE.L 8(A6),D0
;   SUBQ.L #1,D0
;   MOVE.L D0,-(A7)
;   JSR    FACTORIA
;   MOVE.L 8(A6),-(A7)
;   JSR    %I MULA
;   MOVE.L (A7)+,12(A6)
; L0002   UNLK  A6
;   MOVE.L (A7)+,(A7)
;   RTS
;
;   .WORD  $0641,$4354,$4F52,$4941
;
; CstSize .WORD  Last-CstSize-2
; Lst
;
; BEGIN (Example)
; REPEAT
;   WriteLn;
;   Write('Enter argument: ');
;   Read(Argument);
;   IF (IOResult<=0) AND (Argument>=0) THEN
;     WriteLn('Factorial(', Argument: 1, ') =',
;           Factorial(Argument): 1);
;   UNTIL Argument<0;
; END. (Example)
;
; .MAIN   EXAMPLE
;
; .REF    %END
; .REF    %TERM
; .REF    %M_I

```



```

        .REF    % IORES
        .REF    %R_I
        .REF    %W_STR
        .REF    %W_LN
        .REF    FACTORIA
        .REF    %_INIT
        .REF    %_BEGIN
:
        JSR    %_BEGIN
        LINK   A6,#0
        MOVE.L (A7)+,A6
        LINK   A5,#-4
        SUBA.L 16(A5),A7
L0002  JSR    %_INIT
        MOVE.L 12(A5),-(A7)
        JSR    %W_LN
        MOVE.L 12(A5),-(A7)
        PEA   C$10003
        CLR.W  -(A7)
        JSR    %W_STR
        MOVE.L 8(A5),-(A7)
        JSR    %R_I
        MOVE.L (A7)+,-4(A5)
        JSR    % IORES
        TST.W  (A7)+
        SLE    D0
        TST.L  -4(A5)
        SGE    D1
        AND.B  D1,D0
        BEQ.S  L0001
        MOVE.L 12(A5),-(A7)
        PEA   C$10002
        CLR.W  -(A7)
        JSR    %W_STR
        MOVE.L 12(A5),-(A7)
        MOVE.L -4(A5),-(A7)
        MOVE.W #1,-(A7)
        JSR    %R_I
        MOVE.L 12(A5),-(A7)
        PEA   C$10001
        CLR.W  -(A7)
        JSR    %W_STR
        MOVE.L 12(A5),-(A7)
        CLR.L  -(A7)
        MOVE.L -4(A5),-(A7)
        JSR    FACTORIA
        MOVE.W #1,-(A7)
        JSR    %R_I
        MOVE.L 12(A5),-(A7)
        JSR    %W_LN
L0001  TST.L  -4(A5)
        BGE   L0002
        JSR    %_TERM
        UNLK  A5
        JSR    %_END
        RTS
        UNLK  A6
        RTS
:
        .WORD  $C558,$4140,$504C,$4520
:
CstSize .WORD  Last-CstSize-2

```

```
Cst0001  .BYTE  3  
        .ASCII  ')' ='  
Cst0002  .BYTE  10  
        .ASCII  'Factorial(''  
        .BYTE  $00  
Cst0003  .BYTE  16  
        .ASCII  'Enter argument: '  
        .BYTE  $00  
Last  
:  
        .END
```



## Index

Please note that the topic references in this index are by *section number*.

### A

Abs Function 11.4.2  
 Abs2X D.4.3, D.4.12  
 Absolute value D.9.2  
 AbsX D.3.9.2, D.3.12  
 Accuracy in Real Arithmetic D  
 ACosX D.4.3, D.4.12  
 Actual-Parameter 5.2, 7.1, 7.3  
     syntax 5.2  
 Actual-Parameter-List 5.2  
     syntax 5.2  
 Actual-Parameters in Procedure Call 6.1.2  
 Add, D.3.3.1  
 AddPtd Procedure E.9.17  
 AddC, D.3.3.1, D.3.12  
 AddD D.3.3.1, D.3.12  
 AddS D.3.3.1, D.3.12  
 AddX D.3.3.1, D.3.12  
 Anomalies in Lisa Pascal B  
 Annuity D.3.10.3, D.3.12  
 Apple II Pascal A  
 Apple III Pascal A  
 Apple II and Apple III Pascal: Other Differences  
     A.3  
 Apple Numerics Manual D.1  
 Applestuff Unit A  
 Arc, Graphic Operations E.9.10  
 Arctan Function 11.4.9  
 Arctangent D.3.10.4  
 Arithmetic Functions 11.4  
 Arithmetic Operations D.3.3  
 Arithmetic Operators 5.1.2, D  
 Array 3.2.1, 4.3.1  
     component 3.2.1, 4.3.1  
     reference 4.3.1  
 Arrays and Matrices D.4.10.3  
 Array-type 3.2.1  
     syntax 3.2.1  
 Ascent Line E.5.2  
 ASCII 3.1.1.5  
 ASinX D.4.3, D.4.3, D.4.12

- Assembler Input Source J-2
- Assembler Input by Source J-3
- Assembly Language D. 5. 1
- Assembly Language, Quickdraw E. 11
- 6502 Assembly-Language SANE Engine D. 1
- 68000 Assembly-Language SANE Engine D. 1
- Assignment-Compatibility 3. 4. 3
- Assignment-Statement 6. 1. 1
  - syntax 6. 1. 1
- ATanX D. 3. 10. 4, D. 3. 12
- ATan2X D. 4. 3, D. 4. 12
- Auxiliary Procedures D. 3. 9

**B**

- BackColor Procedure E. 9. 5
- BackPat Procedure E. 9. 1
- Base-2 logarithm D. 3. 10. 1
- Base Line E. 5. 2
- Base-Type 3. 2. 3, 3. 3, 5. 3
  - of pointer-type 3. 3
  - syntax 3. 3
  - scope anomaly B
  - of set-type 3. 2. 3, 5. 3
- Basic Listing Formats J-1
- Beep Procedure F. 4
- Binary Log D. 3. 9. 4
- Binary Scale D. 3. 9. 4
- Bit Image E. 4. 1
- Bit Transfer Operations E. 9. 13
- BitMap Data Type E. 4. 2
- Bitmaps E. 4. 2
- Bitwise Boolean Operations A
- Blank Character 1. 1
- Blank Segment 8. 3, 9. 1
- Block 2
  - syntax 2. 1
- Block-Structured I/O 3. 2. 4,
  - 10. 1. 1-2, 10. 4
- Blockread Function 3. 2. 4, 10. 4. 1
- Blockwrite function 3. 2. 4, 10. 4. 2
- Boolean 3. 1. 1. 4, 5. 1. 3, 5. 1. 5. 2,
  - 10. 3. 3. 7, 12. 3-12. 4
  - comparisons 5. 1. 5. 2
  - constants as control values 12. 3. -4

- operands, evaluation of 5.1.3
  - operators 5.1.3
  - data type 3.1.1.4
  - values in text-oriented output
    - 10.3.3.7
- Boundary Rectangle E.4.2
- Boxes Program E.14.2
- Buffer Variable 10.1.3, 10.1.7
- Built-In Procedures and Functions 10, 11
- Busy Cursor F.2.2
- BusyDelay Procedures F.2.2
- BusyImage Procedures F.2.2
- Byte Array 11.7
- Byte-Oriented Procedures and Functions 11.7
- Byte-Size Files 3.2.4
- Bytestream Type A

*C*

- C2Dec D.3.4.2, D.3.12
- C2Str D.3.4.2, D.3.12
- C2X D.3.4.1, D.3.12
- Camera Eye E.12
- Case 6.2.2.2
  - syntax 6.2.2.2
- Case-Constant in Case Statement 6.2.2.2
- Case-Sensitivity 1.1, 1.2, 1.4
- Case-Statement 6.2.2.2, Notes 6-1
  - efficiency 12.5
  - syntax 6.2.2.2
- Char 1.6.1, 3.1.1.5, 10.3.1.1, 10.3.3.2, 11.5
  - constant 1.6.1
  - type 3.1.15
  - values in text-oriented I/O
    - 10.3.1.1, 10.3.3.2
- Character 1.1, 3.2.4, 4.3.1
  - device 3.2.4, 10.1.1-2
  - files 3.2.4
  - font E.5.2
  - in string 4.3.1

- set 1.1
- Character Style E. 5.2
- CharWidth Function E. 9.4
- Chr Function 11.5.2
- Class Functions D. 3.7.1
- ClassC D. 3.7.1, D. 3.12
- ClassD D. 3.7.1, D. 3.12
- ClassS D. 3.7.1, D. 3.12
- ClassX D. 3.7.1, D. 3.12
- ClearHits D. 4.2, D. 4.12
- ClearXcps D. 4.2, D. 4.12
- Clip30 Function E. 12.4
- ClipRect Procedure E. 9.1
- ClipRgn E. 5
- Clock/Calendar F. 8, F. 9
- Close Procedure 10.1.5
- ClosePicture Procedure E. 9.14
- ClosePoly Procedure E. 9.15
- ClosePort Procedure E. 9.1
- CloseRgn Procedure E. 9.11
- Closing a File 10.1.5
- CmpX D. 3.6, D. 3.12
- Code Generation 12.1
- Code Generator Invocation Options Notes 12-4
- Code Generator Invocation Options (Table)  
Notes 12-7
- Color Drawing E. 7.2
  - routines E. 9.5
- ColorBit Procedure E. 9.5
- Column Pivoting D. 4.10.9
- Comment 1.8
- Comp D. 3.2, D. 3.12
- Comparison to Apple II and Apple III Pascal
- Comparison Functions D. 3.6
- Comparisons 5.1.5
- Comparisons Involving NaNs D. 2.4
- Compatibility of Parameter Lists
  - 7.3.5
- Compatible Types 3.4
- Compile-Time Expressions and Variables
  - 12.2.1-3
- Compiler 1.8, 12, A
  - commands 1.8, 12.1-2, A, Notes 12-1
- Compiler Commands (Table) Notes 12-7
- Compiler Invocation Options Notes 12-2

- Compiler Invocation Options (Table) Notes 12-7
- Component of Array 3.2.1, 4.3.1
- Component of File 3.2.4, 4.3.3
- Component-Type of Array 3.2.1
- Component-Type of File 3.2.4
- Composing Transformations D.4.10.3
- Compound D.3.10.3, D.3.12
- Compound Interest D.3.10.3
- Compound-Statement 6.2.1
  - syntax 6.2.1
- Concat Function 11.6.3
- COND D.4.10.4
- Conditional Compilation 12.2
- Conditional-Statement 6.2.2
  - syntax 6.2.2
- Conditioned Problems D.4.10.4
- Condition number D.4.10.4, D.4.10.10
- Constant 1.4-7
  - syntax 1.7
- Constant-Declaration 1.7, 2.1, B
  - scope anomaly B
  - syntax 1.7
- Constant-Declaration-Part 2.1
  - syntax 2.1
- Constant Expressions Notes 1-1
- Constants, Assembly Language E.11.1
- Contrast Control F.3.1
- Contrast Function F.3.1
- Control-Variable 6.2.3.3
  - syntax 6.2.3.3
- Conversion, Type Notes 3-1
- Conversions D.3.4
- Conversions To and From Extended D.3.4.1
- Conversions Between Binary and Decimal D.3.4.2
- Converting Decimal Strings into SANE Types
  - D.3.4.2
- Converting SANE Types into Decimal Strings
  - D.3.4.2
- Coordinate Conversion D.4.3
- Coordinate Plane E.3.1
- Coordinates, GrafPort E.3.1, E.6
- Copy Function 11.6.4
- CopyBits Procedure E.9.13
- CopyRgn Procedure E.9.11
- Correctly Rounded Conversion D.4.7



- Correlation Matrix D. 4. 10. 7
- Cos Function 11. 4. 5
- CoshX D. 4. 3, D. 4. 3, D. 4. 12
- CosX D. 3. 10. 4, D. 3. 12
- Cosine D. 3. 10. 4
- CpySgnX D. 3. 9. 2, D. 3. 12
- CR Character 1. 1, 1. 6, 10. 3
  - in text-oriented I/O 10. 3
- Crunch 10. 1. 5
- Current Block Number 10. 4
- Current File Position 4. 3. 3
- Cursor Control 10. 3. 7, F. 2
- Cursor Data Type E. 4. 4
- Cursor-Handling Routines E. 9. 2
- CursorHeight Data Type F. 10
- CursorImage Procedure F. 2
- CursorLocation Procedure F. 2. 1
- CursorPtr Data Type F. 10
- Cursor, QuickDraw E. 4. 4
- CursorTracking Procedure F. 2. 1
- Customizing QuickDraw Operations
  - E. 10

**D**

- D2Dec D. 3. 4. 2, D. 3. 12
- D2Str D. 3. 4. 2, D. 3. 12
- D2X D. 3. 4. 1, D. 3. 12
- Data Bitmap F. 2
- Data Types D. 3. 2
- Data Types 3
  - assembly language E. 11. 2
  - Graf30 E. 12. 3, E. 13. 5
  - QuickDraw E. 2. 2, E. 13. 2
- DataFile 10. 1. 2
- Date F. 8, F. 9
- DateArray Data Type F. 10
- DateTime Procedure F. 8
- DateToTime Procedure F. 8
- DblPrecision D. 4. 12
- Dead Key Diacriticals F. 5. 4
- Debugging 12. 1
- Dec2C D. 3. 4. 2, D. 3. 12
- Dec2D D. 3. 4. 2, D. 3. 12
- Dec2S D. 3. 4. 2, D. 3. 12

- Dec2X D. 3. 4. 2, D. 3. 12
- DecForm D. 3. 4. 2, D. 3. 12
- Decimal D. 3. 4. 2, D. 3. 12
- Decimal Record Conversions D. 3. 4. 2
- Decimal Record Type D. 3. 4. 2
- DecStr D. 3. 4. 2, D. 3. 12
- DECSTRLEN D. 3. 12
- Defining Declaration 7. 1
- Delete Procedure 11. 6. 5
- Deletions A. 2
- DENORMAL D. 3. 7. 1, D. 3. 12
- Denormalized number D. 3. 7. 1
- Denormalized Numbers D. 3. 7
- Descent Line E. 5. 2
- Determinant D. 4. 10. 10
- Determinants D. 4. 10. 5
- Device 10. 1. 1-2
  - character 10. 1. 1, 10. 1. 2
  - file-structured 101. 1, 10. 1. 2
  - types 10. 1. 1, 10. 1. 2
- Diacritical Marks F. 5. 4
- DiffRgn Procedure E. 9. 11
- Digit 1. 1
- Digits D. 3. 4. 2, D. 3. 12
- Digit-Sequence 1. 4
  - syntax 1. 4
- DimContrast Function F. 3. 2
- Dimensions of Lisa Screen E. 4. 1
- Directive 1. 3
- Diskette Insertion Switches F. 5
- Display Screen F. 3
- DisposeRgn Procedure E. 9. 11
- DIVBYZERO D. 3. 8. 2, D. 3. 12
- Div Operator A
- DivC D. 3. 3. 1, D. 3. 12
- DivD D. 3. 3. 1, D. 3. 12
- DivS D. 3. 3. 1, D. 3. 12
- DivX D. 3. 3. 1, D. 3. 12
- Divide D. 3. 3. 1
- Division by Zero (Real Arithmetic)
  - 3. 1. 1. 3, D
- DLE Character 10. 3
- Double D. 3. 2, D. 3. 12
- DblPrecision D. 4. 2
- DOWNWARD D. 3. 8. 1, D. 3. 12

- DrawChar Procedure E. 9. 4
- Drawing E. 7
  - color E. 7. 2
- DrawPicture Procedure E. 9. 14
- DrawString Procedure E. 9. 4
- DrawText Procedure E. 9. 4
- Dynamic Allocation Procedures 11. 2
- Dynamic storage D. 4. 4

**E**

- Efficiency, Case-Statements 12. 5
- E format D. 4. 6
- ELEMS D. 3. 12
- Elementary Functions D. 3. 10, D. 4. 3
- Empty Set 5. 3
- EmptyRect Function E. 9. 6
- EmptyRgn Function E. 9. 11
- Enumerated-Type 3. 1. 2
  - syntax 3. 1. 2
- Environ D. 3. 8. 2, D. 3. 12
- Environmental Control D. 3. 8
- Eof Function 10. 1. 7
  - and various procedures 10. 1. 3-4,  
10. 1. 7, 10. 2. 1-2, 10. 2. 4,  
10. 3. 1-2, 10. 4. 1
- Eoln Function 10. 3. 5
  - and read and readln procedures  
10. 3. 1, 10. 3. 2
- EQ D. 3. 6, D. 3. 12
- Equal D. 3. 6
- EqualPt Function E. 9. 17
- EqualRect Function E. 9. 6
- EqualRgn Function E. 9. 11
- EraseArc Procedure E. 9. 10
- EraseOval Procedure E. 9. 8
- ErasePoly Procedure E. 9. 16
- EraseRect Procedure E. 9. 17
- EraseRgn Procedure E. 9. 12
- EraseRoundRect Procedure E. 9. 9
- Error Messages H
- Error Reporting H. 1
- ETX Character A
- Euclidean Length D. 4. 10. 3
- $E^x - 1$  D. 3. 10. 2

- Exception D. 3. 8. 2, D. 3. 12
- Exception Flags D. 3. 8. 2
- Existence D. 4. 10. 3
- Exit Procedure 11. 1. 1, A
- Exp D. 3. 4. 2, D. 3. 12, D. 4. 7, D. 4. 12
- Exp Function 11. 4. 6
- Exponential format D. 4. 6
- Exponentials D. 3. 10. 2
- Exp1X D. 3. 10. 2, D. 3. 12
- Exp2X D. 3. 10. 2, D. 3. 12
- ExpX D. 3. 10. 2, D. 3. 12
- Expression Evaluation D. 3. 5
- Expressions 5
  - syntax 5
- Extended D. 3. 2, D. 3. 12
- Extended Comparisons A
- Extended Temporaries D. 3. 5
- Extended-Based Expression Evaluation D. 3. 5
- Extensions A. 1
- External File 10. 1
- External Function 7. 2
- External Procedure 7. 1-2
- External Rate of Return D. 4. 9
- ExtPrecision D. 4. 12

*F*

- Factor 5
  - syntax 5
- FadeDelay Function F. 3. 2
- F format D. 4. 6
- Field of Record 3. 2. 2, 4. 3. 2, 6. 2. 4
- Field-Declaration 3. 2. 2
  - syntax 3. 2. 2
- Field-Designator 4. 3. 2
  - syntax 4. 3. 2
- Field-List 3. 2. 2
  - syntax 3. 2. 2
- File 3. 2. 4, 4. 3. 3, 10
  - buffer 4. 3. 3
- Buffer and Eof Function 10. 1. 7
- Buffer and Reset Procedure 10. 1. 3
- Component 3. 2. 4, 4. 3. 3
- Identifier As Parameter Type 7. 3
- Of Char 3. 2. 4
- Position and Reset Procedure

- 10.1.3
- Record 10.2
- Reference 4.3.3
- Species 10.1.2
- Standard File-Type Identifier
  - 3.2.4, 10.1, 10.4
- Types and Reset Procedure 10.1.3
- Variable 3.2.4, 4.3.3, 10
- File-Buffer-Symbol 4.3.3
  - syntax 4.3.3
- File-Structured Device 3.2.4,
  - 10.1.1-2, 10.4
- File-Type 3.2.4
  - syntax 3.2.4
- FillArc Procedure E.9.10
- FillChar Procedure 11.8.3
- FillOval Procedure E.9.8
- FillPoly Procedure E.9.16
- FillRect Procedure E.9.7
- FillRgn Procedure E.9.12
- FillRoundRect Procedure E.9.9
- Final-Value 6.2.3.3
  - syntax 6.2.3.3
- Financial Analysis D.4.8
- Financial Functions D.3.10
- Finite Real Values 3.1.1.3
- Fin-Npv D.4.8, D.4.12
- Fin-Return D.4.8, D.4.12
- FIXEDDECIMAL D.3.4.2, D.3.12
- Fixed Decimal Point Format D.4.6
- Fixed-Part 3.2.2
  - syntax 3.2.2
- Fixed-Point Output of Real Value
  - 10.3.3.4
- FLOATDECIMAL D.3.4.2, D.3.12
- Floating-Point Arithmetic D
- Floating-Point Output of Real Value
  - 10.3.3.4, A
- Font Numbers E.15
- Fonts E.5.2
- For-Statement 6.2.3.3
  - syntax 6.2.3.3
- ForeColor Procedure E.9.5
- Foreign Characters F.5.4
- Formal-Parameter-List 7.3

- syntax 7.3
- Formal-Parameters and Procedure Call
  - 6.1.2
- Forward Declaration 7.1-2, Notes 7-1
- FP68K D.4.5
- FP-Free-ASCII D.4.6, D.4.12.
- FPLib D.1, D.3, D.3.12, D.5.3
- FP-New D.4.4, D.4.12
- FP-Size D.4.4, D.4.12
- FP-Type D.4.4 D.4.12
- FPUnit D.5.3
- FrameArc Procedure E.9.10
- FrameCounter Function F.3
- FrameOval Procedure E.9.8
- FramePoly Procedure E.9.16
- FrameRect Procedure E.9.7
- FrameRgn Procedure E.9.12
- FrameRoundRect Procedure E.9.9
- Frames Data Type F.10
- Free Fomat D.4.6, D.4.12
- Free Format Conversion D.4.6
- Full Listing J-2
- Full Listing By Procedure J-2
- Full Rank D.4.10.2
- Function 7.2-3
- Function-Body 7.2
  - syntax 7.2
- Function-Call 5, 5.2, 7.2, 7.3
  - syntax: 5.2
- Function-Declaration 7.2
  - syntax 7.2
- Function-Heading 7.2
  - syntax 7.2
- Functional Parameter 7.3.4
- Functions, Assembly Language E.11.4
- Future Value D.3.10.3

**G**

- GE D.3.6, D.3.12
- GEL D.3.6, D.3.12
- Get Procedure 10.2.1, 10.2.3
- GetClip Procedure E.9.1
- GetEnv D.3.8.2, D.3.12

GetFontInfo Procedure E. 9. 4  
 GetHltAddress D. 3. 11, D. 3. 12  
 GetPen Procedure E. 9. 3  
 GetPenState Procedure E. 9. 3  
 GetPixel Function E. 9. 18  
 GetPort Procedure E. 9. 1  
 GetPort30 Procedure E. 12. 4  
 GetPrecision D. 4. 2, D. 4. 12  
 GetRnd D. 3. 8. 1, D. 3. 12  
 GL D. 3. 6, D. 3. 12  
 Global Coordinated E. 6, E. 9. 17  
 Global Constants D. 3. 5. 1  
 Global Variables, Assembly Language  
     E. 11. 3  
 GlobalToLocal Procedure E. 9. 17  
 Goto-Statement 6. 2, A  
     syntax 6. 1. 3  
 Gotoxy Procedures 10. 3. 7. 2  
 Graf30 E. 12  
     data types E. 12. 3, E. 13. 5  
     sample program E. 14. 2  
 GrafDevice Procedure E. 9. 1  
 GrafPort Coordinates E. 3. 1, E. 6  
 GrafPort Data Type E. 5  
 GrafPort Routines E. 9. 1  
 GrafPorts E. 5  
 GrafPtr Data Type E. 5  
 GrafVerb Data Type E. 10  
 Graphic Pen E. 5. 1  
 Greater than D. 3. 6  
 Greater than or equal D. 3. 6  
 Greater than or less than D. 3. 6  
 Greater than, equal, or less than D. 3. 6  
 GT D. 3. 6, D. 3. 12

**H**

Halt Address D. 3. 11  
 Halt Procedure 11. 1. 2, A  
 Halts D. 3. 8. 2  
 Halt Vector D. 3. 8. 2  
 Handles E. 3. 4  
     picture E. 8. 1  
     polygon E. 8. 2  
     region E. 3. 4

- Hardware Interface F
- Hardware Interface, Linking To Notes F-1
- Heap 11.2, D.4.4
- Heapresult Function 11.2.2
- Hex-Digit 1.1
- Hex-Digit-Sequence 1.4
  - syntax 1.4
- Hexadecimal Constants 1.4
- HideCursor Procedure E.9.2
- HidePen Procedure E.9.3
- Horner's Method D.4.9
- Horner's Rule D.3.5
- Host Program or Unit 9
- Host-Type of Subrange 3.1.3
- Hotspot E.4.4, F.2
- Hourglass Cursor F.2.2
- Hyperbolic Cosine D.4.3
- Hyperbolic Sine D.4.3
- Hyperbolic Tangent D.4.3

*I*

- I2X D.3.4.1, D.3.12
- Identical Types 3.4
- Identifier 1.2
  - of program 8.1
  - syntax 1.2
- Identifier-List 3.1.2
  - syntax 3.1.2
- Identity Procedure E.12.4.2
- IEEE Arithmetic D.2.1
- IEEE Standard D.3.1
- IEEE Standard D.3.1
- If-Statement 6.2.2.1
  - optimization 12.3
  - syntax 6.2.2
- Implementation-Part 9.1.1
  - syntax 9.1.1
- In Operator 5.1.5.5
- Index 4.3.1
  - in variable-reference 4.3.1
  - syntax 4.3.1
- Index-Type 3.2.1
  - syntax 3.2.1
- INEXACT D.3.8.2, D.3.12



- INF D. 2. 1
- INFINITE D. 3. 7. 1, D. 3. 12
- Infinites 3. 1. 1. 3, D. 3. 7
- Infinites D. 3. 7
- Infinity D. 2. 1 D. 3. 7. 1
- InitCursor Procedure E. 9. 2
- InitFPLib D. 3. 11, D. 3. 12
- InitGraf Procedure E. 9. 1
- Initial-Value 6. 2. 3. 3
  - syntax 6. 2. 3. 3
- Initialization-Part A
- InitPort Procedure E. 9. 1
- Inline Declaration Notes 7-1
- Input (Standard File) 10. 1. 7, 10. 3
- Input File Control (In Compilation)
  - 12. 1
- Input Variables in Read Procedure
  - 10. 3. 1
- Input/Output 10, Notes 10-1
- Inquiries D. 3. 7. 1
- Insert Procedure 11. 6. 6
- InsetRect Procedure E. 9. 6
- InsetRgn Procedure E. 9. 11
- Int-EForm D. 4. 6, D. 4. 12
- Integer 1. 4, 3. 1. 1. 1-2, 10. 3. 1. 2,
  - 10. 3. 3. 3, 11. 3-5, D
  - arithmetic 3. 1. 1. 1, 3. 1. 1. 2
  - constant 1. 4
  - conversion overflow D
  - data type 3. 1. 1. 1, 3. 1. 1. 2
  - data type conversions 3. 1,
    - 3. 1. 1. 5, 3. 1. 2, 11. 5. 1
  - values in text-oriented I/O
    - 10. 3. 1. 2, 10. 3. 3. 3
- Interactive File-Type A
- Integral format D. 4. 6
- Interface D. 3. 12
- INTERFACE D. 4. 12
- Interface-Part 9. 1. 1
  - syntax 9. 1. 1
- IRR D. 4. 8
- Internal Rate of Return D. 4. 8
- Intrinsic Libraries Notes 9-3
- Intrinsic-Unit Syntax Notes 9-2
- INTRINSIC. LIB 9. 2, 12. 1

INVALID D. 3. 8. 2, D. 3. 12  
Invalid Operations in Real Arithmetic  
Inverse D. 4. 10. 1  
Inverse cosine D. 4. 3  
Inverses D. 4. 10. 3  
Inverse sine D. 4. 3  
InvertArc Procedure E. 9. 10  
InvertOval Procedure E. 9. 8  
InvertPoly Procedure E. 9. 16  
InvertRect Procedure E. 9. 7  
InvertRgn Procedure E. 9. 12  
InvertRoundRect Procedure E. 9. 9  
Iresult Function 10. 1. 2, 10. 1. 6  
IOSFPLib D. 1, D. 4  
IOSPasLib D. 1  
Iteritive Improvement D. 4. 10. 6

*K*

Key State F. 5. 3  
KeyboEvent Function F. 5. 3  
KeyboId Data Type F. 10  
KeyboPeek Function F. 5. 3  
KeyboQIndex Data Type F. 10  
Keyboard 3. 2. 4, 10. 1. 1, 10. 3,  
10. 3. 7. 1, F. 5  
    attributes F. 5. 1  
    echoing on input 10. 3  
    events F. 5, F. 5. 3  
    identification F. 5. 1  
    layouts F. 5. 1  
    legends F. 5. 1  
    physical 3. 2. 4, 10. 1. 1, 10. 3,  
    10. 3. 7. 1  
    queue F. 5. 3  
    repeats F. 5. 5  
    state F. 5. 1  
    testing 10. 3. 7. 1  
Keyboard Function F. 5. 1  
KeyCap Data Type F. 10  
KeyCapSet Data Type F. 10  
Keycodes F. 5  
KeyEvent Data Type F. 10  
KeyIsDown Function F. 5. 2  
KeyMap Procedure F. 5. 2

Keypress Function 10.3.7.1  
Keystate F.5.3  
KillPicture Procedure E.9.14  
KillPoly Procedure E.9.15

*L*

L2X D.3.4.1, D.3.12  
Label 1.5, 2.1, 6  
    on statement 6  
    syntax 2.1, 6  
Label-Declaration-Part 2.1  
    syntax 2.1  
LDec2X D.4.7, D.4.12  
LE D.3.6, D.3.12  
Legends Function F.5.1  
Length Attribute 3.1.1.6  
Length Function 11.6.1  
Less than D.3.6  
Less than or equal D.3.6  
Letter 1.1  
Libraries, Intrinsic Notes 9-3  
Linear Algebra D.4.10  
Linear Algebra Procedures D.4.10.8  
Linear Equations D.4.10.3  
Linear Least Squares D.4.10.3  
Lineat Least Squares Problems D.4.10.9  
Line-Drawing Routines E.9.3  
Line Procedure E.9.3  
Line2D Procedure E.12.4  
Line3D Procedure E.12.4  
LineTo Procedure E.9.3  
LineTo2D Procedure E.12.4  
LineTo3D Procedure E.12.4  
Linker 7.1  
Linking D.1  
Lisa Extended Character Set G  
Listing Control 12.1  
Listing Formats J  
Ln Function 11.4.7  
Local Coordinates E.6, E.9.17  
LocalToGlobal Procedure E.9.17  
Lock 10.1.5  
Logarithms D.3.10.1  
LogbX D.3.9.4, D.3.12  
Loge (1 + x) D.3.10.1

Log2X D. 3.10.1, D. 3.12  
LnX D. 3.10.1, D. 3.12  
Ln1X D. 3.10.1, D. 3.12  
LongDecimal D. 4.7, D. 4.12  
Long Integer Data type A  
Longint 1.4, 3.1.1.2, 10.3.1.2,  
10.3.3.3, 11.3-5, D  
arithmetic 3.1.1.2  
constant 1.4, 1.6, 1.7  
11.3.4  
data type 3.1.1.2  
data type conversions 11.3.3,  
values in text-oriented I/O  
10.3.3.3  
LongSigDig D. 4.7, D. 4.12  
LookAt Procedure E.12.4.1  
LSigDigLen D. 4,7, D. 4.12  
Lt D. 3.6, D. 3.12

*M*

Macintosh D.1  
Macintosh Code Generation Notes 12-6  
Macintosh Floating-Point Programming D. 4.5  
Macvkorks D.5  
Managing Environmental Settings D.3.8.3  
ManyPixels Data Type F.10  
MapPoly Procedures E.9.18  
MapPt Procedure E.9.18  
MapRect Procedure E.9.18  
MapRgn Procedure E.9.18  
Mark D.4.4  
Mark Procedure 11.2.3, A  
Mask Bitmap F.2  
MathLib D.1, D.4, D.4.12, D.5.3  
Math-Solve D.4.9, D.4.12  
Math Sort D.4.5  
Math-Sort D.4.5, D.4.12  
MathUnit D.5.3  
Mat-Mult D.4.10.8, D.4.12  
Matrix D.4,10.3  
Matrix Multiplication D.4.10.3, D.4.10.8  
Maxint 3.1.1.1  
MaxSig D.4.5, D.4.12  
Memavail Function 11.2.5

- Member-Group 5.3
  - syntax 5.3
- Memory Allocation Procedures 11.2
- Merge sorting D.4.5
- Microsecond Timer F.6
- MicroSeconds Data Type F.10
- MicroTimer Function F.6
- Millisecond Timer F.7
- MilliSeconds Data Type F.10
- Minimum Listing J-2
- Missing Symbol E.5.2
- Mod Operator A
- Mouse F.1
  - button F.5
  - plug F.5
- MouseLocation Procedures F.1.1
- MouseOdometer Procedure F.1.4
- MouseScaling Procedure F.1.3
- MouseThresh Procedure F.1.3
- MouseUpdates Procedure F.1.2
- Move Procedure E.9.3
- Move2D Procedure E.12.4
- Move3D Procedure E.12.4
- Moveleft Procedure 11.7.1
- MovePortTo Procedure E.9.1
- Moveright Procedure 11.7.2
- MoveTo Procedure E.9.3
- MoveTo2D Procedure E.12.4
- MoveTo3D Procedure
- MulC D.3.3.1, D.3.12
- MulC D.3.3.1, D.3.12
- MulS D.3.3.1, D.3.12
- MulX D.3.3.1, D.3.12
- Multiply D.3.3.1

**N**

- NaN D.2.1
- NaN Arithmetic D.2.4
- NaN Code D.2.1
- NaNCond D.4.11
- NaNDet D.4.11
- NaNIRR D.4.8, D.4.11
- NaNs 3.1.1.3, D.3.7
- Natural (base-e) logarithm D.3.10.1

Negation D. 3. 9. 2  
 Negative Zeros D. 2. 1  
 NegX D. 3. 9. 2, D. 3. 12  
 New Procedure 3. 3, 11. 2. 1, A  
 NewRgn Function E. 9. 11  
 Next-After D. 3. 9. 3  
 NextD D. 3. 9. 3, D. 3. 12  
 NextS D. 3. 9. 3, D. 3. 12  
 NextX D. 3. 9. 3, D. 3. 12  
 NextRandom D. 4. 3, D. 4. 12  
 Nil 3. 3, 4. 3. 4, 11. 2. 1  
 Noise Procedure F. 4  
 Nonsingular-transformations D. 4. 10. 1  
 Normal 10. 1. 5  
 NORMAL D. 3. 7. 1, D. 3. 12  
 Normalized Number D. 3. 7. 1  
 Not-a-Number D. 2. 1  
 Number 1. 4  
 NumClass D. 3. 7. 1, D. 3. 12  
 Numerical Comparisons 5. 1. 5. 1

*O*

Object File 9  
 Object of Pointer 4. 3. 4  
 ObscureCursor Procedure E. 9. 2  
 Odd Function 11. 4. 1  
 OffsetPoly Procedure E. 9. 15  
 OffsetRect Procedure E. 9. 6  
 OffsetRgn Procedure E. 9. 11  
 Open3DPort Procedure E. 12. 4  
 Opening a File 10. 1, 10. 1. 2-4  
 OpenPicture Function E. 9. 14  
 OpenPoly Function E. 9. 15  
 OpenPort Procedure E. 9. 1  
 OpenRgn Procedure E. 9. 11  
 Operands 5  
     compile-time 12. 2. 3  
     in expressions 5  
 Operators 5  
     compile-time 12. 2. 3  
     in expressions 5  
 Options, Code Generator Notes 12-4  
 Options, Code Generator (Table) Notes 12-7  
 Options, Compiler Notes 12-2

- Options, Compiler (Table) Notes 12-7
- Optimization Of If, Repeat, and While statements 12.3, 12.4
- Ord Function 3.1, 3.1.1.5, 3.1.2, 11.5.1
- Ord4 Function 3.1.1.2, 11.3.3
- Order of Evaluation of Operands 5.1.1
- Ordinal Functions 11.5
- Ordinal-Type 3.1
  - and ord function 11.5.1
  - and ord4 function 11.3.3
  - and pred function 11.5.4
  - and succ function 11.5.3
  - syntax 3.1
- Ordinal-Type-Identifier 3
- Ordinality 3.1
- Otherwise-Clause 6.2.2.2
  - syntax 6.2.2.2
- Output (Standard File) 10.3
- Output Expression in Write Procedure 10.3.3
- Output File in Write Procedure 10.3.3
- Output-Specs in Write Procedure 10.3.3
- Ovals, Graphic Operations E.9.8
- OVERFLOW D.3.8.2, D.3.12
- Overflow (Real Arithmetic) 3.1.1.3, D

*P*

- P754 D.3.1
- Packed Array of Char 5.1.5.6, 10.3.1.5, 10.3.3.6, 11.8
  - comparisons 5.1.5.6
  - fillchar procedure 11.8.3
  - scanning functions 11.8.1, 11.8.2
  - text-oriented I/O 10.3.1.5, 10.3.3.6
- Packed Data Types 3.1.1.6, 3.2
- Page Procedure 10.3.6
- PaintArc Procedure E.9.10
- PaintOval Procedure E.9.8
- PaintPoly Procedure E.9.16

PaintRect Procedure E. 9. 7  
PaintRgn Procedure E. 9. 12  
PaintRoundRect Procedure E. 9. 9  
Parameter 7. 1, 7. 3  
Parameter-Declaration Syntax Notes 7-2  
Parameter List Compatibility 7. 3. 5  
Parameter-Declaration 7. 3  
    syntax 7. 3  
Parameters in Procedure Call 6. 1. 2  
Pascal Compiler 12  
Pascal Diskette Description I-6  
Pascal Real Arithmetic D. 5. 2  
Pascal Workshop Files I  
Pattern Data Type E. 4. 3  
Pattern Transfer Mode E. 7. 1  
Patterns E. 4. 3  
Pen E. 5. 1  
Pen Routines E. 9. 3  
PenMode Procedure E. 9. 3  
PenNormal Procedure E. 9. 3  
PenPat Procedure E. 9. 3  
PenSize Procedure E. 9. 3  
Performance Penalty for Longint  
    values 3. 1. 1. 2  
PicComment Procedure E. 9. 14  
PicHandle Data Type E. 8. 1  
PicPtr Data Type E. 8. 1  
Picture Comments E. 8. 1  
Picture Data Type E. 8. 1  
Picture Frame E. 8. 1  
Picture Routines E. 9. 14  
Pictures E. 8. 1  
Pitch Procedure E. 12. 4. 2  
Pixel E. 4. 1  
Pixels Data Type F. 10  
Plus-EForm D. 4. 6, D. 4. 12  
Point Data Type E. 3. 2  
Pointer 4. 3. 4, 11. 2  
Pointer Function 3. 3, 11. 3. 4  
Pointer-Object-Symbol 4. 3. 4  
    syntax 4. 3. 4  
Pointer-Reference 4. 3. 4  
Pointer-Type 3. 3  
    conversions 11. 3. 3, 11. 3. 4  
    syntax 3. 3



- Pointer-Type-Identifier 3
- Points E. 3. 2
- Points, Calculations E. 9. 17
- Polar Coordinates D. 4. 3
- Polygon Data Type E. 8. 2
- Polygons E. 8. 2
  - calculations E. 9. 15
  - graphic operations E. 9. 16
- PolyHandle Data Type E. 8. 2
- Polynomial D. 3. 5
- PolyPtr Data Type E. 8. 2
- PorBits E. 5
- PortRect E. 5
- PortSize Procedure E. 9. 1
- Pos Function 11. 6. 2
- Power Switch F. 5
- P-QR-Record D. 4. 12
- Precedence of Operators 5
- Pred Function 3. 1, 11. 5. 4
- Predecessor 3. 1
- Predefined Identifiers A. 4
- Present Value D. 3. 10. 3
- Procedural Parameter 7. 3. 3
- Procedure 7. 1, 7. 3
- Procedure-and-Function-Declaration-  
Part 2. 1
  - syntax 2. 1
- Procedure-Body Syntax Notes 7-1
- Procedure-Declaration 7. 1
  - syntax 7. 1
- Procedure-Entry D. 3. 8. 3
- Procedure-Exit D. 3. 8. 3
- Procedure-Heading 7. 1
  - syntax 7. 1
- Procedure-Statement 6. 1. 2, 7. 1
  - syntax 6. 1. 2
- Procedures, Assembly Language E. 11. 4
- ProcEntry D. 3. 8. 3, D. 3. 12
- ProcExit D. 3. 8. 3, D. 3. 12
- Program 8
  - identifier 8. 1
  - segments 8. 3
  - syntax 8. 1
- Program-Heading 8. 1
  - syntax 8. 1

- Program-Parameters 8.1, 8.2
  - syntax 8.1
- Pseudo-inverse P D.4.10.3
- Pseudo-inverses D.4.10.1
- Pt2Rect Procedure E.9.6
- PtInRect Function E.9.6
- PtInRgn Function E.9.11
- PtToAngle Procedure E.9.6
- Purge 10.1.5
- Put Procedure 10.2.2-3
- Pwroften Function 11.4.10
- Pyramid E.12

*Q*

- QDProcs Data Type E.10
- QDProcsPtr Data Type E.10
- QDSample Program E.2.1, E.14.1
- QDSupport Unit E.15
- QNAN D.3.7.1, D.3.12
- QR-Condition D.4.10, D.4.10.10, D.4.12
- QR-Determinant D.4.10.8, D.4.10.10, D.4.12
- QR-Factor D.4.10.8, D.4.10.10, D.4.12
- QR Factorization D.4.10.9
- QR-Improve D.4.10.8, D.4.10.10, D.4.12
- QR-Residual D.4.10.8, D.4.10.10, D.4.12
- QR-Solve D.4.10.8, D.4.12
- QR-Solve finds D.4.10.10
- QR-TransDeterminant D.4.10.8, D.4.10.10, D.4.12
- QR-Transolve D.4.10.8, D.4.10.10, D.4.12
- Quadratic Equation D.3.5
- Qualifier 4.3
  - syntax 4.3
- QuickDraw E
- QuickDraw Data Types E.2.2, E.13.2
- QuickDraw Glossary E.16
- QuickDraw, Linking To Notes E-1
- QuickDraw Routines E.9
  - arcs E.9.10
  - bit transfer E.9.13
  - color drawing E.9.5
  - cursor handling E.9.2
  - customizing E.10
  - grafPorts E.9.1

- line drawing E. 9. 3
  - miscellaneous utilities E. 9. 18
  - ovals E. 9. 8
  - pen E. 9. 3
  - pictures E. 9. 14
  - points E. 9. 17
  - polygons E. 9. 15, E. 9. 16
  - rectangles E. 9. 6, E. 9. 7
  - regions E. 9. 11, E. 9. 12
  - rounded-corner rectangles E. 9. 9
  - text drawing E. 9. 4
  - wedges E. 9. 10
  - QuickDraw Sample Programs E. 2. 1,  
E. 14
  - QuickDraw Summary E. 13
  - QuickDraw, Text Notes E-1
  - QuickDraw, Using From Assembly  
language E. 11
  - Quiet NaN D. 3. 7. 1
  - Quo D. 3. 3. 2, D. 3. 12
  - Quoted-Character-Constant 1. 6. 1  
syntax 1. 6. 1
  - Quoted-String-Constant 1. 6  
syntax 1. 6
- R*
- RampContrast Procedure F. 3. 1
  - RandModulus D. 4. 3, D. 4. 12
  - Random Function E. 9. 18
  - Random Number Generator D. 3. 10. 5
  - RandomX D. 3. 10. 5, D. 3. 12
  - Range-Checking 3. 1. 3, 12. 1
  - Rank-Deficient D. 4. 10. 2
  - Read Procedure 10. 3. 1
  - Readln Procedure 10. 3. 2
  - Real 1. 4, 3. 1. 1. 3, 10. 3. 1. 3,  
10. 3. 3. 4, 11. 3-4, D  
arithmetic D  
constant 1. 4  
data type 3. 1. 1. 3  
data type and round function 11. 3. 2  
values 3. 1. 1. 3  
values and write procedure D  
values in text-oriented I/O  
10. 3. 1. 3, 10. 3. 3. 4, D

- RealPrecision D. 4. 2, D. 4. 12
- Real-Type 3. 1
  - syntax 3. 1
- Real-Type-Identifier 3
- Record 3. 2. 2, 4. 3. 2
  - field 3. 2. 2, 4. 3. 2
  - number and seek procedure 10. 2. 4
  - or file 10. 2
  - reference 4. 3. 2
  - reference in with statement 6. 2. 4
- Record-Oriented I/O 10. 2
- Record-Type 3. 2. 2
  - new procedure 11. 2. 1
  - syntax 3. 2. 2
- Rectangle Calculation Routines E. 9. 6
- Rectangle Data Type E. 3. 3
- Rectangles E. 9. 9
- Rectangles E. 3. 3
  - graphic operations E. 9. 7
- RectInRgn Function E. 9. 11
- RectRgn Procedure E. 9. 11
- Recursion 7. 1-2
- Redeclaration of Identifier 2. 2. 2,  
2. 2. 4
- Region Data Type E. 3. 4
  - calculations E. 9. 11
  - graphic operations E. 9. 12
- Regression D. 4. 10. 7
- Regular-Unit Syntax Notes 9-2
- Relational Operators 5. 1. 5
- Relaxed Order of Declarations Notes 2-1
- Release D. 4. 4
- Release Procedure 11. 2. 4, A
- RelX D. 3. 6, D. 3. 12
- RelOp D. 3. 6, D. 3. 12
- Remainder D. 3. 3. 2
- RemX D. 3. 3. 2, D. 3. 12
- Repeat-Statement 6. 2. 3. 1
  - optimization 12. 4
  - syntax 6. 2. 3. 1
- Repeating Keys F. 5. 5
- RepeatRate Procedure F. 5. 5
- Repetitive-Statement 6. 2. 3
  - syntax 6. 2. 3
- Reserved Words 1. 1

Reset Procedure 10.1, 10.1.5, A  
Residual D.4.10.6, D.4.10.10  
Result-Type 7.2  
    syntax 7.2  
Rewrite Procedure 10.1.4  
RgnHandle Data Type E.3.4  
RgnPtr Data Type E.3.4  
RintX D.3.9.1, D.3.12  
Roll Procedure E.12.4.2  
Rotation E.12  
Round D.2.4  
Round Function 11.3.2, D  
Rounding D.2.2  
RoundDir D.3.12  
Rounding Direction D.3.8.1  
Rounding Error D.4.9  
Rounding Function D.3.8.1  
Rounding in Real Arithmetic D  
Rounding precision D.3.8  
Rounding Direction D.3.8.1.  
RoundDir D.3.8.1  
Roundoff Errors D.4.10.4  
RoundPrecision D.4.2, D.4.12  
Round to Integral Value D.3.9.1  
Row Width E.4.1

**S**

S2Dec D.3.4.2, D.3.12  
S2Str D.3.4.2, D.3.12  
S2X D.3.4.1, D.3.12  
Sane D.1  
SANE Environ D.3.11, D.3.12  
ScalbX D.3.9.4, D.3.12  
Scale Procedure E.12.4.2  
Scale-Factor 1.4  
    syntax 1.4  
ScalePt Procedure  
Scan Function A  
Scaneq Function 11.8.1  
SCanne Function 11.8.2  
Scope 2.2  
    of standard objects 2.2.5  
Screen 10.3, 10.3.7.2, F.3  
    contrast F.3.1  
    cursor control 10.3.7.2, F.2

- fading F. 3. 2
- physical 10. 3
- ScreenContrast Data Type F. 10
- ScreenSize Procedure F. 3
- ScrollRect Procedure E. 9. 13
- Seconds Data Type F. 10
- SectRect Function E. 9. 6
- SectRgn Procedure E. 9. 11
- Seed D. 3. 10. 5
- Seek Procedure 10. 2. 3
- Segment Keyword A
- Segmentation 8. 3, Notes 9-1
- Segments 8. 3, 9. 1, 9. 2. 1
- Selector in Case Statement 6. 2. 2. 2
- Series of payments D. 4. 8
- Set 3. 2. 3, 5. 1. 4, 5. 1. 5. 4, 5. 3
  - comparisons 5. 1. 5. 4
  - membership testing 5. 1. 5. 5
  - operators 5. 1. 4
  - values 5. 3
- Set-Constructor 5, 5. 3
  - syntax 5. 3
- Set-Type 3. 2. 3
  - syntax 3. 2. 3
- SetClip Procedure E. 9. 1
- SetContrast Procedure F. 3. 1
- SetCursor Procedure E. 9. 2
- SetDateTime Procedure F. 8
- SetDimContrast Procedure F. 3. 2
- SetEmptyRgn Procedure E. 9. 11
- SetEnv D. 3. 8. 1, D. 3. 8. 2 D. 3. 12
- SetFadeDelay Procedure F. 3. 2
- SetHlt D. 3. 8. 2, D. 3. 12
- SetHlt Address D. 3. 8. 2, D. 3. 11, D. 3. 12
- SetLegends Procedure F. 5. 1
- SetOrigin Procedure E. 9. 1
- SetPenState Procedure E. 9. 3
- SetPort Procedure E. 9. 1
- SetPort3D Procedure E. 12. 4
- SetPortBits Procedure E. 9. 1
- SetPrecision D. 4. 2, D. 4. 12
- SetPt Procedure E. 9. 17
- SetPt2D Procedure E. 12. 4
- SetPt3D Procedure E. 12. 4
- SetRect Procedure E. 9. 6

- SetRectRgn Procedure E. 9. 11
- SetRnd D. 3. 8. 1, D. 3. 12
- SetRepeatRate Procedure F. 5. 5
- SetStdProcs Procedure E. 10
- SetTimeStamp Procedure F. 9
- SetVolume Procedure F. 4
- SetXcp D. 3. 8. 2, D. 3. 12
- Sign D. 3. 4. 2, D. 3. 12, D. 4. 7, D. 4. 12
- Shared Intrinsic-Unit Notes 9-1
- ShowCursor Procedure E. 9. 2
- ShowPen Procedure E. 9. 3
- Sig D. 3. 4. 2, D. 3. 12, D. 4. 7, D. 4. 12
- SigDig D. 3. 12
- SIGDIGLEN D. 3. 12
- Sig-FFarm D. 4. 6
- Sig-FForm D. 4. 12
- Sign 1. 4
  - syntax 1. 4
- Sign D. 3. 7. 1
- SignDfX D. 4. 4
- SignOfX D. 4. 12
- Sign Manipulation D. 3. 9. 2
- Signalling NaN D. 3. 7. 1
- Signed Zero 3. 1. 1. 3
- Signed-Number 1. 4
  - syntax 1. 4
- Silence Procedure F. 4
- Simple-Expression 5
  - syntax 5
- Simple-Statement 6. 1
  - syntax 6. 1
- Simple-Type 3. 1
  - syntax 3. 1
- Simple-Type-Identifier 3
- Sin Function 11. 4. 4
- Sine D. 3. 10. 4
- Single D. 3. 12
- Single, Double, Comp Extended D. 3. 2
- Singular D. 4. 10. 1
- SinhX D. 4. 3, D. 4. 12
- SinX D. 3. 10. 4, D. 3. 12
- Size-Attribute 3. 1. 1. 6
  - syntax 3. 1. 1. 6
- Sizeof Function 11. 7. 3
- Skew Procedure E. 12. 4. 2

SNAN D. 3. 7. 1, D. 3. 12  
 Solving a system of linear equations D. 4. 10. 3  
 Sorted D. 4. 5  
 Source Transfer Mode E. 7. 1  
 SpaceExtra Procedure E. 9. 4  
 Speaker F. 4  
 SpeakerVolume Data Type F. 10  
 Special Symbols 1. 1  
 Sqr Function 11. 4. 3  
 Sqrt Function 11. 4. 8, D  
 SqrtX D. 3. 3. 3, D. 3. 12  
 Square Root D. 3. 3. 3  
 Stable D. 4. 5  
 Stack Space and Memavail Function  
     11. 2. 5  
 Standard Apple Numeric Environment D-1  
 Standard errors D. 4. 10. 7  
 Standard Procedures and Functions  
     for I/O 10  
     10, 11  
 Standard Simple-Types 3. 1  
 Statement 6  
     syntax 6. 1  
 Statement-Part 2. 1  
     syntax 2. 1  
 Statistical Computatins D. 4. 10. 7  
 StdArc Procedure E. 10  
 StdBits Procedure E. 10  
 StdComment Procedure E. 10  
 StdGetPic Procedure E. 10  
 StdLine Procedure E. 10  
 StdOval Procedure E. 10  
 StdPoly Procedure E. 10  
 StdPutPic Procedure E. 10  
 StdRect Procedure E. 10  
 StdRgn Procedure E. 10  
 StdText Procedure E. 10  
 StdTxMeas Function E. 10  
 Str2C D. 3. 4. 2, D. 3. 12  
 Str2D D. 3. 4. 2, D. 3. 12  
 Str2S D. 3. 4. 2, D. 3. 12  
 Str2X D. 3. 4. 2, D. 3. 12  
 Str2Dec D. 3. 12  
 String 1. 6, 3. 1. 1. 6, 4. 3. 1, 5. 1. 5. 3,  
     10. 3. 1. 4, 10. 3. 3. 5, 11. 6, A



- character 4.3.1
- comparisons 5.1.5.3
- concatenation 11.6.3
- constant 1.6, 3.1.1.6
- constant comparisons 5.1.5.3
- length function 11.6.1
- procedures and functions 11.6
- reference 4.3.1
- substring copying 11.6.4
- substring deletion 11.6.5
- substring insertion 11.6.6
- substring search 11.6.2
- values in text-oriented I/O
  - 10.3.1.4, 10.3.3.5
- String-Character 1.6
  - syntax 1.6
- String-Type 3.1.1.6
  - syntax 3.1.1.6
- String-Type-Identifier 3
- StringWidth Function E.9.4
- Structured-Statement 6.2
  - syntax 6.2
- Structured-Type 3.2
  - syntax 3.2
- Structured-Type-Identifier 3
- StuffHex Procedure E.9.18
- Systems of linear equations D.4.10.9
- Style D.3.4.2, D.3.12
- SubPt Procedure E.9.17
- Subrange-Type 3.1.3
  - syntax 3.1.3
- Subtract D.3.3.1
- SubC D.3.3.1, D.3.12
- SubD D.3.3.1, D.3.12
- SubSx D.3.3.1, D.3.12
- SubX D.3.3.1, D.3.12
- Succ Function 3.1, 11.5.3
- Successor 3.1
- Swap D.4.5
- Syntax Diagrams, Complete Collection
  - C
- Syntax Diagrams, Explanation Preface
- System Intrinsic Library 9.2.2, 12.1

*T*

- Tag Constants In New And Dispose
  - procedures 11.2.1-2
- Tag-Field 3.2.2
- Tag-Field-Type 3.2.2
  - syntax 3.2.2
- Tangent D.3.10.4
- TanhX D.4.3, D.4.12
- TanX D.3.10.4, D.3.12
- Term 5
  - syntax 5
- TestHlt D.3.8.2, D.3.13
- TestXcp D.3.8.2, D.3.12
- Testing Set Membership 5.1.5.5
- Text E.5.2
- Text Type 3.2.4, 10.1.2, 10.3
- Text-Drawing Routines E.9.4
- Text-Oriented I/O 10.3
- TextFace Procedure E.9.4
- Textfile 10.1.2, 10.3, Ar
- TextFont Procedure E.9.4
- TextMode Procedure E.9.4
- TextSize Procedure E.9.4
- TextWidth Function E.9.4
- Three-Dimensional Graphics. See
- TFP-byte D.4.4, D.4.12
- TFP-Comp D.4.4, D.4.12
- TFP-Double D.4.4, D.4.12
- TFP-Extended D.4.4, D.4.12
- TFP-integer D.4.4, D.4.12
- TFP-longint D.4.4, D.4.12
- TFP-real D.4.4, D.4.12
- Graf3D
- Time F.8, F.9
- Time Stamp F.9
- Timer Function (Millisecond Timer)
  - F.7
- Timers F.6, F.7
- TimeStamp Function F.9
- TimeToDate Procedure F.9
- TONEAREST D.3.8.1, D.3.12
- TOWARDZERO D.3.7.1, D.3.12

- Trail-Point D. 4. 6, D. 4. 12
- Transfer Functions 11. 3
- Transfer modes E. 7. 1
- TransForm Procedure E. 12. 4. 2
- Transformation D. 4. 10. 1
- Transformation Matrix E. 12
- Translate Procedure E. 12. 4. 2
- Transpose D. 4. 10. 3
- Treearch Procedure A
- Trigonometric Functions D. 3. 10. 4
- Trunc D. 2. 4
- Trunc Function 11. 3. 1, A, D
- Turtlegraphics Unit A
- Type 3
  - compatibility and identity 3. 4
  - syntax 3
- Type-Conversion Notes 3-1
- Type-Declaration 3
  - syntax 3
- Type-Declaration-Part 2. 1, 3. 5
  - syntax 2. 1

//

- UCSD Pascal A
- Unary Arithmetic Operators 5. 1. 2
- UNDERFLOW D. 3. 8. 2, D. 3. 12
- Underscore Character
- UnionRect Procedure E. 9. 6
- UnionRgn Procedure E. 9. 11
- Uniqueness D. 4. 10. 3
- Unit 9
  - intrinsic 9. 2
  - regular 9. 1
- Unit-Heading Syntax Notes 9-2
- Unit, Intrinsic Notes 9-1
- Univtype Notes 7-2
- UNORD D. 3. 6, D. 3. 12
- Unordered D. 3. 6
- Unsigned-Constant 5
  - syntax 5
- Unsigned-Integer 1. 4
  - syntax 1. 4
- Unsigned-Number 1. 4
  - syntax 1. 4

Unsigned-Real 1.4  
    syntax 1.4  
Untyped File 3.2.4, 10.1.1-2, 10.4  
    I/O 10.4  
UPWARD D.3.8.1, D.3.12  
Uses D.3.1, D.4.1  
Uses-Clause 8.1, 9.1.1-2, 9.2, 9.3  
    syntax 8.1  
Utility Procedures D.4.4

✓

Value Parameter 7.3.1  
ValidPrefix D.3.12  
Variable 4  
Variable Parameter 7.3.2, A  
Variable-Declaration 4.1  
    syntax 4.1  
Variable-Declaration-Part 2.1  
    syntax 2.1  
Variable-Identifier 4.1  
    syntax 4.1  
Variable-Reference 4.2  
    syntax 4.1  
Variant 3.2.2  
    records, new procedure 11.2.1  
    syntax 3.2.2  
Variant-Part 3.2.2  
    syntax 3.2.2  
Vectors and Linear Transformations D.4.10.1  
Vector space D.4.10.1  
Vertical Retrace F.3  
VHSelect Data Type E.3.2  
ViewAngle Procedure E.12.4.1  
Viewing Pyramid E.12  
ViewPort Procedure E.12.4.1  
VisRgn E.5  
Volume Function F.4

✓

Wedges, Graphic Operations E.9.10  
While-Statement 6.2.3.2  
    optimization 12.4  
    syntax 6.2.3.2

With-Statement 6.2.4  
    syntax 6.2.4  
Wordstream Type A  
Write Procedure 10.3.3, A  
    with real values D  
Write-Protection of File 10.1.5  
Writeln Procedure 10.3.4, A

*X*

X2C D.3.4.1, D.3.12  
X2D D.3.4.1, D.3.12  
X2I D.3.4.1, D.3.12  
X2L D.3.4.1, D.3.12  
X2LDec D.4.7, D.4.12  
X2S D.3.4.1, D.3.12  
X2X D.3.4.1, D.3.12  
X2Dec D.3.4.2, D.3.12  
X2Str D.3.4.2, D.3.12  
XForm Matrix E.12  
XpwrI D.3.10.2, D.3.12  
XpwrY D.3.10.2, D.3.12  
XorRgn Procedure E.9.11

*Y*

Yaw Procedure E.12.4.2

*Z*

ZERO D.3.7.1, D.3.12  
Zero D.2.1, D.3.7.1  
Zero of a Nonlinear Function D.4.9  
Zero of polynonial function D.4.9  
Zero Signed 3.1.1.3

*CHARACTERS*

\$C Compiler Commands 12.1  
\$O Compiler Commands 12.1  
\$DECL Compiler Command 12.2.1  
\$E Compiler Command 12.1  
\$ELSEC Compiler Command 12.2.4  
\$ENDC Compiler Command 12.2.4  
\$I Compiler Command 12.1

\$IFC Compiler Command 12.2.4  
\$L Compiler Commands 12.1  
\$R Compiler Commands 3.1.3, 12.1  
\$\$ Compiler Command 8.3, 9.1, 9.2,  
12.1  
\$SETC Compiler Command 12.2.1  
\$U Compiler Commands 9.1.2, 9.2.2,  
12.1  
\$X Compiler Commands 12.1  
0, Signed 3.1.1.3  
16-Bit Integer Arithmetic 3.1.1.1-2,  
11.3.3  
32-Bit Integer Arithmetic 3.1.1.2,  
11.3.3  
3D Graphics. See Graf3D.  
@ Operator 3.3, 5.1.6



## Notes



